





Specifications

Finishing Sander

-  Double Insulation
-  Variable Speed (BO4900V)
-  Dust Collecting
-  Hook & Loop (BO4900V, BO4900)

Pad size	115 mm x 229 mm (4-1/2" x 9")
Abrasive paper size	
Clamp	115 mm x 280 mm (4-1/2" x 11")
Hook & loop*	115 mm x 232 mm (4-1/2" x 9-1/8")
Continuous rating	
Input	330 W
Orbits per minute (min ⁻¹)	4,000 – 10,000 (BO4900V) 10,000 (BO4900, BO4901)
Sanding stroke rate (min ⁻¹)	8,000 – 20,000 (BO4900V) 20,000 (BO4900, BO4901)
Orbit dia.	2.6 mm
Overall length	289 mm (11-3/8")
Net weight	2.8 kg (2.6 lbs)
Power supply cord	2.5 m (8.2 ft.)

* Model BO4901 use with pad set (optional accessory)

Specifications may differ from country to country.

Dimensions

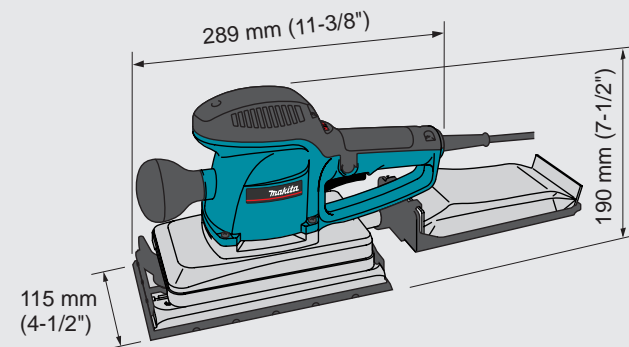

Standard equipment





Finishing Sander

	North America	Other Countries
	Part No.	Part No.
Pad set (For model BO4901)	193522-8	193521-0
Pad set (hook & loop) (For model BO4900V, BO4900)	193524-4	193523-6
Paper dust bag holder (For model BO4900V, BO4900) Paper dust bag holder comes with a paper dust bag.	193525-2	193294-5
Abrasive paper #120 (pre-punched) 1pc.	A-14093 (10pcs per pkg.)	

Items of standard equipment may differ from country to country.

Optional accessories

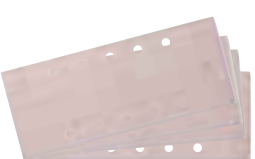
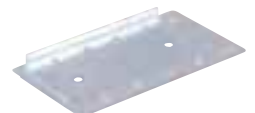
Finishing Sander

Abrasive paper (10per pkg.)	Grit	Part No.	Dust bag complete	
	60	794210-6		Part No. 151517-7
	80	794470-0		
	100	794209-1	Paper dust bag (5per pkg.) 	Part No. Part No. North America 193526-0 Other Countries 193293-7
	120	794212-2		
	150	794213-0		
	180	794211-1		
Abrasive paper (10per pkg. Pre-punched) 	60	A-14065	Punch plate 	Part No. 192523-3
	80	A-14071		
	100	A-14087		
	120	A-14093		
	150	A-14102		
	180	A-14118		
Abrasive paper (5per pkg. Pre-punched, hook & loop) 	60	A-14130	Dust nozzle complete	Part No. 151518-5
	80	A-14146		
	100	A-14152		
	120	A-14168		
	150	A-14174		
	180	A-14180		
	240	A-14196	Joint 25	192349-3
			Joint (for Festo)	417408-5



A world's leading manufacturer of power tools

-  Double Insulation
-  Hook & Loop (BO4900V, BO4900)
-  Dust Collecting
-  Variable Speed (BO4900V)

Finishing Sander

Model BO4900V, BO4900, BO4901

*Newest Finishing Sanders from Makita
Minimized Vibration, Ergonomic Handles
and Efficient Dust Collection System for More
Comfortable and More Controlled Operations.*



Makita Corporation

3-11-8, Sumiyoshi-cho, Anjo, Aichi 446-8502, Japan

PRINTED IN JAPAN Z14316-2 2002-2



Finishing Sander



1. Soft grip handle provides a non-slip surface for comfortable operation (Model BO4900V only)

2. Variable Speed Control (Model BO4900V only)



Variable Speed Control Dial allows you to select the optimum speed for the material of work piece.

Performance Data

Note: It may differ under some conditions.

Volume of sanding

■ Work piece : spruce
With abrasive paper #120

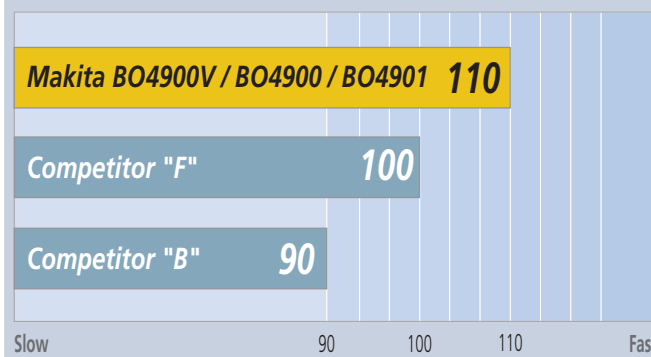

Numbers in chart are relative values when setting competitor "F's" capacity as 100.

3. Ergonomic Grip & Housing top



The knob-style front handle and the low housing top of round design fit your palms perfectly for easy and comfortable handling.

4. Large Clamping Lever



For quick and easy changing of abrasive paper.

5. Hook-and-Loop abrasive paper



FESTO and BOSCH abrasive papers can be used for BO4900V and BO4900. Papers for Makita 9046 are also applicable for these two models.

6. Through-the-Pad Dust Collection System

Extra-efficient dust collection for dust-free operation: Powerful suction through 10 pre-punched holes of abrasive paper and pad into dust bag or vacuum cleaner.

7. Easy connecting with vacuum cleaner

Can be connected to \varnothing 28 mm hose without any attachment.

8. Paper dust bag (Model BO4900V, BO4900)

For easy disposal of collected dust.