

The Gardening
Catalogue
2024

FISKARS





Over 375 years of history are proof of our commitment to quality. Fiskars products are ingeniously functional, uniquely user-friendly, impressively long-lasting and aesthetically iconic.

The gardening catalogue

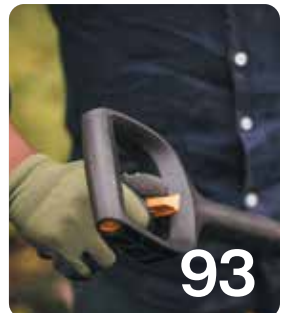
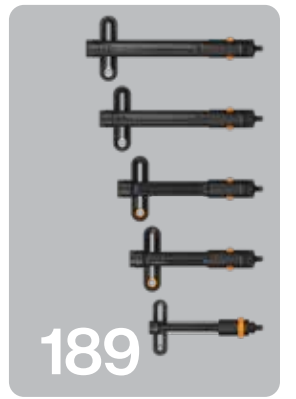

- 8 **New launches 2024**
- 10 **Seasonal calendar**
- 12 **Plant, grow, harvest**
Tips for seasonal planting, growing and harvesting
- 16 **Outdoor cooking**
Norden Outdoor cooking novelties
- 22 **Plant Care**
Pruners X-series™ · Plus · Solid™
· Professional Pruners · Fingerloop · Solid™ snips · Other
Loppers PowerGear™ X
· PowerGear™ · SmartFit™
· SingleStep™ · Other
Hedge Shears PowerGear™ X
· SmartFit™ · PowerLever™ · Other
Tree pruners PowerGear™ X
· Other Tree Pruners & Accessories
Scissors Classic · ReNew
- 60 **Lawn Care**
Rakes
Xact™ · Ergonomic™ · Classic · White · Solid™
Grass Shears
PowerLever™ · Servo-System™
· SmartFit™ · White · Solid™
Weed Pullers

Xact™ · SmartFit™ · White · Solid™
Classic & Solid™ Yard Tools
Classic · Ergo™ · Solid™
Reel Mowers StaySharp™

- 78 **Soil Care**
Growing & Planting
Xact™ · Ergo™ · Solid™
Harvesting
X-series™ · Plus™ · Solid™
Shovels, Spades & Forks
Xact™ · Ergonomic™ · White · Solid™
QuikDrill™
Soil Care Tools
Classic · Xact™ · Ergonomic™
· White · Solid™
Nursery Tools
Xact™ · Premium Planters™ · Ergo™
· White · Solid™

122 **Yard Cleaning**
White · Solid™

128 **Kids Tools**

132 **Fiskars QuikFit™**
Click & Reach · Click & Clean
· Click & Grow

146 **Wood Preparation**
Axes · Norden Axes · X-series™
Axes

WoodXpert™ Wood handling tools · Felling levers · Brush hooks
· Log hook & tongs · Sappies
· Yard clearing tools
Saws · Plus saws · Xtract™ saws · Fixed blade saws
Other tools · Splitting tools, Sledge Hammers & Wedges · Knives

176 **Watering**
Waterwheels · Hoses · Sprinklers
· Spray Nozzles · Connectors
· Accessories · Sets

213 **Fiskars Car Tools**
SnowXpert™ · Solid™

216 **Fiskars Snow Tools**
X-series™ · SnowXpert™
· Classic snow tools

222 **Accessories**

225 **Hardware Tools**
(see separate index on page 229)

271 **Maintenance & Spare Parts**

Please note! All the measurements portrayed in the catalogue are products in packaging measurements.

**We believe that
happiness is yours to
grow.**

We take action for the environment

Doing what we love brings us happiness. To really enjoy the activities we love, and make a positive impact beyond our homes, Fiskars takes action for the environment. Every product detail is designed for the best of the user and the environment, increasing sustainability and overall happiness.

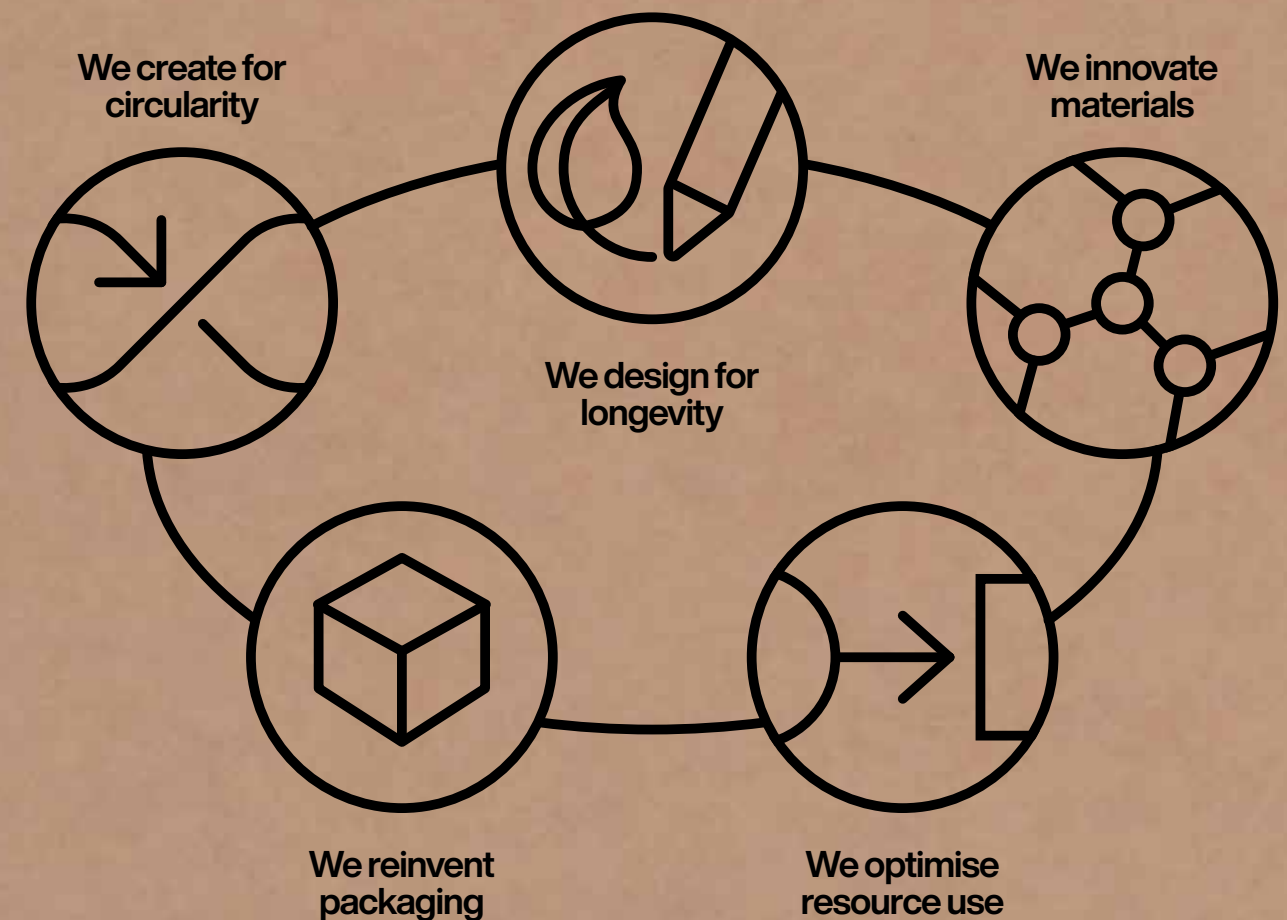

New gardening products 2024

Axes
Global stick tools
Indoor gardening
Norden
Watering



Yearly Calendar for gardening products

Tools for winter

While winter may be a time for rest in the garden, it can also call for snow clearing and a need for firewood.



1057076 Solid™ Spreader



1051143 Norden Chopping
Axe N10



1057177 X-series™ Snow shovel

Tools for autumn

Fall is the time to enjoy the fruits and veggies of our labour and prepare for upcoming winter.

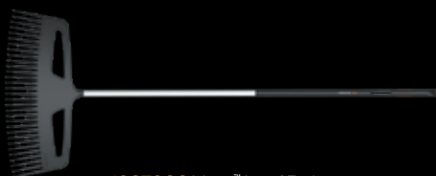

1027036 Xact™ Leaf Rake



1001414 QuikFit™
Gutter Cleaner



1062831 Plus Garden
Harvesting Basket

Right tools for every season

Tools for spring

Spring is the time for big changes in the garden, when preparation is a must for the upcoming growing season.



1020187 PowerGear™ X Bypass Lopper,
MLX94



1057175 X-series™ PowerGear
Pruner bypass LP961



1066729 Xact™ Pointed Spade

Tools for summer

Summer is the time for enjoying your garden and supporting growth with care and watering.



1020126 Xact™ Weed Puller



1000591 StaySharp™
Max Reel Mower



1065482 Spray gun multi,
Front control

Plant, grow, harvest.

Designed for **happy** planting & harvesting

Nothing tastes better than freedom and independence. No wonder more and more people (especially, in urban areas) are growing their own vegetables and fruit – whether on the smallest balcony, in the seasonal garden or on their own expansive plot of land. We show how easy it is to supplement supermarket shopping with your own produce.

The balcony: For the minimalist

From classic planter boxes to vertical gardening or a potato tower – the balcony offers more space for culinary self-fulfilment than one might initially think. Nevertheless, vegetables, fruit, and herbs on the balcony should be one thing above all: robust and high-yielding.



WHAT GROWS ON A SOUTH-FACING BALCONY?

Welcome to the sunny side of life with the best conditions for a small, self-catering existence. From spring to autumn everything that grows in full sun can be sown and harvested on a south-facing balcony.

However, it can even get too hot for them. Therefore, it is best to provide shade, a sunshade is usually sufficient. Large planters, pots and boxes store water well, so that you don't have to water all the time.

SOUTH



Tomatoes
Strawberries
Rosemary
Courgettes
Bell peppers
Chillis
Peppermint
Chives
Beans
Cucumbers

NORTH



Rocket
Spinach
Ramsons
Chard
Kohlrabi
Radishes
Mache

WHAT GROWS ON A NORTH-FACING BALCONY?

Imagine you live on the Mediterranean. Then someone suddenly transports you to cold climates. You would die, just like plants and herbs from the Mediterranean. So with rosemary or oranges you don't even need to try it on the north balcony. Nevertheless, some things can grow there. It is best not to place the containers directly on the ground, but rather hang them on a railing or in a hanging basket. A bonus: here the plants are more likely to forgive you if you forget to water them.

The seasonal garden: For the part-time self-supporter



Among the top five favourite gardening activities, planting and cultivating fruit and vegetables sits far in the lead. Many people dream of having their own garden, however few can make it a reality. This is why more and more hobby gardeners are renting a seasonal garden.

Here, as the name suggests, it is usually possible to rake, weed and harvest from March to November. Most plots are available in different sizes (from approx. 25 m² to 80 m²). Depending on space and taste, any fruit and vegetables can be planted.



CHOICE OF SUITABLE OPTIONS

Onions
Potatoes
Lettuce
Carrots

Sweetcorn
Broccoli
Parsley
Gooseberries



Create a dance of colour with bulbs

The last day of winter easily becomes the first day of spring if you have planted early spring bulbs like snowdrops or galanthus in the autumn months. As spring progresses to summer you can enjoy gently nodding daffodils, vibrant tulips or majestic alliums that impress every year. With these planting tips, next spring is sure to be vibrant and colourful.

PLANTING TIPS FOR TULIP BULBS

1. Fill the planter to about three quarters with soil. Dig a small hole for the bulb.
2. Place the bulb in the soil. Rule of thumb: flower bulbs must be planted three times as deep as the bulb is tall.
3. Cover the bulb loosely with soil. Only water a little, as the bulb won't develop well if too much liquid is added, or even rots.
4. All you need now is a little patience, and in no time you'll be able to enjoy the flowerage.

Planting time: September to December
Blooming period: March to June



The XXL garden: For the all-rounder

No space problems, enough distance and sufficient light – we pay tribute to large gardens. Here you can let off steam and plant what you like all year round. Those who also try their hand at winter vegetables will not only save themselves a trip to the supermarket in the colder season, they'll also do something for their good conscience, as exotic, imported fruit and vegetables often have been transported long distances.

WHAT ARE TYPICAL WINTER VEGETABLES?

Root vegetables: beetroot, parsnips, swede.

Leafy vegetables: mache, endive, chicory.

Cabbage: Curly kale, white cabbage, red cabbage.

WILL MY VEGETABLES FREEZE TO DEATH IN WINTER?

While some of us take out our winter socks at temperatures below 20 degrees, most winter-proof vegetables don't even mind a light blanket of snow. Lettuce leaves freeze in frost, but they also thaw quickly. Wait to harvest them, as they could become mushy.



Norden

Lasting Nordic design, inspired by nature

Norden draws inspiration from Nordic nature, culture and traditions and then reinterprets them in a modern way. The range captures the Nordic way of living; progressive, yet strongly rooted in heritage. The range consists of cast iron and stainless steel cookware, premium kitchen knives, outdoor cooking tools and utensils.



Norden outdoor cooking tools features & benefits



DESIGNED IN FINLAND



- Grill utensils**
- 1 Solid, premium wood**
Oak and heat-treated birch wood are sourced from responsibly managed forests.
 - 2 Premium stainless steel for ultimate performance**
Premium stainless steel for durability and high temperature use.
 - 3 Wood for non-stick cookware**
All wooden grilling utensils are suitable for non-stick cookware surfaces.
 - 4 Perfectly balanced**
Perfect balance for comfort and control in use.



Grill cookware

- 1 Durable cast iron**
Durable cast iron pot and plate are ideal for a wide variety of cooking styles.
- 2 Easy to clean**
THERMIUM™ mineral treatment makes inner surface very easy to clean and care for.
- 3 High temperatures**
Heatproof up to 270°C, not recommended for use with metal utensils.
- 4 Premium stainless steel**
Premium stainless steel lid for lasting durability.
- 5 Stainless steel steaming basket**
Multi-function cooking: use it as a grill basket for preparing delicate ingredients, as a steamer or as a colander.
- 6 Norden Grill Chef system**
Use it with the Norden Grill Chef Pot for 1- or 2-layer steaming on your barbeque grill or indoor kitchen.
- 7 Stackability**
Part of the stackable Norden Grill Chef system.



Cooking basket



Cooking plate



Grill pot



Norden outdoor cooking tools

Grill Chef pot					Art.no. 1066430	EAN 6 424002 016311
Height: 13,1cm	Length: 33,2cm	Width: 34 cm	Weight: 5,86kg	Retail box: 1	Oldart.no. -	



- Durable cast iron pot is ideal for a wide variety of cooking styles on the grill and indoors and for easy mixing
- Thermium™ mineral treatment makes inner surface very easy to clean and care for
- Premium stainless steel lid
- Part of the stackable Norden Grill Chef system
- Suitable for induction, ceramic, gas and traditional hobs. Also for open fire and different grills

Grill Chef Steel basket/steamer					Art.no. 1066431	EAN 6 424002 016328
Height: 8,1cm	Length: 32cm	Width: 32,2cm	Weight: 1,05kg	Retail box: 1	Oldart.no. -	



- For multi-function cooking: use it as a grill basket for preparing delicate ingredients, as a steamer or as a colander
- Premium stainless steel for lasting durability
- Use it with the Norden Grill Chef Pot for 1- or 2-layer steaming on your barbeque grill or indoor kitchen
- Part of the stackable Norden Grill Chef system

Grill Chef cooking plate					Art.no. 1066432	EAN 6 424002 016335
Height: 4,3cm	Length: 32,2cm	Width: 32,2cm	Weight: 2,64kg	Retail box: 1	Oldart.no. -	



- Durable cast iron plate is ideal for cooking pancakes, fish or vegetables on the grill or over open flame
- Two layers of enamel and unique Thermium™ mineral treatment makes cooking surface very easy to clean and care for
- Bottom legs provide stability while cooking and serving
- Part of the stackable Norden Grill Chef system
- Suitable for open fire and different grills

Grill Chef spatula					Art.no. 1066425	EAN 6 424002 016267
Height: 3cm	Length: 44,4cm	Width: 8,6cm	Weight: 0,39kg	Retail box: 1	Oldart.no. -	



- Solid, premium stainless steel head is thinly shaped to easily flip food
- Serrated edge cuts ingredients
- Convenient loop for hanging when not in use
- Handle made of high-quality, heat-treated birch

Grill Chef tongs					Art.no. 1066426	EAN 6 424002 016274
Height: 3cm	Length: 44,4cm	Width: 8,6cm	Weight: 0,38kg	Retail box: 1	Oldart.no. -	



- Solid, premium stainless steel tongs have a non-twisting joint for precision
- Serration enables good grip
- Convenient loop for hanging when not in use
- Handle made of high-quality, heat-treated birch

Grill Chef fork

Height: **2,9cm** Length: **45,2cm** Width: **8,7cm** Weight: **0,31kg** Retailbox: **1**

Art.no. **1066427**

Oldart.no. -



- Solid, premium stainless steel fork easily grabs large ingredients
- Convenient loop for hanging when not in use
- Handle made of high-quality, heat-treated birch

Grill Chef spoon wooden

Height: **2,5cm** Length: **43,2cm** Width: **7,7cm** Weight: **0,13kg** Retailbox: **4**

Art.no. **1066428**

Oldart.no. -



- A beautiful piece for grilling, cooking and serving
- Made of solid, high-quality oak
- Natural variation in wood colour and grain makes each product unique
- Perfectly balanced design
- Safe for use with non-stick cookware

Grill Chef spatula wooden

Height: **2,5cm** Length: **43,2cm** Width: **7,7cm** Weight: **0,13kg** Retailbox: **4**

Art.no. **1066429**

Oldart.no. -



- A beautiful piece for grilling, cooking and serving
- Made of solid, high-quality oak
- Natural variation in wood colour and grain makes each product unique
- Perfectly balanced design
- Safe for use with non-stick cookware

Grill Chef tools set 2pcs

Height: **3,3cm** Length: **47,3cm** Width: **14,2cm** Weight: **0,78kg** Retailbox: **1**

Art.no. **1066552**

Oldart.no. -



- Spatula's solid, premium stainless steel head is thinly shaped to easily flip food
- Spatula's serrated edge cuts ingredients
- Tongs are made of premium stainless steel and have a non-twisting joint for precision
- Tongs serration enables good grip
- Convenient loop for hanging when not in use
- Handle made of high-quality, heat-treated birch

FISKARS®

Norden
Pure Nordic

Grill chef cookware

Incorporate fresh, healthy outdoor cooking into your modern life. Norden Grill chef turns your outdoor grill into a complete kitchen, with versatile, stackable pieces that excel at cooking a wide variety of meals. You won't just prepare delicious food with Grill chef, you'll create adventures.

Pure Nordic cooking
fiskars.com



Plant Care



Pruners [p.26](#)

Loppers [p.41](#)

Hedge Shears [p.48](#)

Tree Pruners [p.51](#)

Scissors [p.54](#)



Why is Fiskars #1 in cutting?

Founded in 1649, Fiskars' iconic heritage of creating highly aesthetic, intuitive tools makes us proud to be a world-renowned expert in two-blade cutting and manual hand tools for gardening enthusiasts all over the world.

Design philosophy

We submerge ourselves in segmentation studies, immersive consumer interviews and usability research to find ingenious ways to continually improve our products. As a result, we've won many awards, including the prestigious RedDot Best of the Best Design Awards.

Innovation

We've developed hundreds of patents and technologies to-date, all designed to help our tools outperform the competition and feel like a natural extension of your body.

Durability & quality

In addition to using only the highest quality materials, all of our products must pass rigorous lab testing before they can be distributed.

Global leader

Already known as the world's #1 brand in scissors, our gardening tools are also top sellers in Europe, North America, Australia and the Middle East.

Commitment

If gardening is happiness, Fiskars is committed to providing tools to help you find 100% happiness in the garden.

Fiskars Pruners

Offer your customers a balance of products from each of our three ranges to ensure quality options for each and every consumer – no matter what motivates them.

X-series™

Exceptional performance.

Our top-of-the-line range of products combines the best of our technologies and ergonomics with the ultimate in durability, offering a best-in-class option that truly improves the perception – and experience – of the activity itself.

Model IDs: P900

Plus™

Adds something more.

Our mid-range offers the opportunity to trade-up casual users to reliable tools that are better equipped for rugged, everyday use. Improved durability and thoughtful, additional features allow these tools to offer a more enhanced user experience.

Model IDs: P500-700

Solid™

The solid choice.

Our base range offers quality, no-frills tools that will entice and introduce casual or new users to the brand.

Model IDs: P100-300



X-series™ Pruners

GUARANTEE
25
YEARS



reddot winner 2021
best of the best



Features & benefits

- 1 Best-in-class cutting performance**
Unique PowerGear™ mechanism generates 3x more cutting power. The rotating handle minimises strain on fingers, while allowing the user to use all their fingers simultaneously.
- 2 Blade capacity**
Designed for easy and clean cutting, these pruners are ideal for quick snips on thinner branches, as well as heavy cuts on thicker branches.
- 3 Blade coating**
Silver PTFE coating for less friction.
- 4 Grip**
Improved SoftGrip™ with texture for comfort and better grip.

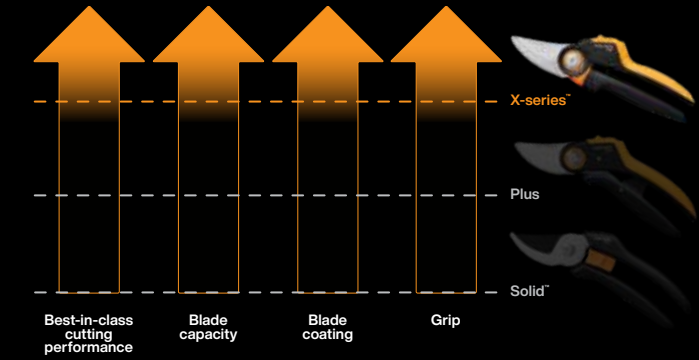
PowerGear™
3x
MORE
POWER



X-series™ Pruners

 
reddot winner 2021
best of the best

Exceptional performance.
Combining best-in-class technologies, ergonomics and durability to provide an experience that exceeds expectations. Gardening will never be the same.

X-series™ Bypass Pruner, L (P961)					Art.no. 1057175	EAN 
Height: 28,5cm	Length: 4,4cm	Width: 9,5cm	Weight: 0,25kg	Retail box: 4	Oldart.no. -	
				<ul style="list-style-type: none"> • PowerGear™ maximises leverage for 3x more power. • For clean cuts on green, living growth up to Ø 26 mm. • Fully hardened, precision-ground steel blade stays sharp longer. • Low-friction blade coating resists rust and improves performance, resulting in smoother cuts and less gumming. • Ergonomic FiberComp™ handle with full SoftGrip™ details for secure, comfortable grip. • Optimised for both medium and large hand sizes. 		
X-series™ Anvil Pruner (P941)					Art.no. 1057174	EAN 
Height: 28,5cm	Length: 4,4cm	Width: 9,5cm	Weight: 0,25kg	Retail box: 4	Oldart.no. -	
				<ul style="list-style-type: none"> • PowerGear™ maximises leverage for 3x more power. • Anvil-style blade for cleaner cuts while pruning dead growth up to Ø 26 mm. • Fully hardened, precision-ground steel blade stays sharp longer. • Low-friction blade coating resists rust and improves performance, resulting in smoother cuts and less gumming. • Ergonomic FiberComp™ handle with full SoftGrip™ details for secure, comfortable grip. 		
X-series™ Bypass Pruner, M (P921)					Art.no. 1057173	EAN 
Height: 28,5cm	Length: 4,4cm	Width: 9,5cm	Weight: 0,25kg	Retail box: 4	Oldart.no. -	
				<ul style="list-style-type: none"> • PowerGear™ maximises leverage for 3x more power. • Bypass blade for clean cuts on green, living growth up to Ø 24 mm. • Fully hardened, precision-ground steel blade stays sharp longer. • Low-friction blade coating resists rust and improves performance, resulting in smoother cuts and less gumming. • Ergonomic FiberComp™ handle with full SoftGrip™ details for secure, comfortable grip. • Optimised for both small and medium hand sizes. 		

Plus Pruners



Features & benefits

- 1 Best-in-class cutting performance**
Sharp and long-lasting, hardened carbon steel blades
- 2 Blade capacity**
Ideal for medium-sized branches
- 3 Blade coating**
PTFE coating for less friction
- 4 Grip**
SoftGrip™ for comfort and better grip

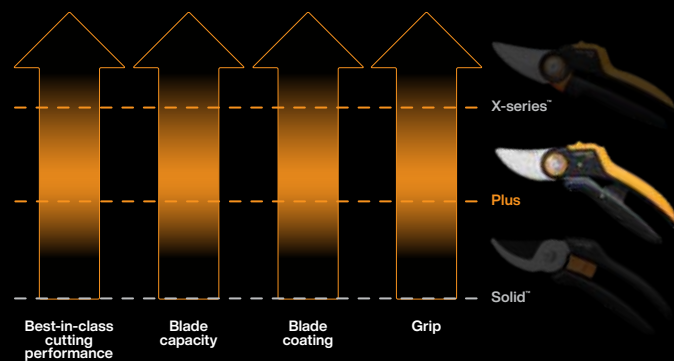

Plus Pruners



Adds something more.

Trusted performers with additional features that not only improve durability, but enhance the overall experience. Better tools, equipped for rugged, everyday use.

Plus™ Bypass Pruner, metal (P751)					Art.no. 1057172	EAN 6 411501 111197
Height: 28,5cm	Length: 2,5cm	Width: 9,5cm	Weight: 0,28kg	Retail box: 4	Oldart.no. -	



- Power-Lever™ powers through tough stems and branches.
- Bypass blade for clean cuts on green, living growth up to Ø 22 mm.
- Fully hardened, precision-ground steel blade stays sharp longer.
- Low-friction blade coating resists rust and improves performance, resulting in smoother cuts and less gumming.
- Ergonomic cast-aluminium handle with SoftGrip™ details for secure, comfortable grip.

Plus™ Anvil Pruner (P741)					Art.no. 1057171	EAN 6 411501 111180
Height: 28,5cm	Length: 2,5cm	Width: 9,5cm	Weight: 0,21kg	Retail box: 4	Oldart.no. -	



- Power-Lever™ powers through tough stems and branches.
- Anvil-style blade for cleaner cuts while pruning dead growth up to Ø 24 mm.
- Fully hardened, precision-ground steel blade stays sharp longer.
- Low-friction blade coating resists rust and improves performance, resulting in smoother cuts and less gumming.
- Ergonomic FiberComp™ handle with SoftGrip™ reduces fatigue and adds durability and comfort.

Plus™ Bypass Pruner (P721)					Art.no. 1057170	EAN 6 411501 111173
Height: 28,5cm	Length: 2,5cm	Width: 9,5cm	Weight: 0,20kg	Retail box: 4	Oldart.no. -	



- Power-Lever™ powers through tough stems and branches.
- Bypass blade for clean cuts on green, living growth up to Ø 24 mm.
- Fully hardened, precision-ground steel blade stays sharp longer.
- Low-friction blade coating resists rust and improves performance, resulting in smoother cuts and less gumming.
- Ergonomic FiberComp™ handle with full SoftGrip™ details for secure, comfortable grip.



reddot winner 2021
best of the best

Plus™ SmartFit™ Bypass Pruner (P541)					Art.no. 1057169	EAN 6 411501 111166
Height: 26,5cm	Length: 2cm	Width: 7,6cm	Weight: 0,19kg	Retailbox: 4	Oldart.no. -	



- SmartFit™ lever adjusts how wide the pruner opens for easy pruning of stems and branches.
- For clean cuts on green, living growth up to Ø 24 mm.
- Fully hardened, precision-ground steel blade stays sharp longer.
- Low-friction blade coating resists rust and improves performance, resulting in smoother cuts and less gumming.
- Ergonomic FiberComp™ handle with full SoftGrip™ detail for a secure, comfortable grip.
- Easy-open lock protects blade during transport and storage.

Plus™ Bypass Pruner, metal (P531)					Art.no. 1057168	EAN 6 411501 111159
Height: 27,1cm	Length: 2,3cm	Width: 7,6cm	Weight: 0,27kg	Retailbox: 4	Oldart.no. -	



- Fully hardened, precision-ground steel blade stays sharp longer.
- Bypass blade for clean cuts on green, living growth up to Ø 24 mm.
- Low-friction blade coating resists rust and improves performance, resulting in smoother cuts and less gumming.
- Ergonomic cast aluminium handle with full SoftGrip™ detail for a secure, comfortable grip.
- Conveniently placed lock for quick, easy activation.

Plus™ Bypass Pruner (P521)					Art.no. 1057167	EAN 6 411501 111142
Height: 26,5cm	Length: 2cm	Width: 7,6cm	Weight: 0,2kg	Retailbox: 4	Oldart.no. -	



- Fully hardened, precision-ground steel blade stays sharp longer.
- Bypass blade for clean cuts on green, living growth up to Ø 24 mm.
- Low-friction blade coating resists rust and improves performance, resulting in smoother cuts and less gumming.
- Ergonomic FiberComp™ handle with full SoftGrip™ detail for a secure, comfortable grip.
- Easy-open lock protects blade during transport and storage.

Anvil or bypass?



Both blade and counter blade press into the wood to make clean cuts with less compression damage. In other words, the cutting blade bypasses the counter blade in a scissors-like fashion. This makes it possible to cut close to the stem, making bypass pruners ideal for cutting fresh wood.



The upper blade is forced through the wood with greater pressure as the anvil blade supports the branch, spreading pressure until the cut is complete. Anvil blades are ideal for cutting dry or dead wood.

Solid™ Pruners

The “solid choice.”
Simple, effective and affordable with the quality Fiskars is known for. In short, these tools get the job done.



reddot winner 2021
best of the best



Features & benefits

- 1 Best-in-class cutting performance**
Hardened steel blades
- 2 Blade capacity**
Ideal for small branches
- 3 Blade coating**
PTFE coating for less friction
- 4 Grip**
Suitable for both left- & right-handed use with comfortable durable handles

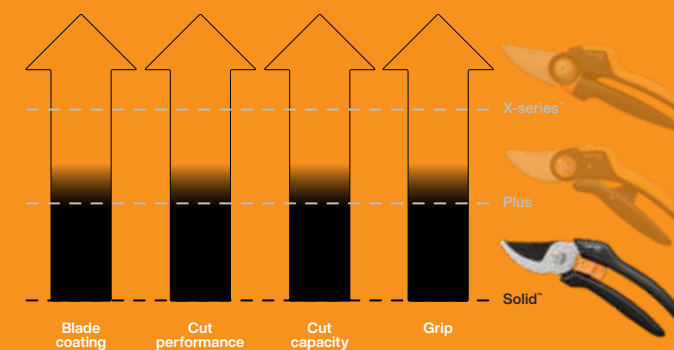

Solid™ Pruners



reddot winner 2021
best of the best

Solid™ Anvil Pruner (P361)					Art.no. 1057165	EAN 6 411501 111128
Height: 26,5cm	Length: 2cm	Width: 7,6cm	Weight: 0,19kg	Retailbox: 4	Oldart.no. -	



- Fully hardened, precision-ground steel blade stays sharp longer.
- Anvil-style blade for cleaner cuts while pruning dead growth up to Ø22 mm.
- Low-friction blade coating resists rust and improves performance, resulting in smoother cuts and less gumming.
- Light, yet sturdy, FiberComp™ handle has full SoftGrip™ detail for a secure, comfortable grip.
- Easy-open lock protects blade during transport and storage.

Solid™ Bypass Pruner (P341)					Art.no. 1057164	EAN 6 411501 111111
Height: 26,5cm	Length: 2cm	Width: 7,6cm	Weight: 0,19kg	Retailbox: 4	Oldart.no. -	



- Fully hardened, precision-ground steel blade stays sharp longer.
- Bypass blade for clean cuts on green, living growth up to Ø20 mm.
- Low-friction blade coating resists rust and improves performance, resulting in smoother cuts and less gumming.
- Light, yet sturdy, FiberComp™ handle has full SoftGrip™ detail for a secure, comfortable grip.
- Easy-open lock protects blade during transport and storage.

Solid™ Bypass Pruner, metal (P331)					Art.no. 1057163	EAN 6 411501 111098
Height: 25,8cm	Length: 2,3cm	Width: 7,6cm	Weight: 0,2kg	Retailbox: 4	Oldart.no. -	



- Fully hardened, precision-ground steel blade stays sharp longer.
- Bypass blade for clean cuts on green, living growth up to Ø20 mm.
- Low-friction blade coating resists rust and improves performance, resulting in smoother cuts and less gumming.
- Strong steel handle with SoftGrip™ for added comfort.
- Easy-open lock protects blade during transport and storage.

Solid™ Bypass Pruner (P321)					Art.no. 1057162	EAN 6 411501 111081
Height: 26cm	Length: 2cm	Width: 7,6cm	Weight: 0,18kg	Retailbox: 4	Oldart.no. -	



- Fully hardened, precision-ground steel blade stays sharp longer.
- Bypass blade for clean cuts on green, living growth up to Ø20 mm.
- Low-friction blade coating resists rust and improves performance, resulting in smoother cuts and less gumming.
- Light, yet sturdy, FiberComp™ handle with SoftGrip™ for added comfort.
- Easy-open lock protects blade during transport and storage.

Solid™ Bypass Pruner (P121)					Art.no. 1057160	EAN 6 411501 111029
Height: 25,5cm	Length: 2cm	Width: 7,6cm	Weight: 0,14kg	Retailbox: 4	Oldart.no. -	



- Fully hardened, precision-ground steel blade stays sharp longer.
- Bypass blade for clean cuts on green, living growth up to Ø18 mm.
- Low-friction blade coating resists rust and improves performance, resulting in smoother cuts and less gumming.
- Light, yet sturdy, FiberComp™ handle.
- Easy-open lock protects blade during transport and storage.

FISKARS

Prune trees & shrubs every spring to promote flowering, fruit development and renewal

Become an expert with Fiskars' Pruning Guide



fiskars.com/pruning-guide

Choose the right pruner



X-SERIES™

- PowerGear™ technology maximises leverage where you need it most, for 3x more cutting power
- Fully hardened, precision-ground steel blades stay sharp longer
- Low-friction blade coating resists rust and improves performance, resulting in smoother cuts and less gumming
- Ergonomically designed FiberComp™ handle fits the natural shape of your hand and has full SoftGrip™ details for a secure, comfortable grip
- 25-year guarantee



PLUS™

- Power-Lever™ technology powers through tough stems and branches
- SmartFit™ lever adjusts how wide the pruner opens for easier cuts
- Fully hardened, precision-ground steel blades stay sharp longer
- Ergonomically designed, FiberComp™ or cast-aluminium handle fits the natural shape of your hand and has full SoftGrip™ details for a secure, comfortable grip



SOLID™

- Ideal for easy cuts through stems and branches
- Fully hardened, precision-ground steel blade stays sharp longer
- Light, yet sturdy, FiberComp™ handle has full SoftGrip™ detail for a secure, comfortable grip
- Easy-open lock protects the blade during transport and storage



POWERSTEP™

- Allows for easy cuts through both thin and thick branches, using the same tool - without compromising on performance
- Thin branches are cut in one easy snip - thicker branches in 2 or 3 gradual steps to reduce the force needed per stroke
- Mechanism automatically sets the applicable amount of strokes



FINGERLOOP™

- Lightweight and strong FiberComp™ handles with SoftGrip™ for added comfort and safety
- Fingers are protected by the loop in the lower handle
- Corrosion-resistant, stainless steel blades



PRO PRUNERS

- Professional-quality CrMoV blades
- Easy to maintain, with all parts being replaceable
- Lightweight with SoftGrip™ and shock absorber
- Handles and lock accommodate both left- and right-handed users

Professional Pruners

These shears have been developed with professionals' needs in mind. Made of the best materials, all parts are replaceable for added convenience. The Pro Pruner features a traditional design and includes special features such as a wire cutter.

Pruning Shears, Medium (PB-8)

Height: 29 cm	Length: 2,5 cm	Width: 8,4 cm	Weight: 0,23 kg	Retail box: 4
---------------	----------------	---------------	-----------------	---------------

Art.no. 1020204

Old art.no. 111850



- Professional quality CrMoV blades.
- Bypass blade for clean cuts on green, living growth up to Ø 26 mm.
- Lightweight, durable, all-weather FiberComp™ handles with sturdy grip.
- Left/right hand lock.
- Greased cone bolt.
- Sap groove.

Pro Pruner (P90)

Height: 23 cm	Length: 2 cm	Width: 7 cm	Weight: 0,27 kg	Retail box: 4
---------------	--------------	-------------	-----------------	---------------

Art.no. 1001530

Old art.no. 111960



- Blades have side support to ensure they stay in place when cutting thick branches up to Ø 26 mm.
- Includes a wire cutter to spare the blades.
- Nut locking ring allows for adjustable tightening to help ensure consistent, precise cuts.

Fingerloop Pruners

Our fingerloop range includes two pruners and a snip for a neat, ergonomic way to prune branches and perform basic cutting tasks without excessive hand strain. The signature loop handle engages the power of all fingers while SoftGrip™ detail provides an extra level of comfort for extended work in the garden.

Fingerloop Pruner Bypass (P44)					Art.no. 1001534	EAN 6 411501 964403
Height: 26,5cm	Length: 3cm	Width: 9cm	Weight: 0,18kg	Retailbox: 4	Oldart.no. 111440	



- For cutting fresh wood up to Ø20 mm.
- Fingerloop protects fingers while keeping the pruner comfortably in hand.
- Non-stick coating on upper blades allows for easier cuts and cleaning.

Fingerloop Universal Snip (SP45)					Art.no. 1001533	EAN 6 411501 964502
Height: 26,5cm	Length: 3cm	Width: 9cm	Weight: 0,20kg	Retailbox: 4	Oldart.no. 111450	



- Designed to cut steel, plastic, tubes, rope or hoses up to Ø20 mm.
- Fingerloop protects fingers while keeping the pruner comfortably in hand.

NOTE! Not for cutting branches in garden.

Solid™ Snips

Solid™ Pruning Micro-Tip Snip (SP130)					Art.no. 1051600	EAN 6 411501 110817
Height: 21,5cm	Length: 2cm	Width: 8,4cm	Weight: 0,08kg	Retailbox: 4	Oldart.no. -	



- Ideal for encouraging healthy growth on plants and flowers.
- Precision blades for shaping, repetitive trimming and intricate snips in tight places.
- Stainless steel blades stay sharp – even through heavy use.
- SoftGrip™ touch-points on handle enhance comfort and control.
- Easy-open lock protects the blade during transport and storage.

Solid™ Pruning Floral Snip (SP141)					Art.no. 1051601	EAN 6 411501 110824
Height: 24cm	Length: 2,2cm	Width: 8cm	Weight: 0,13kg	Retailbox: 4	Oldart.no. -	



- Ideal for encouraging healthy growth and working with cut flowers.
- For cuts up to Ø13 mm.
- Coated, hardened blades, for easy durable use SoftGrip™ touch points add comfort and control
- Includes stem stripper and wire cutter.

Solid™ Pruning Snips (SP151)					Art.no. 1051602	EAN 6 411501 110831
Height: 21,5cm	Length: 2cm	Width: 8,4cm	Weight: 0,1kg	Retailbox: 4	Oldart.no. -	



- Ideal for intricate cuts on plants and flowers while trimming and shaping.
- Stainless steel blades stay sharp – even through heavy use.
- SoftGrip™ touch-points on handle enhance comfort and control.
- Extra-large handle loops leave plenty of room for gloves.
- Handle design suits both left and right-handed users.

Solid™ Herb Snip (SP220)					Art.no. 1063326	EAN 6 424002 014669
Height: 20,5cm	Length: 2,5cm	Width: 8,2cm	Weight: 0,07kg	Retailbox: 4	Oldart.no. -	



- Ideal for quickly chopping and mincing herbs and vegetables directly into the bowl.
- Stainless steel blades stay sharp longer.
- Forward hand position allows for quick cuts at any angle.
- Spring-action design opens after each cut to reduce hand strain.

Solid™ Multi Task Snips (SP320)					Art.no. 1063328	EAN 6 424002 014683
Height: 29,5cm	Length: 1,6cm	Width: 9cm	Weight: 0,11kg	Retailbox: 4	Oldart.no. -	



- Ideal for easily cutting netting, landscape fabric or slicing open soil bags.
- Sharp, stainless steel blades.
- Use outer serrated edge to saw rope, straight edge to open boxes and integrated wire cutter to cut wire.
- Spring-action design opens after each cut to reduce hand strain.
- Easy-open blade lock and sheath with belt loop for safe storage and portability.

Other Pruners

PowerStep™ Anvil Pruner (P83)

Height: 28,5cm | Length: 2,6cm | Width: 9,3cm | Weight: 0,15kg | Retailbox: 4

Art.no. 1000575

Oldart.no. 111670



- Ideal for cutting twigs and branches up to Ø24 mm with reduced effort.
- FiberComp™ handle and top SoftGrip™ handle for increased comfort.
- FiberComp™ anvil blade for increased durability.
- Thin branches are cut in one easy snip – thicker branches in 2 or 3 gradual steps to reduce the force needed per stroke.
- Mechanism automatically sets the applicable amount of strokes.

Bypass Pruner, white (P57)

Height: 24cm | Length: 2,5cm | Width: 9,2cm | Weight: 0,14kg | Retailbox: 4

Art.no. 1026916

Oldart.no. -



- Ideal for easy cuts on twigs and branches up to Ø20 mm.
- White colour for improved visibility.
- Ultra lightweight operation due to FiberComp™ construction.
- Power-Lever™ technology allows for added cutting power.
- Ambidextrous locking mechanism.

Choose the right lopper

Suitable for all kinds of garden cutting tasks with a capacity of up to Ø 55 mm, Fiskars loppers are designed to be lightweight, efficient and comfortable to use.



Different heads for different purposes

- 1 **Bypass head**
For frequent cuts on fresh wood
- 2 **Anvil head**
For cutting dry and/or hard/dead wood
- 3 **Hook head**
For heavy cuts on fresh wood
- 4 **Scissor head**
For precision cuts

PowerGear™ X Loppers



PowerGear™ X Bypass Lopper, L (LX98)					Art.no. 1020188	EAN
Height: 85cm	Length: 3cm	Width: 25,5cm	Weight: 1,34kg	Retailbox: 4	Oldart.no. 112490	



- For heavy cuts on fresh wood up to Ø 50 mm.
- Bypass blades easily catch branches while providing clean cuts.
- Durable and light aluminium shaft with comfortable SoftGrip™ handles.

PowerGear™ X Anvil Lopper, L (LX99)					Art.no. 1020189	EAN
Height: 85cm	Length: 3cm	Width: 25,5cm	Weight: 1,36kg	Retailbox: 4	Oldart.no. 112440	



- For heavy cuts of hard and dry wood up to Ø 55 mm.
- Anvil blade configuration for added durability and efficiency.
- Durable, light aluminium shaft with comfortable SoftGrip™ handles.

PowerGear™ X Bypass Lopper, M (LX94)					Art.no. 1020187	EAN
Height: 69cm	Length: 3cm	Width: 20,3cm	Weight: 1,19kg	Retailbox: 4	Oldart.no. 112390	



- For frequent cuts on fresh wood up to Ø 50 mm.
- Bypass blades easily catch branches while providing clean cuts.
- Durable and light aluminium shaft with comfortable SoftGrip™ handles.

PowerGear™ X Bypass Lopper, S (LX92)					Art.no. 1020186	EAN
Height: 62cm	Length: 2,5cm	Width: 23cm	Weight: 0,83kg	Retailbox: 4	Oldart.no. 112260	



- For frequent cuts on fresh wood up to Ø 38 mm.
- Bypass blades easily catch branches while providing clean cuts.
- Durable and light aluminium shaft with comfortable SoftGrip™ handles.

PowerGear™ Loppers

PowerGear™ Hook Head Bypass Lopper, L (L78)					Art.no. 1000584	EAN
Height: 75cm	Length: 3,4cm	Width: 22,5cm	Weight: 0,94kg	Retailbox: 4	Oldart.no. 112590	



- For heavy cutting of fresh wood up to Ø 50 mm.
- Very light weight due to FiberComp™ construction.
- Bypass blades for easy catching of branches and a clean cuts.

PowerGear™ Anvil Lopper, L (L77)					Art.no. 1000583	EAN
Height: 74,5cm	Length: 3,5cm	Width: 24,5cm	Weight: 1,12kg	Retailbox: 4	Oldart.no. 112580	



- For heavy cutting of hard and dry wood up to Ø 50 mm.
- Very light weight due to FiberComp™ construction.
- Anvil blade configuration for added durability and effective cuts.

PowerGear™ Scissor Head Bypass Lopper, M (L76)					Art.no. 1001553	EAN
Height: 61,3cm	Length: 3cm	Width: 18,4cm	Weight: 0,59kg	Retailbox: 4	Oldart.no. 112300	



- For cutting of fresh wood up to Ø 40 mm.
- Very light weight due to FiberComp™ construction.
- Scissor head blades optimised for precision cutting.

PowerGear™ Hook Head Bypass Lopper, M (L74)					Art.no. 1000582	EAN
Height: 60,7cm	Length: 3cm	Width: 18,3cm	Weight: 0,50kg	Retailbox: 4	Oldart.no. 112290	



- For cutting of fresh wood up to Ø 38 mm.
- Very light weight due to FiberComp™ construction.
- Bypass blades for easy catching of branches and a clean cuts.

PowerGear™ Scissors Head Bypass Lopper, S (L72)					Art.no. 1001555	EAN
Height: 51cm	Length: 2,5cm	Width: 15,7cm	Weight: 0,27kg	Retailbox: 4	Oldart.no. 112200	



- For frequent cutting of fresh wood up to Ø 30 mm.
- Very light weight due to FiberComp™ construction.
- Scissor head blades optimised for precision cutting.

PowerGear™ Anvil Lopper, S (L71)					Art.no. 1001556	EAN 6 411501 121806
Height: 51cm	Length: 3cm	Width: 17cm	Weight: 0,52kg	Retailbox: 4	Oldart.no. 112180	



- For cutting of hard, dry wood up to Ø 40 mm.
- Very light weight due to FiberComp™ construction.

PowerGear™ Hook Head Bypass Lopper, S (L70)					Art.no. 1002104	EAN 6 411501 121905
Height: 50,5cm	Length: 2,4cm	Width: 15,4cm	Weight: 0,43kg	Retailbox: 4	Oldart.no. 112190	



- For frequent cutting of fresh wood up to Ø 38 mm.
- Very light weight due to FiberComp™ construction.
- Hooked bypass blades for easy catching of branches and a clean cuts.

PowerGear™ Anvil Lopper, S (L31)					Art.no. 1000581	EAN 6 411503 961707
Height: 43,2cm	Length: 2,4cm	Width: 18cm	Weight: 0,40kg	Retailbox: 4	Oldart.no. 112170	



- For cutting of hard, dry wood up to Ø 35 mm.
- Very light weight due to FiberComp™ construction.

SmartFit™ Lopper

SmartFit™ Bypass Lopper (L86)					Art.no. 1013564	EAN 6 411501 125002
Height: 70,6cm	Length: 4,2cm	Width: 24,9cm	Weight: 1,28kg	Retailbox: 4	Oldart.no. 112500	



- For cutting branches up to Ø 50 mm both far and near.
- Adjustable shaft length between 66,5 - 91,5 cm for optimal working position.
- Hooked bypass blades easily catch branches while providing clean cuts.
- SoftGrip™ covered handles for increased comfort.

SingleStep™ Loppers

SingleStep™ Hook Head Bypass Lopper, L (L38)					Art.no. 1001426	EAN 6 411501 124609
Height: 88,6cm	Length: 2,5cm	Width: 34,6cm	Weight: 1,16kg	Retailbox: 4	Oldart.no. 112460	



- For heavy cutting of fresh wood.
- Cut capacity: Ø 40 mm.
- Hardened steel blades with non-stick coating.

SingleStep™ Hook Head Anvil Lopper, L (L39)					Art.no. 1001430	EAN 6 411501 124500
Height: 88,6cm	Length: 2,5cm	Width: 34,6cm	Weight: 1,20kg	Retailbox: 4	Oldart.no. 112450	



- For heavy cutting of dry and hard wood.
- Cut capacity: Ø 40 mm.
- Upper blade features hardened steel with non-stick coating; aluminium anvil blade.

SingleStep™ Hook Head Bypass Lopper, S (L28)					Art.no. 1001432	EAN 6 411501 121608
Height: 57cm	Length: 2,5cm	Width: 17,5cm	Weight: 0,96kg	Retailbox: 4	Oldart.no. 112160	



- For cutting fresh wood.
- Cut capacity: Ø 35 mm.
- Hardened steel blades with non-stick coating.

Other Loppers

Lopper, white (L32)					Art.no. 1026930	 EAN 6 411501 150196
Height: 43,2cm	Length: 2,4cm	Width: 18cm	Weight: 0,37kg	Retailbox: 4	Oldart.no. -	



- For cuts on hard, dry wood up to Ø35 mm.
- White colour for added visibility.
- Lightweight FiberComp® construction.

Anvil or bypass?



Both blade and counter blade press into the wood to make clean cuts with less compression damage. In other words, the cutting blade bypasses the counter blade in a scissors-like fashion. This makes it possible to cut close to the stem, making bypass pruners ideal for cutting fresh wood.



The upper blade is forced through the wood with greater pressure as the anvil blade supports the branch, spreading pressure until the cut is complete. Anvil blades are ideal for cutting dry or dead wood.

FISKARS



Spring is the best time to prune and trim your garden's shrubs, hedges & trees

Become an expert with Fiskars' Pruning Guide



fiskars.com/pruning-guide

Hedge Shears

Whether you're interested in topiary, controlling annual growth or keeping a nice straight line in your hedge, Fiskars has a full range of hedge shears for your needs. From robust SingleStep™ action hedge shears to adjustable telescopic shears, to shears featuring our unique PowerGear™ technology, for 3x more cutting power, right to the tip.



POWERGEAR™ X
Ultra durable with PowerGear™ technology for up to 3x more power



POWERLEVER™
Lightweight with up to 2x more cutting power



SMARTFIT™
Adjustable shaft length for optimal working position



SINGLESTEP™
Sturdy and comfortable

PowerGear™ Hedge Shears

PowerGear™ X Hedge Shears (HSX92)					Art.no. 1023631	EAN 6 411501 140067
Height: 66,5 cm	Length: 7,5 cm	Width: 16,5 cm	Weight: 1,10 kg	Retail box: 4	Old art.no. -	



- For effortless trimming of hedges and bushes.
- Unique PowerGear™ mechanism makes cutting up to 3 times easier vs standard mechanisms.
- Lightweight and durable with PTFE-coated, precision-ground blades.
- SoftGrip™ handles for optimum comfort and balance.

PowerGear™ Hedge Shears (HS72)					Art.no. 1000596	EAN 6 411501 147905
Height: 61,2 cm	Length: 4,5 cm	Width: 17 cm	Weight: 0,72 kg	Retail box: 4	Old art.no. 114790	



- For easy trimming of hedges and bushes.
- PowerGear™ technology reduces effort with up to 3x more cutting power.
- Lightweight, FiberComp™ shaft.

SmartFit™ Hedge Shears

SmartFit™ Hedge Shears (HS86)					Art.no. 1013565	EAN 6 411501 148001
Height: 73,5 cm	Length: 7,6 cm	Width: 21,5 cm	Weight: 1,25 kg	Retail box: 4	Old art.no. 114800	



- For trimming of hedges and bushes both far and near.
- Adjustable shaft length 68 - 93 cm for optimal working position.
- Comfortable, non-slip SoftGrip™ handles.

PowerLever™ Hedge Shears

PowerLever™ Hedge Shears (HS52)					Art.no. 1001564	EAN 6 411501 967503
Height: 58,8cm	Length: 7,2cm	Width: 14,8cm	Weight: 0,61kg	Retail box: 4	Oldart.no. 114750	



- For easy trimming of hedges and bushes.
- PowerLever™ technology reduces effort with up to 2x more cutting power.
- Lightweight, FiberComp™ shaft.

Other Hedge Shears

SingleStep™ Hedge Shears Wavy Blade (HS22)					Art.no. 1001433	EAN 6 411501 147301
Height: 58cm	Length: 13cm	Width: 19cm	Weight: 0,71kg	Retail box: 4	Oldart.no. 114730	



- For trimming hedges and bushes.
- Sturdy, comfortable, glassfibre-reinforced polypropene (PPGF) handle.
- Hardened steel blades with non-stick coating.

Hedge Shears, white (HS53)					Art.no. 1026931	EAN 6 411501 150202
Height: 58,8cm	Length: 7,2cm	Width: 14,8cm	Weight: 0,61kg	Retail box: 4	Oldart.no. -	



- For easy trimming of hedges and bushes.
- White colour that makes the hedge shears more visible.
- PowerLever™ technology reduces effort with up to 2x more cutting power.
- Lightweight, FiberComp™ shaft.

Solid™ Hedge Shears (HS21)					Art.no. 1026827	EAN 6 411501 150271
Height: 59cm	Length: 4,5cm	Width: 15cm	Weight: 0,32kg	Retail box: 4	Oldart.no. -	



- For trimming hedges and bushes.
- Hardened steel blades.
- Sturdy, comfortable handles with Softouch™ grip.

PowerGear™ X Tree Pruners

More power with less effort

Improved strength of cutting head

Better maintenance

Spare parts available

Easy cutting in all directions

Adjustable head turns 230°

Telescopic Tree Pruner

↑ **6 m** reach

Tree Pruner

↑ **3,5 m** reach

Adjustable head turns 230°

Improved strength and maintenance of cutting head

SoftGrip™ for better grip

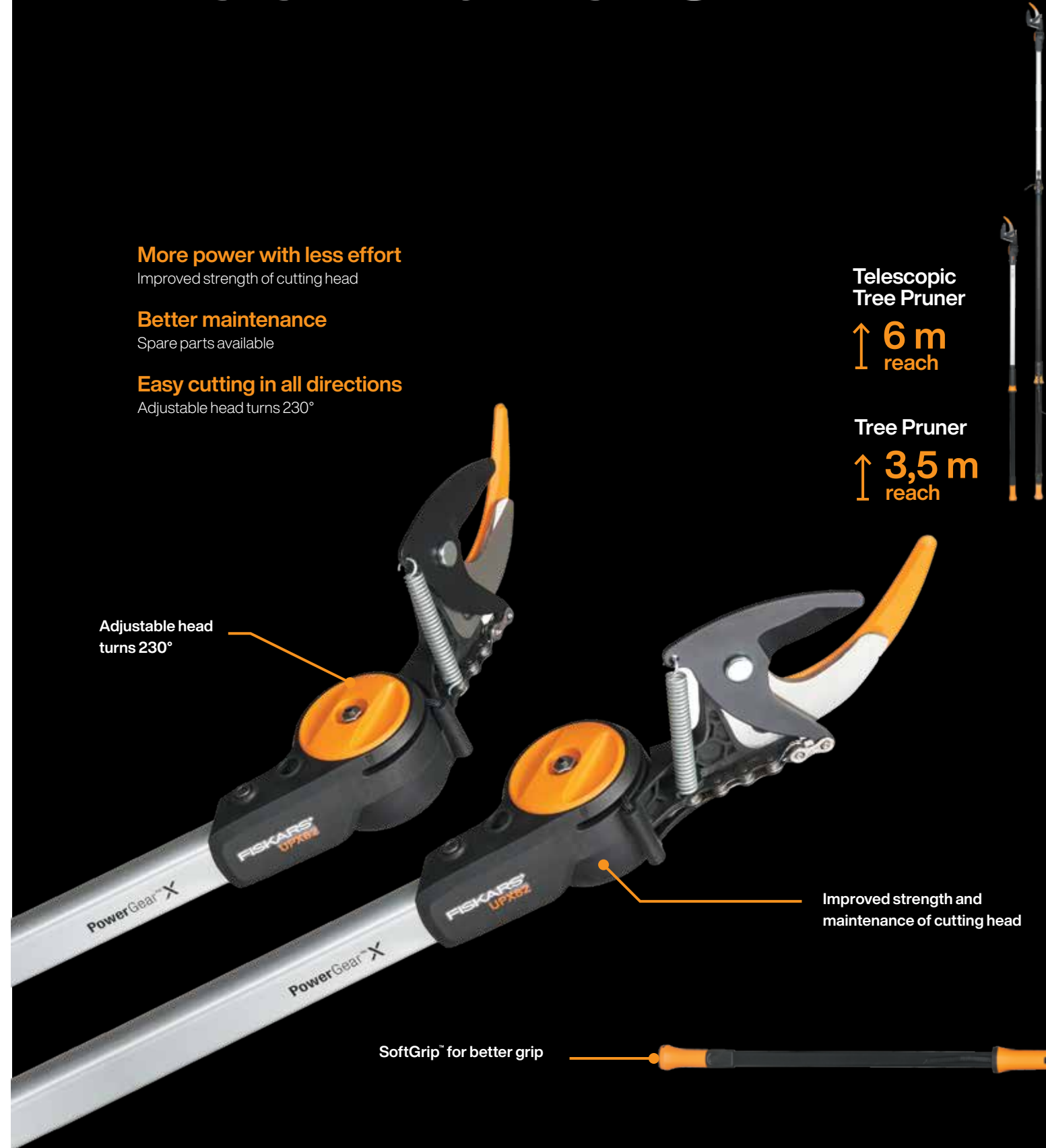

PowerGear™ X Tree Pruners

Fiskars tree pruners are multi-use tools that allow access to tree crowns and dense bushes, allowing gardeners to trim high branches without the use of a ladder - or at ground level without bending or kneeling.

PowerGear™ X Telescopic Tree Pruner (UPX86)					Art.no. 1023624	EAN 6 411501 150127
Height: 230,3cm	Length: 7,4cm	Width: 11,2cm	Weight: 1,90kg	Retail box: 2	Old art.no. -	



- Extended reach for cutting fresh wood up to Ø 32 mm.
- Shaft length adjustable from 2,4 - 4 meters, maximum reach 6 meters.
- Adjustable cutting head, up to 230°.
- Orange cutting support for added visibility.
- Durable, SoftGrip™ handle with non-slip base.



PowerGear™ X Tree Pruner (UPX82)					Art.no. 1023625	EAN 6 411501 150134
Height: 165cm	Length: 7cm	Width: 11,5cm	Weight: 1,14kg	Retail box: 4	Old art.no. -	



- Extended reach for cutting fresh wood up to Ø 32 mm.
- Cutting reach approx 3,5 meters.
- Adjustable cutting head, up to 230°.
- Orange cutting support for added visibility.
- Durable SoftGrip™ handle and non-slip base.



Branch Saw for Tree Pruners UPX86, UPX82					Art.no. 1023633	EAN 6 411501 150165
Height: 47cm	Length: 7cm	Width: 8cm	Weight: 0,20kg	Retail box: 4	Old art.no. -	



- For sawing up to Ø 80 mm branches.
- Impulse hardened, quality steel blade.
- Hollow-grind blade for easier sawing.
- Adjustable sawing angle.
- Sturdy fastening mechanism to shaft, fits UPX82 & UPX86.

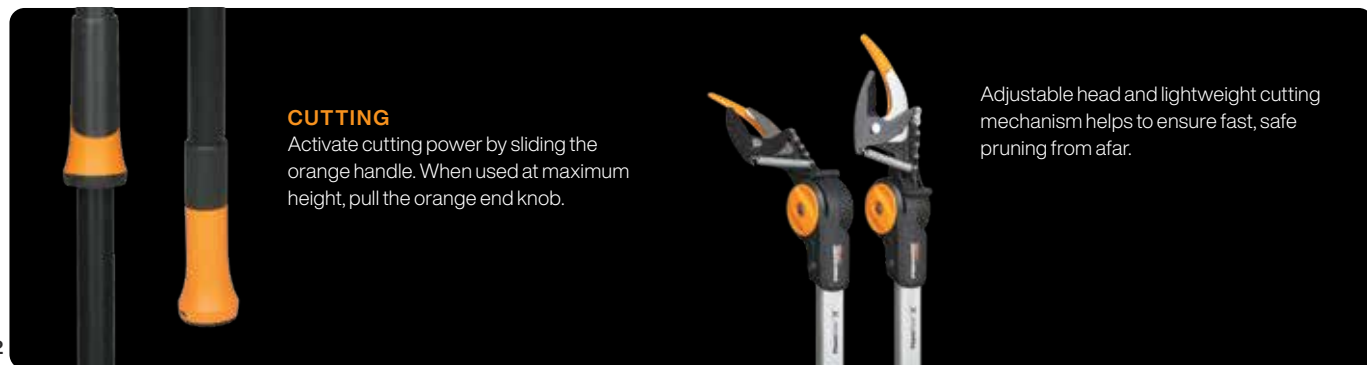

CUTTING

Activate cutting power by sliding the orange handle. When used at maximum height, pull the orange end knob.

Adjustable head and lightweight cutting mechanism helps to ensure fast, safe pruning from afar.

Other Tree Pruners & Accessories

Reach snip, black (UP69)					Art.no. 1073082	EAN 6 411501 600875
Height: 175,5cm	Length: 7,1cm	Width: 11,2cm	Weight: 0,9kg	Retail box: 4	Old art.no. 1023626	



- For trimming branches high and low, Ø 12 mm.
- Cutting reach approx 3,5 m.
- Adjustable handle 270° for easy handling.

Long Bypass Tree Pruner (UP84)					Art.no. 1001557	EAN 6 411501 963901
Height: 221cm	Length: 7,4cm	Width: 11,3cm	Weight: 1,26kg	Retail box: 2	Old art.no. 115390	



- Bypass cutting action for up to Ø 32 mm thick branches.
- Cutting reach of approximately 4,5 meters.
- Adjustable cutting angle up to 230°.
- Can be used with extension pole (art No 1001560) and fruit picker (art No 1001562).



Anvil Tree Pruner (UP53)					Art.no. 1000597	EAN 6 411501 963505
Height: 165cm	Length: 7,4cm	Width: 13,8cm	Weight: 0,85kg	Retail box: 4	Old art.no. 115350	



- Anvil cutting action is especially ideal for dry and hard wood up to Ø 32 mm.
- Cutting reach vertically about 3,5 meters.
- Adjustable cutting angle up to 260°.
- Can be used with fruit picker (art No 1001562).

Extension Pole (UP80), plus part					Art.no. 1001560	EAN 6 411502 964631
Height: 150,3cm	Length: 5,6cm	Width: 11cm	Weight: 0,53kg	Retail box: 4	Old art.no. 110460	



- Can be used with Bypass Tree Pruner (UP84) (art No 1001557).
- Can extend cutting heights with 1,5 meters.

Fruit Picker (UP80), plus part					Art.no. 1001562	EAN 6 411501 969705
Height: 33,4cm	Length: 7,5cm	Width: 16cm	Weight: 0,25kg	Retail box: 4	Old art.no. 110970	



- NEW Product design updated in 2022.
- Can be used with article No 1001557, 1000598, 1023624 and 1023625.
- FiberComp™ frame and tabs gently pull fruit from tree.
- Machine-washable, mesh bag catches the harvest, allowing you to see your yield.

The icon



The iconic Classic scissors are a symbol of Fiskars and our Finnish design heritage



Features & benefits

1 Sharp blades

Specially developed blade grind ensures blades stay sharp longer while providing high-precision cuts.

2 Easy cleaning

Handles are injection-molded onto the blades, ensuring easy, hygienic cleaning.

3 Supreme ergonomics

Handles are designed with strong consideration of the natural movement of the hand, resulting in enhanced comfort and cutting control.

4 Best materials

Made of the best quality materials, Classic scissors offer outstanding comfort, performance and durability.

5 Quality control

Each product is manually tested before leaving the factory, ensuring you get only the best scissors.

Tested by hand
Made in Finland

Classic Scissors

Universal Purpose Scissors, L, 25 cm (S94)					Art.no. 1001538	EAN 6 411501 110503
Height: 31cm	Length: 2,2cm	Width: 11cm	Weight: 0,16kg	Retail box: 5	Old art.no. 111050	
					<ul style="list-style-type: none"> • One billion scissors sold. • Ideal for all kinds of cutting tasks in the garden and at home. • Superior comfort and performance. • Long stainless steel blades. HRC 57. • Handles made from impact-resistant PBT. • Adjustable blade tension. • Made in Finland with premium and durable materials, tested by hand. • For right-handed. 	
Universal Purpose Scissors, 21 cm (S90)					Art.no. 1001539	EAN 6 411501 110404
Height: 28cm	Length: 2cm	Width: 8,6cm	Weight: 0,09kg	Retail box: 5	Old art.no. 111040A	
					<ul style="list-style-type: none"> • One billion scissors sold. • Ideal for all kinds of cutting tasks in the garden and at home. • Superior comfort and performance. • Large handles made from impact-resistant PBT. • Adjustable blade tension. • Made in Finland with premium and durable materials, tested by hand. • For right-handed. 	
Garden Scissors, 18 cm (S92)					Art.no. 1000555	EAN 6 411501 110305
Height: 28cm	Length: 2,1cm	Width: 8,6cm	Weight: 0,07kg	Retail box: 5	Old art.no. 111030	
					<ul style="list-style-type: none"> • One billion scissors sold. • Serrated blades ensure good grip and are ideal for cutting flowers and herbs. • Superior comfort and performance. • Handles made from impact-resistant PBT. • Adjustable blade tension. • Made in Finland with premium and durable materials, tested by hand. • For right-handed. 	

ReNew scissors

Recycled materials

These Fiskars scissors are skillfully crafted from recycled and renewable materials at our factory in Billnäs, Finland. The scissors handles are made from an innovative biocomposite material consisting of 66% recycled post-consumer plastic and 34% renewable cellulose fiber, a sustainable alternative to fossil-based materials. The blades themselves are also made of recycled stainless steel.

In addition to being made of recycled and renewable materials, these scissors, like all Fiskars products, are designed to be of highest quality and to offer long-lasting performance.



ReNew

– a conscious choice for all cutting needs in creating, cooking and gardening



Features & benefits

1 Made of recycled and renewable materials

Total scissors are made of 80% recycled materials and 13% renewable materials. Scissors are 100% recyclable. Scissors packaging is made of 100% recycled and recyclable paper fiber.

2 Sharp blades

Durable stainless steel blades are made of 85-95% recycled stainless steel.

3 Ergonomic design

Comfortable handles are made of 66% recycled plastic (post consumer package waste) and 34% natural cellulose fiber.

4 Made in Finland





















These scissors are made using an eco-friendly process in our environment-, quality- and safety -certified scissors factory in Billnäs, Finland.

5 Tested by hand

Scissors are tested by hand at the factory. Only our very best scissors are ever cleared to leave the factory.

Tested by hand
Made in Finland

ReNew Scissors

ReNew Universal scissors 21 cm					Art.no. 1058094	EAN 
Height: 27,5cm	Length: 1,5cm	Width: 8,5cm	Weight: 0,09kg	Retail box: 5	Oldart.no. -	
						<ul style="list-style-type: none"> • Made of recycled (80%) and renewable (13%) materials for unique comfort and cutting performance. • Universal scissors are ideal for a wide variety of uses in and around the home. • Durable, recycled (85-95%) stainless steel blades are precision ground for long-lasting sharpness. • Ergonomically designed handles are made of recycled plastic (66%) and renewable cellulose fibre (34%). • Made sustainably in Finland and tested by hand. • For right-handed.
ReNew Universal scissors large 25 cm					Art.no. 1062542	EAN 
Height: 32cm	Length: 2,5cm	Width: 9cm	Weight: 0,14kg	Retail box: 6	Oldart.no. -	
						<ul style="list-style-type: none"> • Made of recycled (80%) and renewable (13%) materials for unique comfort and cutting performance. • Large universal scissors are ideal for a wide variety of uses in and around the home. • Long, durable, recycled (85-95%) stainless steel blades are precision ground for long-lasting sharpness. • Large, ergonomically designed handles are made of recycled plastic (66%) and renewable cellulose fibre (34%). • Made sustainably in Finland and tested by hand. • For right-handed.
ReNew Garden scissors 21 cm					Art.no. 1062544	EAN 
Height: 27,5cm	Length: 1,5cm	Width: 8,5cm	Weight: 0,09kg	Retail box: 6	Oldart.no. -	
						<ul style="list-style-type: none"> • Made of recycled (80%) and renewable (13%) materials for unique comfort and cutting performance. • Serrated blades grip stems for clean, healthy cuts on flowers and herbs. • Durable, recycled (85-95%) stainless steel blades offer long-lasting sharpness. • Ergonomically designed handles are made of recycled plastic (66%) and renewable cellulose fibre (34%). • Made sustainably in Finland and tested by hand. • For right-handed.
ReNew Universal scissors small 17 cm					Art.no. 1062545	EAN 
Height: 22,5cm	Length: 1,5cm	Width: 8,5cm	Weight: 0,05kg	Retail box: 10	Oldart.no. -	
						<ul style="list-style-type: none"> • Made of recycled (80%) and renewable (13%) materials for unique comfort and cutting performance. • Small universal scissors are ideal for a wide variety of day-to-day uses in and around the home. • Durable, recycled (85-95%) stainless steel blades are precision-ground for long-lasting sharpness. • Ergonomically designed handles are made of recycled plastic (66%) and renewable cellulose fibre (34%). • Made sustainably in Finland and tested by hand. • For right-handed.
ReNew Hobby scissors 13 cm					Art.no. 1062546	EAN 
Height: 20,4cm	Length: 1,3cm	Width: 8,5cm	Weight: 0,02kg	Retail box: 10	Oldart.no. -	
						<ul style="list-style-type: none"> • Made of recycled (80%) and renewable (13%) materials for unique comfort and cutting performance. • Hobby scissors feature a safe blade edge for children, and can be safely stored in pockets and around the home. • Recycled (85-95%) stainless steel blades feature a blunt-tip for added safety. • Ergonomically designed handles are made of recycled plastic (66%) and renewable cellulose fibre (34%). • Made sustainably in Finland and tested by hand. • For right-and left-handed.

Lawn Care



Rakes [p.62](#)

Grass Shears [p.68](#)

Weed Pullers [p.72](#)

Stay Sharp [p.76](#)

Rakes

Fiskars rakes are designed for comfortable raking, cleaning and gathering. Our four ranges offer a wide selection of rakes including leaf and soil rakes.



XACT™

Premium quality materials and ergonomic, aluminium shafts for ultimate performance

ERGONOMIC™

Special teardrop-shaped shaft with wide head for effective raking

WHITE

Beautiful, white rakes are the perfect addition to your garden

SOLID™

A versatile selection of rakes ranging from lawn to soil care

Xact™ Rakes

Xact™ Leaf Rake, XXL, 620mm

Height: 176,5 cm Length: 4,6 cm Width: 62 cm Weight: 0,02 kg Retail box: 4

Art.no. 1027036



- Extremely durable leaf rake tines and XXL size are perfectly designed for efficient leaf gathering in XL areas.
- Hardened aluminium shaft with unique profile reduces weight without sacrificing strength for effortless strokes.
- SoftGrip™ handle allows for multiple hand positions, while exceptional handle end shape provides good support during use.
- Convenient hang hole for easy storage.

Xact™ Lawn Rake, L, 490mm

Height: 176 cm Length: 4,4 cm Width: 49 cm Weight: 0,80 kg Retail box: 4

Art.no. 1027037



- Large head with supremely functional tines are perfectly designed for easily gathering lawn clippings and debris from large areas.
- Hardened aluminium shaft with unique profile reduces weight without sacrificing strength for effortless strokes.
- SoftGrip™ handle allows for multiple hand positions, while exceptional handle end shape provides good support during use.
- Convenient hang hole for easy storage.

Xact™ Rose Rake, S, 230mm

Height: 165,5 cm Length: 7,1 cm Width: 23,5 cm Weight: 0,79 kg Retail box: 4

Art.no. 1027038



- Durable, stainless steel head with 10 prongs makes it ideal for raking in narrow areas.
- Efficient for cleaning and spreading soil in small spaces around, between and under plants.
- Hardened aluminium shaft with unique profile reduces weight without sacrificing strength for effortless strokes.
- SoftGrip™ handle allows for multiple hand positions, while exceptional handle end shape provides good support during use.
- Convenient hang hole for easy storage.

Xact™ Soil Rake, M, 370mm

Height: 164 cm Length: 8,5 cm Width: 37,3 cm Weight: 1,04 kg Retail box: 4

Art.no. 1027039



- Durable, stainless steel head with 13 prongs for raking in larger areas.
- Ideal for preparing planting beds, leveling soil, cleaning and spreading.
- Hardened aluminium shaft with unique profile reduces weight without sacrificing strength for effortless strokes.
- SoftGrip™ handle allows for multiple hand positions, while exceptional handle end shape provides good support during use.
- Convenient hang hole for easy storage.

Ergonomic™ Rakes

Ergonomic™ Lawn/Leaf Rake					Art.no. 1000660	EAN 5 905561 335705
Height: 184 cm	Length: 4,5 cm	Width: 61 cm	Weight: 0,77 kg	Retail box: 4	Old art.no. 135570	



- Wide rake for working on large lawn areas.
- Sturdy, flexible tines with specific geometry helps prevent twigs and leaves from getting caught.

Classic Rakes

Classic Leaf Rake, XL					Art.no. 1001584	EAN 3 157331 355914
Height: 173,5 cm	Length: 4,2 cm	Width: 64,6 cm	Weight: 0,90 kg	Retail box: 5	Old art.no. 135591	



- Extra wide head (65 cm) and wooden shaft.
- Flat, rigid and curved plastic tines reduce leaves from sliding up and blocking the head.
- Rounded edges make it suitable for all types of terrain.

Classic Leaf Rake					Art.no. 1003708	EAN 6 411501 358202
Height: 198 cm	Length: 9 cm	Width: 47 cm	Weight: 1,33 kg	Retail box: 4	Old art.no. 135820	



- For all raking tasks in the garden, including raking leaves to removing grass cuttings from the lawn.
- FSC® certified wood.

Classic Soil Rake					Art.no. 1003705	EAN 6 411501 357601
Height: 168 cm	Length: 6,5 cm	Width: 36 cm	Weight: 1,03 kg	Retail box: 4	Old art.no. 135760	



- Optimal for loosening up soil in planting beds and other general gardening tasks like raking branches or spreading mulch.
- FSC® certified wood.

White Rakes

Leaf Rake, white					Art.no. 1019606	EAN 6 411501 355638
Height: 172 cm	Length: 5,2 cm	Width: 52 cm	Weight: 0,55 kg	Retail box: 4	Old art.no. 135563	



- Light leaf and lawn rake for cleaning the lawn and yard.
- Sturdy and flexible tines help prevent twigs and leaves from getting caught.

Soil Rake, white					Art.no. 1019608	EAN 6 411501 355232
Height: 158 cm	Length: 6,5 cm	Width: 36 cm	Weight: 0,64 kg	Retail box: 4	Old art.no. 135523	



- Light soil rake for preparing planting beds, leveling soil, cleaning and spreading.
- Durable hardened head with 14 prongs for raking in larger areas.

Rose Rake, white					Art.no. 1019607	EAN 6 411501 355034
Height: 158 cm	Length: 6,5 cm	Width: 24,5 cm	Weight: 0,52 kg	Retail box: 4	Old art.no. 135503	



- Light rose rake for cleaning and spreading soil in small spaces around trees and under plants.
- Hardened steel form for raking between and under plants.

KEY BENEFITS

- ✓ Hole for easy storage
- ✓ SoftGrip™ handle for optimal grip
- ✓ Round-shaped, lightweight aluminium shaft
- ✓ Plastic sleeve maximises the grip while insulating from cold

Solid™ Rakes

Solid™ Leaf Rake, XL					Art.no. 1015645	EAN 6 4 1 1 5 0 1 3 5 0 9 0 9
Height: 176 cm	Length: 4,2 cm	Width: 62 cm	Weight: 0,83 kg	Retail box: 5	Oldart.no. 135090	



- Extra-wide head (62 cm) makes it easy to quickly rake large areas.
- Durable, aluminium lightweight shaft.
- 27 flat, rigid and curved plastic tines prevent leaves from sliding up and blocking the head.

Solid™ Leaf Rake, L assembled					Art.no. 1003465	EAN 6 4 1 1 5 0 1 3 5 0 1 6 9
Height: 175 cm	Length: 5 cm	Width: 52 cm	Weight: 0,50 kg	Retail box: 5	Oldart.no. 135016	



- Wide rake for working on large lawn areas.
- Sturdy and flexible tines with specific geometry help prevent twigs and leaves from getting caught.
- Lightweight, yet durable aluminium shaft.

Solid™ Leaf Rake, M assembled					Art.no. 1063090	EAN 6 4 1 1 5 0 1 7 0 4 3 5 1
Height: 172 cm	Length: 3,5 cm	Width: 44 cm	Weight: 0,52 kg	Retail box: 5	Oldart.no. -	



- Medium-sized all-purpose rake for working in smaller areas like around trees or under bushes.
- Sturdy tines work well on rooty and uneven surfaces.
- Lightweight but durable aluminium shaft.

Solid™ Universal Garden Rake					Art.no. 1003466	EAN 6 4 1 1 5 0 1 3 5 0 6 6 4
Height: 167 cm	Length: 11 cm	Width: 41 cm	Weight: 0,44 kg	Retail box: 5	Oldart.no. 135066	



- For raking long, loose grass or branches, as well as preparing planting beds.
- Leveling function for evening soil beds.
- Lightweight, yet durable, aluminium shaft.

Solid™ Shaft					Art.no. 1014913	EAN 6 4 1 1 5 0 1 3 5 0 0 1 5
Height: 157,5 cm	Length: 3 cm	Width: 2,8 cm	Weight: 0,31 kg	Retail box: 10	Oldart.no. 135001	



- Lightweight and durable aluminium construction.
- Compatible with Solid™ rake heads (article No 1063089, 1014915 & 1014917).
- Spare part for rakes (article No 1003465, 1063090 & 1003466).

Solid™ Leaf Rake, L head					Art.no. 1014915	EAN 6 4 1 1 5 0 1 3 5 0 1 4 5
Height: 22,8 cm	Length: 5,4 cm	Width: 51,1 cm	Weight: 0,23 kg	Retail box: 10	Oldart.no. 135014	



- Wide rake for working on large lawn areas.
- Sturdy and flexible tines with specific geometry prevent twigs and leaves from getting caught.
- Complementary to Solid™ Shaft (article No 1014913).
- Spare part for rake (article No 1003465).

Solid™ Leaf Rake, M head					Art.no. 1063089	EAN 6 4 1 1 5 0 1 7 0 4 3 4 4
Height: 21,2 cm	Length: 6,4 cm	Width: 41,5 cm	Weight: 0,15 kg	Retail box: 10	Oldart.no. -	



- Medium-sized all-purpose rake for working in smaller areas like around trees or under bushes.
- Sturdy tines work well on rooty and uneven surfaces.
- Complementary to Solid™ Shaft (article No 1014913).
- Spare part for rake (article No 1063090).

Solid™ Universal Garden Rake					Art.no. 1014917	EAN 6 4 1 1 5 0 1 3 5 0 6 4 0
Height: 41 cm	Length: 11,4 cm	Width: 15,2 cm	Weight: 0,25 kg	Retail box: 10	Oldart.no. 135064	



- For raking long, loose grass or branches and for preparing planting beds.
- Leveling function to even the soil bed.
- Complementary to Solid Shaft (article No 1014913).
- Spare part for rake (article No 1003466).

Solid™ Rakes

Solid™ leaf and lawn rakes feature an impressively lightweight design that makes every stroke effortless. Durable, plastic tines are great for raking and general clearing - season after season.



SOLID XL

- Features durable tines and a strong, yet lightweight aluminium handle, making it ideal for raking and moving large quantities of leaves and lawn debris



SOLID L

- Wide rake for working on large lawn areas
- Sturdy and flexible tines with specific geometry help prevent twigs and leaves from getting caught



SOLID M

- Medium-sized all-purpose rake for working around trees or under bushes
- Sturdy tines work well on rooty and uneven surfaces



SOLID UNIVERSAL

- For raking loose grass and branches
- Great for preparing planting beds
- Lightweight, durable aluminium handle

Grass Shears

Fiskars grass shears are ergonomically designed with unique, user-friendly features. Our ingenious Servo-System™ technology prevents blades from jamming. Additionally, blades are made from hardened stainless steel for long durability.



POWERLEVER™
Cutting head adjusts
up to 270°



SERVO-SYSTEM™
Cutting head adjusts
up to 360°



SERVO-SYSTEM™
Cutting head adjusts
up to 360°

Grass Shears

PowerLever™ Grass and Hedge Shears (GS53)

Height: 90 cm	Length: 15,5 cm	Width: 20,5 cm	Weight: 1,31 kg	Retail box: 4	Art.no. 1001565	EAN 6 411502 967106
					Oldart.no. 113710	



- For cutting grass, hedges and small bushes.
- Cuts up to 10 mm at the base of the blade and reaches up to 2,5 m.
- Cutting head adjusts up to 270°.

Servo-System™ Grass Shears, Long (GS46)

Height: 105 cm	Length: 8 cm	Width: 25 cm	Weight: 0,74 kg	Retail box: 4	Art.no. 1000590	EAN 6 411501 966902
					Oldart.no. 113690	



- For trimming lawn edges standing up.
- Cutting angle adjustable to 360°.
- Ergonomic handle with finger protection.
- Servo-System™ technology prevents the blades from jamming.

Servo-System™ Grass Shears (GS42)

Height: 34,4 cm	Length: 4,5 cm	Width: 12 cm	Weight: 0,31 kg	Retail box: 4	Art.no. 1000589	EAN 6 411501 966803
					Oldart.no. 113680	



- For trimming lawn edges and hedges.
- Cutting angle adjustable to 360°.
- Ergonomic handle with finger protection.
- Servo-System™ technology prevents the blades from jamming.

SmartFit™ Grass Shears (GS40)

Height: 38 cm	Length: 3 cm	Width: 13 cm	Weight: 0,35 kg	Retail box: 5	Art.no. 1023632	EAN 6 411501 120106
					Oldart.no. -	



- For trimming lawn edges and hedges.
- Cutting angle adjustable to 180°.
- Ergonomic handle with finger protection.

Grass Shears, white (GS41)

Height: 43 cm	Length: 3,2 cm	Width: 13 cm	Weight: 0,28 kg	Retail box: 5	Art.no. 1026917	EAN 6 411501 150288
					Oldart.no. -	



- For trimming lawn edges and hedges.
- White colour for added visibility.
- Cutting angle adjustable to 180°.
- Ergonomic handle with finger protection.

Solid™ Grass Shears (GS21)

Height: 31,5cm	Length: 4,5cm	Width: 8,5cm	Weight: 0,32kg	Retail box: 4
-----------------------	----------------------	---------------------	-----------------------	----------------------

Art.no. **1026826**Oldart.no. **-**

EAN



- For trimming lawn edges and hedges.
- Non-slip handles for comfortable grip.

Grass Shears (S50)

Height: 22cm	Length: 1cm	Width: 9,5cm	Weight: 0,09kg	Retail box: 3
---------------------	--------------------	---------------------	-----------------------	----------------------

Art.no. **1000557**Oldart.no. **111090**

EAN



- For trimming lawn edges and hedges.
- SoftGrip™ cover in upper handle for increased comfort.
- Precise and easy cutting thanks to adjustable blade tension and power-saving spring mechanism.

Plant seeds, help bees.

Weed Pullers

Our sturdy range of weed pullers offer a range of features including an ergonomic handle design, an adjustable shaft with SmartFit™ technology that adapts to different size users, and beautifully designed white and Solid™ weed pullers with light, aluminium construction for ease of use.



XACT™
Ergonomic grip design



SMARTFIT™
Adjustable shaft length



WHITE
Beautiful white design



SOLID™
Light weight aluminium

Weed Pullers

Xact™ Weed Puller

Height: 100 cm Length: 10 cm Width: 30 cm Weight: 0,95 kg Retail box: 4

Art.no. 1020126

Oldart.no. 139950



- For effortless removal of root weeds.
- Ergonomically designed handle.

SmartFit™ Weed Puller

Height: 102 cm Length: 11,9 cm Width: 30 cm Weight: 1,25 kg Retail box: 4

Art.no. 1020125

Oldart.no. 139960



- For ergonomic, effortless removal of root weeds.
- Telescopic aluminium shaft can be adjusted between 990-1190 mm.
- Large, D-shaped handle fits all hand sizes.

Weed Puller, white

Height: 93 cm Length: 9 cm Width: 30 cm Weight: 0,90 kg Retail box: 4

Art.no. 1020127

Oldart.no. 139940



- Light for ergonomic, effortless removal of root weeds.

Solid™ Weed Puller

Height: 93 cm Length: 9 cm Width: 30 cm Weight: 0,90 kg Retail box: 4

Art.no. 1026652

Oldart.no. -



- For effortless removal of root weeds.

Easy and effective weeding

1



Push weed puller blades into the ground, surrounding the weed.

2



Press the pedal with your foot to the ground. Then remove your foot and pull the shaft.

3



Pull weeder up and eject weed.

Classic & Solid™ Lawn Care Tools

Classic Lawn Edger					Art.no. 1003707	EAN 6 4 1 1 5 0 1 3 6 8 6 0 7
Height: 104,2cm	Length: 4 cm	Width: 23,7 cm	Weight: 1,00 kg	Retailbox: 4	Oldart.no. 136860	



- Optimal for cutting straight edges on planting beds and lawns.
- After cutting a straight line with the lawn edger, remove weeds or soil blocks with the help of a spade, fork or cultiweeder.
- FSC® certified wood.

Solid™ Lawn Edger					Art.no. 1011617	EAN 7 3 1 7 7 9 7 0 3 5 0 0 3
Height: 110 cm	Length: 3 cm	Width: 30,5 cm	Weight: 1,85 kg	Retailbox: 3	Oldart.no. 5371	



- Durable all steel construction.
- Optimal for cutting straight edges on lawns and planting beds.

Solid™ Gripper					Art.no. 1062271	EAN 6 4 1 1 5 0 1 3 1 1 4 6 7
Height: 87,5 cm	Length: 5 cm	Width: 17 cm	Weight: 0,40 kg	Retailbox: 5	Oldart.no. -	



- Ergonomic, standing position makes it easy to collect debris from the ground.
- Rubber pads grip easily on to paper, leaves, sticks and other debris.
- Steel shaft.

Pop-Up Bags

Ergo™ Pop-up Bag, S, 73L					Art.no. 1028371	EAN 6 4 1 1 5 0 1 6 0 0 1 8 9
Height: 45 cm	Length: 4 cm	Width: 45 cm	Weight: 0,71 kg	Retailbox: 10	Oldart.no. -	



- Ideal for collecting wet yard and garden waste like damp leaves, weeds or grass clippings.
- Folds to 3 cm for space-saving storage.
- Internal spring pops it up for use.
- Tear- and mildew-resistant construction provides durability and easy cleaning.
- Height closed: 30 mm, Height open: 460 mm.

Ergo™ Pop-up Bag, M, 175L					Art.no. 1028372	EAN 6 4 1 1 5 0 1 6 0 0 1 9 6
Height: 53 cm	Length: 4 cm	Width: 53 cm	Weight: 1,21 kg	Retailbox: 8	Oldart.no. -	



- Ideal for collecting wet yard and garden waste like damp leaves, weeds or grass clippings.
- Folds to 3 cm for space-saving storage.
- Internal spring pops it up for use.
- Tear- and mildew-resistant construction provides durability and easy cleaning.
- Height closed: 30 mm, Height open: 700 mm.

Ergo™ Pop-up Bag, L, 219L					Art.no. 1028373	EAN 6 4 1 1 5 0 1 6 0 0 2 0 2
Height: 59 cm	Length: 4 cm	Width: 59 cm	Weight: 1,63 kg	Retailbox: 6	Oldart.no. -	



- Ideal for collecting wet yard and garden waste like damp leaves, weeds or grass clippings.
- Folds to 3 cm for space-saving storage.
- Internal spring pops it up for use.
- Tear- and mildew-resistant construction provides durability and easy cleaning.
- Height closed: 30 mm, Height open: 700 mm.

Solid™ Pop-up Garden Bag, 56 l					Art.no. 1015646	EAN 6 4 1 1 5 0 1 3 5 0 4 1 1
Height: 40 cm	Length: 3 cm	Width: 40 cm	Weight: 0,60 kg	Retailbox: 6	Oldart.no. 135041	



- Ideal for collecting weeds, grass clippings, other types of yard waste.
- Folds to 3 cm for space-saving storage.
- Internal spring pops it up for use.
- Tear- and mildew-resistant construction provides durability and easy cleaning.
- Height closed: 30 mm, Height open: 460 mm.

Solid™ Pop-up Garden Bag, 172 l					Art.no. 1015647	EAN 6 4 1 1 5 0 1 3 5 0 4 2 8
Height: 56 cm	Length: 3 cm	Width: 56 cm	Weight: 1,25 kg	Retailbox: 6	Oldart.no. 135042	



- Ideal for collecting weeds, grass clippings or other types of yard waste.
- Folds to 4 cm for space-saving storage.
- Internal spring pops it up for use.
- Tear- and mildew-resistant construction provides durability and easy cleaning.
- Height closed: 40 mm, Height open: 700 mm.

StaySharp™

Fiskars StaySharp™ Max Reel Mower promotes greener, healthier lawns by cleanly cutting each blade of grass with a scissors-like action. This minimises the lawn's moisture loss, while reducing exposure to disease.



A reel mower lets you cut grass without noise, uncomfortable vibrations, or any of the hazards associated with power-driven rotary blades. It is one of the most environmentally-friendly ways to cut your lawn.

- StaySharp™ cutting system cuts without unwanted contact for long-lasting performance
- Precision-ground, hardened steel blades
- Ergonomic, height-adjustable handle with padded grip for more comfort
- Directs clippings away from your feet

StaySharp™ Reel Mowers

StaySharp™ Max Reel Mower

Height: **60 cm** Length: **61 cm** Width: **37 cm** Weight: **23,5 kg** Retail box: **1**

Art.no. **1000591**

Old art.no. **113880**



- 2x more cutting power compared to standard reel mowers.
- 60% easier to push than other reel mowers.
- Cut height adjustable between 2,5 - 10 cm.
- Compatible with grass catcher.

StaySharp™ Plus Reel Mower

Height: **60 cm** Length: **34,5 cm** Width: **45,5 cm** Weight: **18 kg** Retail box: **1**

Art.no. **1015649**

Old art.no. **113872**



- 75% more cutting power compared to standard reel mowers.
- 40% easier to push than other reel mowers.
- Cut height adjustable between 3,8 - 8,9 cm.

StaySharp™ Grass Catcher

Height: **54,5 cm** Length: **55 cm** Width: **6 cm** Weight: **1,59 kg** Retail box: **1**

Art.no. **1000592**

Old art.no. **113883**



- Simple, tool-free assembly with Fiskars StaySharp™ Max Mower.
- Effective capacity of approximately 18 litres.
- UV- and mildew-resistant polyester screen with heavy-duty steel frame for long-lasting performance.

Soil Care

Growing & Planting [p.80](#)

Indoor Gardening [p.82](#)

Harvesting [p.88](#)

Spades, Shovels & Forks [p.91](#)

QuikDrill™ [p.103](#)

Classic Spades & Forks [p.104](#)

Cultivating Tools [p.110](#)

Nursery Tools [p.116](#)



Planting and growing

The right tools for every planting task:



1 Large hole for dropping bulbs or seedlings
Maximum size 55 mm

2 Handles made from ultra durable composite material

3 Shaft made from lightweight aluminium

4 Lock
Lock the blade in open position for planting

5 Depth 150mm



How to use



1 Press blade tip into ground by pressing the pedal.

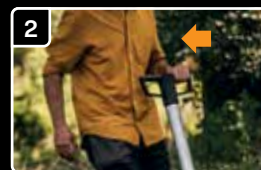

2 Pull handle toward your self to open up hole until you hear a click.



3 Drop your bulb or sapling through the top of the planter. Size up to 50 mm.



4 Pull planter from the ground, cover your bulb and tap down with your foot.



Ergo™ Standing bulb planter

1 Convenient handle and lever
To loosen and aerate the soil

2 Sturdy steel shaft

3 Stable stepping board
For better control

4 Circular motion and sharp teeth
Allow the tool to pass easily through dense soil



Solid™ Seed planting trowel

Offers four seed-planting essentials in one lightweight, durable tool



Solid™ Hand spreader

Use to spread seeds, salt, sand, fertilizer and more



Solid™ Hand bulb planter

Durable, FiberComp™ reinforced plastic body

Comfortable handle
For loosening the soil

Easy depth scale
Measurements in centimeters and inches

Circular motion and sharp teeth
Help to pass through tight ground



Solid™ Planting stick

Creates divots and holes for planting seeds at the correct depth



Urban Plant care

Fiskars Plant Care tools help transform your home, patio, balcony into a lush, green oasis

Features & benefits

New hand tools

Medium Soil Scoop:

- Deeper edges to move larger quantities of soil
- Fits ergonomically in your hand

2-in-1 Soil Scoop & Brush:

- Larger side & smaller side for ease of pouring and mixing soil
- Flexible material gives additional control over a regular scoop
- Small easy to handle brush to easy clean some of the mess out
- Double-sided scoop can also be used as a shovel

Watering can

Benefits:

- Holds 1,2L
- Perfect for smaller spaces but not too small to have to run back and forth too many times to fill
- Drip resistant pour spout

Tool box

Benefits:

- Easy storage for all the items
- Can fit plant mat, tool set, mister and watering can.



Plant Care

Indoor Plant care

Watering can

Height: 30,6cm Length: 13,7cm Width: 13,3cm Weight: 0,3kg Retail box: 4

Art.no. 1071307



Old art.no. -



Plant Care

- Ideal for gently and precisely waters plants on city balconies, patios and indoors.
- Long, slim spout reaches high and low plants, and waters at the plant base for healthier growth.
- Easy-fill top allows you fill watering can without removing cap.
- Durable, lightweight, resin body is made of 30% post-consumer recycled plastic.

Mister

Height: 22,9cm Length: 7,9cm Width: 10,6cm Weight: 0,1kg Retail box: 4

Art.no. 1071306



Old art.no. -



Plant Care

- Ideal for hydrating delicate plants and for cleaning debris from broad leaves.
- Delivers a fine, even mist to indoor and outdoor plants and succulents.
- Nozzle locks for storage and transport.
- Durable, lightweight, resin body is made of 30% post-consumer recycled plastic.

Tool box

Height: 17,5cm Length: 34,9cm Width: 31,4cm Weight: 1kg Retail box: 4

Art.no. 1071305



Old art.no. -



Plant Care

- Stores tools and supplies for easy access and transportation from indoors to out.
- Spacious design includes a removable bin with holes for wall-mounting - perfect for snips, pruners and more.
- Handle locks in place for one-handed carrying, or use side handles for two-handed carrying.
- Body is made of durable, lightweight, resin with 20% post-consumer recycled plastic.
- Dimensions: 35,3 cm x 31,1 cm x 17,3 cm.

Planting mat

Height: 28,9cm Length: 3,5cm Width: 29,5cm Weight: 0,8kg Retail box: 4

Art.no. 1071304



Old art.no. -



Plant Care

- Ideal for protecting work surfaces and making cleanup fast and easy.
- Inner panels fold in multiple ways, allowing you to pour loose materials back into bag, minimising waste.
- Outer layer is made of durable, water-resistant nylon that easily wipes clean.
- Mat unfolds to 82,5cm x 44,5cm for a generously sized working area.

Soil scoop

Height: 34,9cm Length: 6cm Width: 8,6cm Weight: 0,1kg Retail box: 4

Art.no. 1071303



Old art.no. -



Plant Care

- Perfectly sized for transferring soil from bags into medium-sized planters when potting and transplanting patio gardens and houseplants.
- Flat bottom keeps scoop from tipping when set on a flat surface.
- Deep sides maximize capacity and prevent spills.
- Made of durable, lightweight resin with 20% post-consumer recycled plastic.

2-in-1 soil scoop and brush

Height: 27 cm	Length: 4,8 cm	Width: 9,5 cm	Weight: 0,1kg	Retail box: 4
---------------	----------------	---------------	---------------	---------------

Art.no. 1071302

EAN



Oldart.no. -



Plant Care

- Ideal for digging, re-potting, transplanting and cleaning up loose planting materials.
- Soft, long brush bristles sweep dirt and debris onto wide side of scoop for fast, easy cleanup.
- Two-sided scoop has narrow rigid end for precisely placing, tapping down and digging into soil.
- Scoop's wide, flexible end functions as a dustpan and for pouring soil.
- Brush handle is made of durable resin with 20% post-consumer recycled plastic.

Bulb planters

Features & benefits

Xact™ Standing bulb planter

Perfect for planting bulbs and small saplings without bending

- 1 Release button
- 2 Aluminium shaft & FiberComp™ handle
- 3 Planting depth 150 mm
- 4 Max. bulb size 55 mm

Ergo™ Bulb planter

- Comfortable handle for loosening the soil
- Circular motion and sharp teeth allow it to pass easily through dense soil
- Stainless steel shaft & FiberComp™ handle

Solid™ Hand bulb planter

- Durable, glass fiber reinforced plastic body
- Comfortable handle for loosening the soil
- Circular motion and sharp teeth help to pass through tight ground
- Easy-to-clean surface



How to use

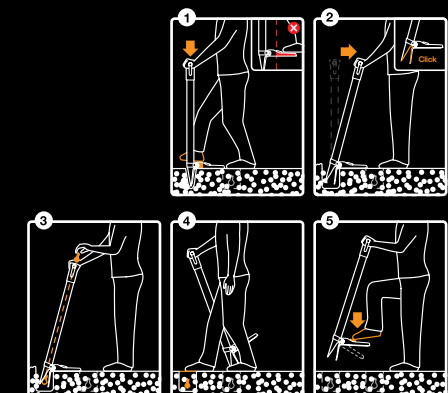

Planting Tools

Xact™ Standing Bulb Planter					Art.no. 1057077	EAN 6 411501 311320
Height: 105,3cm	Length: 31cm	Width: 30cm	Weight: 2kg	Retail box: 4	Oldart.no. -	



- Allows you to plant bulbs and small saplings up to 50mm, without bending or kneeling.
- Durable, lightweight aluminium shaft has a bladed end and stepping pedal for effortless hole creation.
- A locking mechanism on the stepping pedal holds the blade open, allowing you to drop your bulb through the top of the planter for perfect placement.
- Pull planter from the ground, cover your bulb, and tap down with your foot.
- Planting depth up to 150 mm.

Ergo™ Standing Bulb Planter					Art.no. 1057078	EAN 6 411501 311337
Height: 99,5cm	Length: 10,5cm	Width: 27,5cm	Weight: 1,93kg	Retail box: 4	Oldart.no. -	



- Digs and fills holes for less time kneeling and bending.
- Non-slip standing board allows you to easily push the tool into the ground.
- Cone features sharp teeth for powering through even tough soil.
- Handle trigger releases soil over the bulb and hole for quick, efficient planting.
- Shaft is made of durable steel for years of reliable use.
- Planting depth up to 150 mm.

Solid™ Hand Bulb Planter					Art.no. 1057079	EAN 6 411501 311344
Height: 24,3cm	Length: 10,3cm	Width: 11,7cm	Weight: 0,25kg	Retail box: 12	Oldart.no. -	



- Ideal for quick and precise planting of bulbs and seedlings.
- Blade has teeth for fast and efficient digging using a circular motion.
- Planter features measuring guide on side for accurate depth.
- A simple trigger opens the blade to release soil over the hole and bulb.
- Suited for bulbs up to 65 mm wide and planting depth of up to 125 mm.
- Made of durable, weather-resistant FiberComp™.

Solid™ Planting Tools

Solid™ Seed Planting Trowel					Art.no. 1057641	EAN 6 411501 311276
Height: 33cm	Length: 6,4cm	Width: 2,2cm	Weight: 0,06kg	Retail box: 16	Oldart.no. -	



- Offers four seed-planting essentials in one lightweight, durable tool.
- Unique tool features a trowel, stylus, widger and measuring tool, all integrated into one 2-piece tool.
- Debossed, easy to read, English and metric measurements on trowel and widger won't fade or erode.
- Made of lightweight, rust-proof FiberComp™ for superior durability.

Solid™ Planting Stick					Art.no. 1057080	EAN 6 411501 311351
Height: 26,2cm	Length: 3cm	Width: 13cm	Weight: 0,08kg	Retail box: 16	Oldart.no. -	



- Creates divots and holes for planting seeds at the correct depth.
- Measuring scale on tip of tool allows for depth of up to 150 mm.
- Unique L-shaped handle provides maximum torque and comfort.
- Lightweight, yet incredibly strong, FiberComp™ construction is weather-resistant and easy to clean.

Solid™ Spreader					Art.no. 1057076	EAN 6 411501 311313
Height: 30cm	Length: 13,1cm	Width: 16,5cm	Weight: 0,28kg	Retail box: 12	Oldart.no. -	



- Ideal for accurate spreading of sand, salt, fertilizer and more.
- Easy-to-turn adjustment knob controls dosing while deploying your material. Choose from pour, fast flow or slower flow options.
- Easy-lock system allows for quick refilling with spreading materials.

Harvesting tools

Intuitive tools made with durable & lightweight materials for easy, quick harvesting

X-series™ Harvesting knife

Ideal for harvesting produce with thick stalks. It has a stainless steel blade with a flat tip for quick push cuts and a serrated section for slicing through fibrous stems.

Fixed-blade knife includes sheath and belt loop for storage, safety & convenience.



Plus™ Harvesting basket

Perfect for collecting, transporting and washing your harvest and tools.



X-series™ Folding produce knife

Ideal for clean and precise cuts on smaller stalks and stems. It folds for convenience and compact storage.

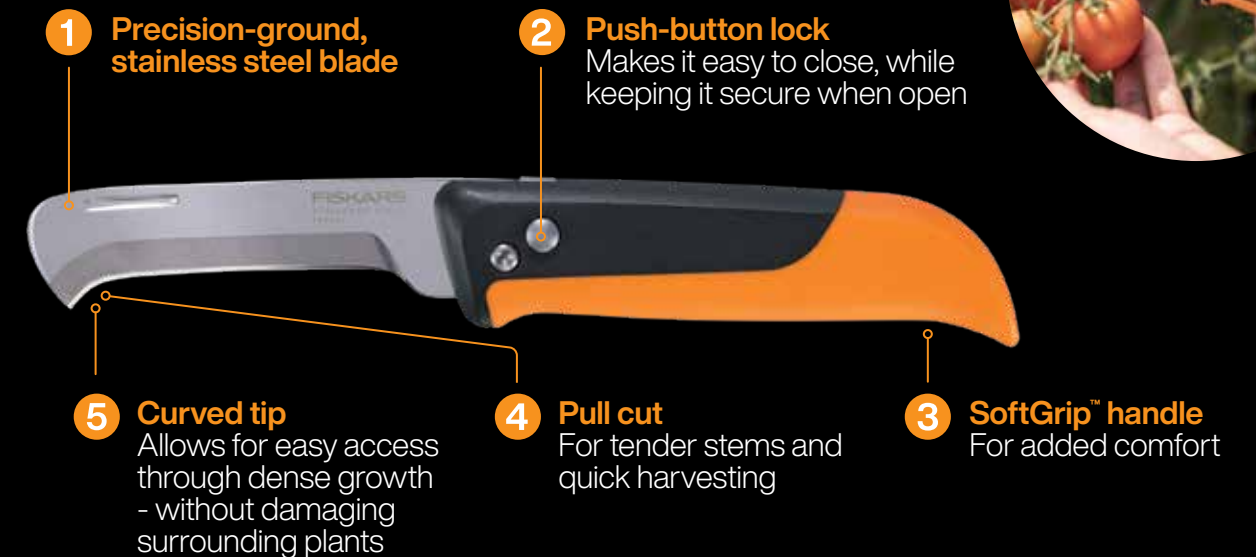

Harvesting Tools

X-series™ Folding produce knife K80

Height: 18,42 cm Length: 1,83 cm Width: 10,8 cm Weight: 0,07 kg Retail box: 8

Art.no. 1062819

EAN



- Fiskars® X-series™ Folding Produce Knife is ideal for harvesting from smaller stalks and stems.
- Precision-ground, stainless steel blade is curved at the tip, for easy access through dense growth without damaging surrounding plants.
- Foldable, ergonomic design offers comfort and compact storage.
- Blade length: 7,7 cm.
- 25-year warranty.

X-series™ Harvesting knife K82

Height: 34,62 cm Length: 3,81 cm Width: 6,99 cm Weight: 0,25 kg Retail box: 8

Art.no. 1062830

EAN



- Fiskars® X-series™ Harvesting Knife is ideal for harvesting thick stalks and stems.
- Precision-ground, stainless steel blade has a flat tip for quick push cuts and a serrated section for saw cuts through fibrous plants.
- Extended tang for durability and ergonomic handle for comfort and control.
- Includes hard plastic sheath with belt loop.
- Blade length: 15 cm.
- 25-year warranty.

Plus™ Garden Harvest Basket

Height: 60,96 cm Length: 13,67 cm Width: 38,84 cm Weight: 1,13 kg Retail box: 6

Art.no. 1062831

EAN



- Fiskars® Plus™ Garden Harvest Basket is perfect for collecting, transporting and washing your harvest and food gardening tools.
- Colander side has drain holes for washing freshly harvested produce, while enclosed side can be used for soaking or carrying clean produce or tools.
- Ergonomic side handles are ideal for two-handed carrying, while folding handles interlock for comfortable, one-handed use.
- Dimensions: 61 cm x 39 cm x 13 cm.

Solid™ Kneeling pad

Height: 1,91 cm Length: 45,72 cm Width: 27,94 cm Weight: 0,08 kg Retail box: 6

Art.no. 1062832

EAN



- Fiskars® Solid™ Kneeling Pad prevents sore knees when working in the garden.
- Dual-layer construction provides lasting durability.
- Moisture-proof outer shell protects you from rough terrain.
- Soft foam inner cushion provides generous padding.
- Convenient handle makes carrying easy.
- Sized to offer plenty of room while working.
- Dimensions: 45,7 cm x 27,9 cm x 1,9 cm.

Digging

To make digging as easy as possible, you need a reliable spade suitable for the task. That's why we've developed a variety of spades and shovels including spades for digging in hard soil, edging and planting, as well as light spades for soft soil. We also have shovels designed to move sand, soil and snow.



XACT™

Gardening is a demanding pastime. Fiskars Xact™ digging tools will give you that extra push to take your gardening to a whole new level and make digging a truly pleasurable experience. Fiskars Xact digging tools fit you – combining the right length with lightweight material and durability.

ERGONOMIC™

Beautifully designed and realised, Fiskars Ergonomic™ is a perfect selection of tools for digging and composting – all for the most discerning gardener. The spades, shovels and forks have angled shafts and handles for reduced strain on backs, hands and wrists. A powder coating on the shafts also maximise grip and comfort.

SOLID™



Offering simple, affordable quality and expertise for every garden, Fiskars Solid™ range includes a wide variety of shovels, spades and forks designed to get the job done. With metal or FSC® certified wooden shafts, and straight or D-shaped handles, every Solid tool features the quality Fiskars is known for.

WHITE

The new beautiful White range offers you a selection of lightweight tools for planting, cultivating, raking and other gardening tasks. Fiskars versatile range of soil rakes, hoes and cultivators are ideal for weed control, moving soil, creating narrow furrows for planting seeds and bulbs and even harvesting root crops.





Xact™ Spades, Shovels & Forks

Xact™ Pointed Spade					Art.no. 1066729	EAN 6 411501 311627
Height: 120 cm	Length: 8 cm	Width: 19,2 cm	Weight: 1,95 kg	Retailbox: 4	Oldart.no. -	



- Ideal for digging holes, edging beds and removing small amounts of soil.
- Non-slip stepping board.
- Sharpened blade edge and sides that easily cut through soil and roots.
- Measurement scale on blade for precise digging.
- Comfortable handle with SoftGrip™ ensures digging comfort control.
- Ergonomic angled shaft that ensures ideal working position.

Xact™ Rounded Spade					Art.no. 1066730	EAN 6 411501 311634
Height: 120 cm	Length: 8,9 cm	Width: 19,2 cm	Weight: 2,01 kg	Retailbox: 4	Oldart.no. -	



- Ideal for edging and planting in standard, grassy topsoil.
- Non-slip stepping board.
- Sharpened blade edge and sides that easily cut through soil and roots.
- Measurement scale on blade for precise digging.
- Comfortable handle with SoftGrip™ ensures digging comfort control.
- Ergonomic angled shaft that ensures ideal working position.

Xact™ Shovel					Art.no. 1066731	EAN 6 411501 311641
Height: 130,4 cm	Length: 15,9 cm	Width: 22,3 cm	Weight: 2,19 kg	Retailbox: 4	Oldart.no. -	



- Ideal for moving soil, sand, gravel and other bulk materials.
- Wide, angled head allows you to shift materials quickly and with less strain on your back.
- D-shaped handle with SoftGrip™ ensures comfort and control.
- Ergonomic angled shaft that ensures ideal working position.

Xact™ Telescopic Pointed Spade					Art.no. 1066732	EAN 6 411501 311658
Height: max 130 cm	Length: 8,2 cm	Width: 19,2 cm	Weight: 1,94 kg	Retailbox: 4	Oldart.no. 1001567	



- Ideal for digging holes, edging beds and removing small amounts of soil.
- Non-slip stepping board.
- Sharpened blade edge and sides that easily cut through soil and roots.
- Measurement scale on blade for precise digging.
- Telescopic shaft extends from 110.8 cm to 130 cm.
- D-shaped handle with SoftGrip™ ensures digging comfort control.
- Ergonomic angled shaft that ensures ideal working position.

Xact™ Telescopic Rounded Spade					Art.no. 1066733	EAN 6 411501 311665
Height: max 130 cm	Length: 9,1 cm	Width: 19,2 cm	Weight: 1,99 kg	Retailbox: 4	Oldart.no. 1000620	



- Ideal for edging and planting in normal, grassy topsoil.
- Non-slip stepping board.
- Sharpened blade edge and sides that easily cut through soil and roots.
- Boron steel head is welded to a composite and steel shaft for ultimate durability.
- Measurement scale on blade for precise digging.
- Telescopic shaft extends from 110.8 cm to 130 cm
- D-shaped handle with SoftGrip™ ensures digging comfort control.
- Ergonomic angled shaft that ensures ideal working position.

Xact™ Telescopic Shovel					Art.no. 1066734	EAN 6 411501 311672
Height: max 140 cm	Length: 15,9 cm	Width: 22,3 cm	Weight: 2,19 kg	Retailbox: 4	Oldart.no. -	



- Ideal for moving soil, sand, gravel and other bulk materials.
- Wide, angled head allows you to shift materials quickly and with less strain on your back.
- Telescopic shaft extends from 120.8 cm to 140 cm.
- D-shaped handle with SoftGrip™ ensures digging comfort control.
- Ergonomic angled shaft that ensures ideal working position.

Xact™ Garden Fork					Art.no. 1070716	EAN 6 411501 705648
Height: 120 cm	Length: 6,9 cm	Width: 18,5 cm	Weight: 1,2 kg	Retailbox: 4	Oldart.no. -	

- Ideal for breaking up and turning over tough, compacted soil.
- Features an exceptionally durable yet lightweight build.
- Shaft and handle are angled to keep your body in a natural position, reducing strain while you work.
- D-shaped handle is suitable for all hand sizes with or without gloves.

Xact™ Telescopic Garden Fork					Art.no. 1070717	EAN 6 411501 705655
Height: 110-130 cm	Length: 6,9 cm	Width: 18,5 cm	Weight: 1,8 kg	Retailbox: 4	Oldart.no. -	

- Ideal for aerating tough soil, raking over stones or weeds and moving tufts of grass while bordering.
- Features an exceptionally durable yet lightweight build that can be adjusted from 110-130 cm.
- Shaft and handle are angled to keep your body in a natural position, reducing strain while you work.
- Shaft includes non-slip grip which enhances control and insulates from cold.
- D-shaped handle is suitable for all hand sizes with or without gloves.

Ergonomic™ Spades, Shovels & Forks

Ergonomic™ Pro Pointed XL Spade Black					Art.no. 1066707	EAN 6 411501 311689
Height: 130,5cm	Length: 13,5cm	Width: 20,5cm	Weight: 2,3kg	Retail box: 4	Oldart.no. -	



- Ergonomic™ Pro Pointed XL spade is designed for demanding, specialised tasks and heavy lifting.
- Ideal for driving into stone, clay and hard soils.
- Stepping board helps drive into tough soil.
- D-shaped handle is sized for working with or without gloves.
- Angled shaft with non-slip grip offers added strength and improved ergonomics.

Ergonomic™ Pro Drainage Shovel Black					Art.no. 1066709	EAN 6 411501 311702
Height: 130,7cm	Length: 9,3cm	Width: 15,8cm	Weight: 2,14kg	Retail box: 4	Oldart.no. -	



- Ergonomic™ Pro Drain spade is designed for demanding, specialised tasks and heavy lifting.
- Ideal for trenching and digging up bulbs in tough soil, as well as splitting roots.
- Stepping board helps drive into tough soil.
- D-shaped handle is sized for working with or without gloves.
- Angled shaft with non-slip grip offers added strength and improved ergonomics.

Ergonomic™ Pro Shovel Black					Art.no. 1066711	EAN 6 411501 311719
Height: 131,7cm	Length: 17,3cm	Width: 23cm	Weight: 2,26kg	Retail box: 4	Oldart.no. -	



- Ergonomic™ Pro Shovel is designed for demanding, specialised tasks and heavy lifting.
- Ideal for transferring heavy construction and garden materials like gravel, mulch, soil and sand.
- D-shaped handle is sized for working with or without gloves.
- Angled shaft with non-slip grip offers added strength and improved ergonomics.

Ergonomic™ Pro Concrete Shovel Black					Art.no. 1066713	EAN 6 411501 311726
Height: 123,9cm	Length: 14cm	Width: 27,4cm	Weight: 2,4kg	Retail box: 4	Oldart.no. -	



- Ergonomic™ Pro Concrete shovel is designed for demanding, specialised tasks and heavy lifting.
- Ideal for transferring and mixing and spreading heavy-duty and wet materials.
- D-shaped handle is sized for working with or without gloves.
- Angled shaft with non-slip grip offers added strength and improved ergonomics.

Ergonomic™ Small Spade Grey					Art.no. 1066714	EAN 6 411501 311757
Height: 123cm	Length: 8,3cm	Width: 15,3cm	Weight: 2,1kg	Retail box: 4	Oldart.no. -	



- Saw-toothed edge is ideal for cutting through roots and digging in rocky soil.
- D-shaped handle ensures a comfortable and firm grip.
- Tear-drop shaped steel shaft with a plastic coating makes it extremely durable, maximises grip and insulates from the cold.
- Sturdy welded connection between the blade and the shaft ensures rigid durability.

Ergonomic™ Pointed Spade					Art.no. 1066708	EAN 6 411501 311733
Height: 124,9cm	Length: 12cm	Width: 19,3cm	Weight: 2,06kg	Retail box: 4	Oldart.no. 1001568	



- Ergonomic™ Pointed spade is optimised for comfort — working with your body.
- Sharp cutting edge is ideal for aerating, stirring and turning soil, cutting through roots, and digging in stone, clay and hard soil.
- D-shaped handle is sized for working with or without gloves.
- Ergonomically shaped shaft with non-slip grip that insulates from the cold.
- Stepping board adds extra strength and makes driving into tough soil easier.
- Perfected lifting angle for improved comfort and optimal digging performance.

Ergonomic™ Rounded Spade					Art.no. 1066710	EAN 6 411501 311740
Height: 125cm	Length: 13,5cm	Width: 19,3cm	Weight: 2,07kg	Retail box: 4	Oldart.no. 1001411	



- Ergonomic™ Rounded spade is optimised for comfort — working with your body.
- Sharp cutting edge is ideal for digging, edging and planting in standard, grassy topsoil.
- Ergonomically shaped shaft with non-slip grip that insulates from the cold.
- Stepping board adds extra strength and makes driving into tough soil easier.
- Perfected lifting angle for improved comfort and optimal digging performance.

Ergonomic™ Shovel					Art.no. 1066712	EAN 6 411501 311764
Height: 131,7cm	Length: 17,3cm	Width: 23cm	Weight: 2,26kg	Retail box: 4	Oldart.no. 1001579	



- Ergonomic™ Shovel is optimised for comfort — working with your body.
- Wide scoop head is ideal for moving bulky materials, including gravel, sand and soil.
- Ergonomically shaped shaft with non-slip grip that insulates from the cold.
- Perfected lifting angle for improved comfort and optimal digging performance.

Ergonomic™ Compost Fork Grey					Art.no. 1070678	EAN 6 411501 705563
Height: 136cm	Length: 10,7cm	Width: 22cm	Weight: 1,8kg	Retail box: 4	Oldart.no. -	



- Thin, forged tines are ideal for moving bulky materials like leaves, mulch, hay and cut grass.
- The shaft has an ergonomic lifting angle to minimise strain on back and shoulders.
- Angled handle keeps hands and wrists in a neutral position.
- Boron steel shaft has SoftGrip coating for cold insulation and firm grip.
- Forks are forged for increased strength and durability.

Ergonomic™ Garden Fork Grey					Art.no. 1070679	EAN 6 411501 705570
Height: 132,2cm	Length: 10,8cm	Width: 20,5cm	Weight: 2,2kg	Retail box: 4	Oldart.no. -	



- Forged tines are ideal for breaking up soil.
- The shaft has an ergonomic lifting angle to minimise strain on back and shoulders.
- Angled handle keeps hands and wrists in a neutral position.
- Boron steel shaft has SoftGrip coating for cold insulation and firm grip.
- Forks are forged for increased strength and durability.

White Spades & Fork

Pointed Spade S					Art.no. 1067540	EAN 6 411501 311481
Height: 105cm	Length: 8,4cm	Width: 15,3cm	Weight: 2kg	Retail box: 4	Oldart.no. -	



- Sharp blade for digging, edging and planting, and saw-toothed edge for cutting roots.
- Conveniently sized for gardening in small or tight spaces.
- Boron steel head is welded to a lightweight, yet strong, steel shaft for durability.
- D-shaped handle with comfortable grip insulates from the cold.

Pointed Spade					Art.no. 1067519	EAN 6 411501 311474
Height: 105cm	Length: 12cm	Width: 19,3cm	Weight: 1,95kg	Retail box: 4	Oldart.no. -	



- "White" Pointed spade is lightweight, easy to use, and adds a modern style to gardening.
- Pointed blade edge is ideal for digging, edging and planting in standard, grassy topsoil.
- Conveniently sized for gardening in small or tight spaces.
- D-shaped handle with comfortable grip insulates from the cold.
- Stepping board helps you break through soil.

Garden Fork					Art.no. 1070715	EAN 6 411501 705631
Height: 105,1cm	Length: 8,7cm	Width: 18,5cm	Weight: 1,7kg	Retail box: 4	Oldart.no. -	



- Ideal for loosening and turning over soil, harvesting and composting in tight spaces and small vegetable gardens.
- Durable steel construction.
- Shaft features SoftGrip for a non-slip hold while working and insulation from cold.
- D-shaped handle for comfort for hands of all sizes, with or without gloves.
- Handle provides easy hanging storage.

White digging tools

Our white range offers you a selection of lightweight tools for planting, cultivating, raking and other gardening tasks. This versatile range includes soil rakes, hoes and cultivators for weed control, moving soil, creating narrow furrows for planting seeds and bulbs, and even harvesting root crops.

- Oval-shaped, lightweight shaft
- Plastic sleeve maximises grip while insulating from the cold

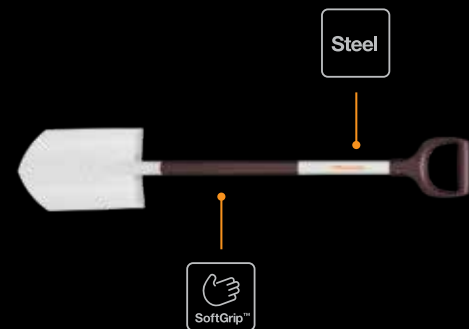

FISKARS®

Happiness is planting deep roots

Landscaping tools
fiskars.com

Solid™+ & Solid™ Spades, Shovels & Forks

Solid™+ Spade XL Blade					Art.no. 1067516	EAN 6 411501 311559
Height: 113,5cm	Length: 14,2cm	Width: 20,5cm	Weight: 2,06kg	Retailbox: 4	Oldart.no. -	



- Solid™+ Spade, XL blade offers affordable quality for every garden.
- Ideal for digging in hard ground like stone and clay.
- Stepping board helps drive into tough soil.
- D-shaped handle is perfect for hands of all sizes, with or without gloves.

Solid™+ Spade XL Blade long shaft					Art.no. 1067517	EAN 6 411501 311566
Height: 126,5cm	Length: 13,4cm	Width: 20,5cm	Weight: 2,20kg	Retailbox: 4	Oldart.no. -	



- Solid™+ Spade, XL blade long shaft offers affordable quality for every garden.
- Ideal for digging in hard ground like stone and clay.
- Long, angled shaft provides ergonomic use for taller users.
- Stepping board helps drive into tough soil.
- D-shaped handle is perfect for hands of all sizes, with or without gloves.

Solid™+ Concrete Shovel					Art.no. 1067518	EAN 6 411501 311573
Height: 122,7cm	Length: 14,1cm	Width: 27,5cm	Weight: 2,45kg	Retailbox: 4	Oldart.no. -	



- Solid™+ Concrete Shovel offers affordable quality for every garden.
- Ideal for working with sand, gravel, wet concrete and other heavy-duty materials.
- Boron steel construction increases strength.
- D-shaped handle is perfect for hands of all sizes, with or without gloves.

Solid™+ Compost Fork					Art.no. 1071936	EAN 6 411501 600479
Height: 129cm	Length: 9cm	Width: 26cm	Weight: 2,10kg	Retailbox: 4	Oldart.no. -	



- Fiskars Solid+ Compost fork offers affordable quality for every garden.
- Ideal for aerating tough soil and turning compost.
- Boron steel head increases strength.
- D-shaped handle provides comfort and fits all hand sizes with or without gloves.

Solid™ Wood Pointed Spade FSC					Art.no. 1066721	EAN 6 411501 311771
Height: 108,5cm	Length: 7,8cm	Width: 18cm	Weight: 1,7kg	Retailbox: 4	Oldart.no. 1014816	



- Solid™ Pointed spade with wood offers affordable quality for every garden.
- Sharp, pointed blade edge is ideal for general digging tasks and for cutting turf or roots.
- Head is welded to metal shaft for optimal durability.
- Authentic wood shaft is FSC® certified.
- Stepping board helps drive into tough soil.
- D-shaped handle is perfect for hands of all sizes, with or without gloves.

Solid™ Wood Rounded Spade FSC					Art.no. 1066722	EAN 6 411501 311788
Height: 108,5cm	Length: 8,4cm	Width: 18cm	Weight: 1,8kg	Retailbox: 4	Oldart.no. 1014817	



- Solid™ Rounded spade with wood offers affordable quality for every garden.
- Rounded blade edge is ideal for digging, edging and planting in standard, grassy topsoil.
- Head is welded to metal shaft for optimal durability.
- Authentic wood shaft is FSC® certified.
- Stepping board helps drive into tough soil.
- D-shaped handle is perfect for hands of all sizes, with or without gloves.

Solid™ Wood Shovel D Handle FSC					Art.no. 1066723	EAN 6 411501 311795
Height: 123cm	Length: 18cm	Width: 23cm	Weight: 2,1kg	Retailbox: 4	Oldart.no. 1014818	



- Solid™ Shovel with wood offers affordable quality for every garden.
- Durable, wide scoop is ideal for efficiently moving dirt, sand, gravel and other bulky garden materials.
- Head is welded to metal shaft for optimal durability.
- Authentic wood shaft is FSC® certified.
- D-shaped handle is perfect for hands of all sizes, with or without gloves.

Solid™ Wood Shovel I Handle FSC					Art.no. 1066724	EAN 6 411501 311801
Height: 143,5cm	Length: 18cm	Width: 23cm	Weight: 2,1kg	Retailbox: 4	Oldart.no. -	



- Solid™ Shovel with wood offers affordable quality for every garden.
- Durable, wide scoop is ideal for efficiently moving dirt, sand, gravel and other bulky garden materials.
- Head is welded to metal shaft for optimal durability.
- Authentic wood shaft is FSC® certified.
- Straight handle offers a traditional, seamless grip.

Solid™ Wood Garden Fork FSC					Art.no. 1070676	EAN 6 411501 705549
Height: 112,6cm	Length: 9,9cm	Width: 18,5cm	Weight: 1,5kg	Retailbox: 4	Oldart.no. -	



- Forged steel tines are ideal for aerating and loosening soil and working the compost heap.
- Authentic wood shaft is FSC® certified.
- D-shaped handle provides comfort.

Solid™ Metal Car Spade					Art.no. 1066715	EAN 6 411501 311825
Height: 80cm	Length: 10,5cm	Width: 18,2cm	Weight: 1,42kg	Retail box: 4	Oldart.no. 1014809	



- Solid™ Car spade is conveniently sized to fit in the boot of your car.
- Pointed blade is ideal for digging out of snow, ice or mud in a hurry.
- Head is welded to metal shaft for optimal durability.
- Easy-to-see orange D-shaped handle is perfect for hands of all sizes, with or without gloves.

Solid™ Metal Pointed Spade					Art.no. 1066716	EAN 6 411501 311832
Height: 116,6cm	Length: 12,1cm	Width: 18cm	Weight: 1,85kg	Retail box: 4	Oldart.no. 1003455	



- Solid™ Pointed spade offers affordable quality for every garden.
- Pointed blade edge is ideal for general digging tasks and for cutting turf or roots.
- Head is welded to a strong metal shaft for optimal durability.
- Stepping board helps drive into tough soil.
- D-shaped handle is perfect for hands of all sizes, with or without gloves.

Solid™ Metal Rounded Spade					Art.no. 1066717	EAN 6 411501 311849
Height: 116,6cm	Length: 12,4cm	Width: 18cm	Weight: 1,90kg	Retail box: 4	Oldart.no. 1003456	



- Solid™ Rounded spade offers affordable quality for every garden.
- Rounded blade edge is ideal for digging, edging and planting in standard, grassy topsoil.
- Head is welded to a strong metal shaft for optimal durability.
- Stepping board helps drive into tough soil.
- D-shaped handle is perfect for hands of all sizes, with or without gloves.

Solid™ Metal Shovel D Handle					Art.no. 1066718	EAN 6 411501 311856
Height: 126,7cm	Length: 17,6cm	Width: 23cm	Weight: 2,13kg	Retail box: 4	Oldart.no. 1003457	



- Solid™ Shovel offers affordable quality for every garden.
- Durable, wide scoop is ideal for efficiently moving dirt, sand, gravel and other bulky garden materials.
- Head is welded to a strong metal shaft for optimal durability.
- D-shaped handle is perfect for hands of all sizes, with or without gloves.

Solid™ Metal Shovel I Handle					Art.no. 1066720	EAN 6 411501 311863
Height: 149cm	Length: 17,4cm	Width: 23cm	Weight: 2,20kg	Retail box: 4	Oldart.no. -	



- Solid™ Shovel offers affordable quality for every garden.
- Durable, wide scoop is ideal for efficiently moving dirt, sand, gravel and other bulky garden materials.
- Head is welded to a strong metal shaft for optimal durability.
- Straight handle offers a traditional, seamless grip.

Solid™ Metal Garden Fork					Art.no. 1070673	EAN 6 411501 705518
Height: 120,4cm	Length: 7,5cm	Width: 18,5cm	Weight: 1,7kg	Retail box: 4	Oldart.no. -	



- Ideal for aerating tough soil and turning compost.
- Boron steel head increases strength.
- D-shaped handle provides comfort and fits all hand sizes with or without gloves.

Solid™ Metal Compost Fork					Art.no. 1070674	EAN 6 411501 705525
Height: 126,2cm	Length: 10,1cm	Width: 22cm	Weight: 1,6kg	Retail box: 4	Oldart.no. -	



- Ideal for aerating soil and turning and spreading loose materials like grass, hay, weeds, leaves and other garden waste.
- Forged tines enhance strength in tough soil.
- D-shaped handle provides comfort.

FISKARS®

Happiness is planting deep roots

Landscaping tools
fiskars.com

QuikDrill™

Fiskars QuikDrill™ makes many garden tasks simpler, easier and more precise. It is a handy tool for planting flowers or bushes, or aerating and fertilizing the ground.

QuikDrill™ Garden Drill, S

Height: 111cm	Length: 10cm	Width: 51cm	Weight: 1,80kg	Retail box: 2	Art.no. 1000636	 EAN 5 905568 347107
					Old art.no. 134710	



- For planting bulbs, aerating and fertilizing soil and installing small posts.
- Drilling hole width 100 mm.

QuikDrill™ Garden Drill, M

Height: 111cm	Length: 15cm	Width: 51cm	Weight: 2,15kg	Retail box: 2	Art.no. 1000638	 EAN 5 905568 347206
					Old art.no. 134720	



- For perennial planting, aerating and mixing compost and installing medium sized posts.
- Drilling hole width 150 mm.

QuikDrill™ Garden Drill, L

Height: 111cm	Length: 20cm	Width: 51cm	Weight: 2,40kg	Retail box: 2	Art.no. 1000640	 EAN 5 905568 347305
					Old art.no. 134730	



- For planting hedges and trees, drilling compost holes and installing large posts.
- Drilling hole width 200 mm.

Classic Spades & Forks

Fiskars Classic tools are originals featuring timeless design and attention to detail. Better with time, after a few years, you start wondering how long you've had them because it feels like they have always been there.

Classic Pointed Spade FSC					Art.no. 1071935	EAN 6 411501 600486
Height: 106cm	Length: 8cm	Width: 19cm	Weight: 1,9kg	Retail box: 4	Old art.no. -	



- Features a sharpened steel blade for driving into tough soil.
- Spade head is made of boron steel for added strength.
- Head features depth measurements for precision and accuracy.
- Authentic wood shaft is FSC® certified.
- Comfortable D-shaped handle.

Classic Rounded Spade FSC					Art.no. 1071933	EAN 6 411501 600509
Height: 106cm	Length: 8cm	Width: 19cm	Weight: 1,9kg	Retail box: 4	Old art.no. -	



- Features a sharpened steel blade for edging and planting.
- Spade head is made of boron steel for added strength.
- Head features depth measurements for precision and accuracy.
- Authentic wood shaft is FSC® certified.
- Comfortable D-shaped handle.

Classic Rounded Spade Long Shaft FSC					Art.no. 1071931	EAN 6 411501 600523
Height: 112cm	Length: 9cm	Width: 19cm	Weight: 2kg	Retail box: 4	Old art.no. -	



- Features a sharpened steel blade for edging and planting.
- Spade head is made of boron steel for added strength.
- Head features depth measurements for precision and accuracy.
- Authentic wood shaft is FSC® certified.
- Comfortable D-shaped handle.

Classic Perennial Spade FSC					Art.no. 1071930	EAN 6 411501 600530
Height: 104cm	Length: 8cm	Width: 15cm	Weight: 2kg	Retail box: 4	Old art.no. -	



- Features a sharpened steel blade with a unique saw-blade edge for planting and dividing perennials.
- Spade head is made of boron steel for added strength.
- Head features depth measurements for precision and accuracy.
- Authentic wood shaft is FSC® certified.

Classic Garden Spade FSC					Art.no. 1071929	EAN 6 411501 600547
Height: 117cm	Length: 10cm	Width: 22cm	Weight: 1,8kg	Retail box: 4	Old art.no. -	



- Features a reinforced steel head.
- Spade head is made of boron steel for added strength.
- Authentic wood shaft is FSC® certified.
- Comfortable D-shaped handle.

Classic Pro Pointed Spade FSC					Art.no. 1071927	EAN 6 411501 600561
Height: 106cm	Length: 10cm	Width: 26cm	Weight: 2kg	Retail box: 4	Old art.no. -	



- The Frankfurt style wide and pointed spade head is made of boron steel for added strength.
- Authentic wood shaft is FSC® certified.
- Comfortable D-shaped handle.

Classic Shovel FSC					Art.no. 1071925	EAN 6 411501 600585
Height: 127cm	Length: 14cm	Width: 23cm	Weight: 2,1kg	Retail box: 4	Old art.no. -	



- Features a wide scoop that efficiently moves bulky materials.
- Shovel head is made of boron steel for added strength.
- Authentic wood shaft is FSC® certified.
- Comfortable T-shaped handle.

Classic Digging Shovel Lacquered FSC					Art.no. 1071924	EAN 6 411501 600592
Height: 127cm	Length: 14cm	Width: 23cm	Weight: 2,1kg	Retail box: 4	Old art.no. -	



- Features a wide scoop with a stepping board for digging into soft topsoil.
- Shovel head is made of boron steel for added strength.
- Authentic wood shaft is FSC® certified and lacquered for long-lasting value.

Classic Shovel Lacquered FSC					Art.no. 1071922	EAN 6 411501 600615
Height: 126cm	Length: 14cm	Width: 23cm	Weight: 2,1kg	Retail box: 4	Old art.no. -	



- Features a wide scoop that efficiently moves bulky materials like mulch and soil.
- Shovel head is made of boron steel for added strength.
- Authentic wood shaft is FSC® certified and lacquered for long-lasting value.
- Comfortable T-shaped handle.

Classic Drainage Spade FSC					Art.no. 1071921	EAN 6 411501 600622
Height: 112cm	Length: 9cm	Width: 16cm	Weight: 1,8kg	Retailbox: 4	Oldart.no. -	



- Features a sharpened blade for precise trenching.
- Shovel head is made of boron steel for added strength.
- Authentic wood shaft is FSC® certified.
- Comfortable D-shaped handle that fits hands of all sizes, with or without gloves.

Classic Pro Drainage Spade Long Blade FSC					Art.no. 1071920	EAN 6 411501 600639
Height: 138cm	Length: 10cm	Width: 20cm	Weight: 3,9kg	Retailbox: 2	Oldart.no. -	



- Features a sharpened blade for carving out trenches or ditches.
- Shovel head is made of boron steel for added strength.
- Authentic wood shaft is FSC® certified.
- Comfortable D-shaped handle.

Classic Pro Drainage Shovel FSC					Art.no. 1071919	EAN 6 411501 600646
Height: 129cm	Length: 14cm	Width: 14cm	Weight: 1,7kg	Retailbox: 4	Oldart.no. -	



- Features a narrow scoop that clears debris from drains and trenches.
- Shovel head is made of boron steel for added strength.
- Authentic wood shaft is FSC® certified.

Classic Pro Shovel I Handle FSC					Art.no. 1071918	EAN 6 411501 600653
Height: 145cm	Length: 14cm	Width: 23cm	Weight: 2,2kg	Retailbox: 4	Oldart.no. -	



- Features a wide scoop or moving piles of bulky materials like mulch, rock and soil.
- Shovel head is made of boron steel for added strength.
- Authentic wood shaft is FSC® certified.

Classic Pro Digging Shovel FSC					Art.no. 1071917	EAN 6 411501 600660
Height: 127cm	Length: 14cm	Width: 23cm	Weight: 2,1kg	Retailbox: 4	Oldart.no. -	



- Features a wide scoop with a stepping board for digging into bulky materials like mulch, rock and soil.
- Shovel head is made of boron steel for added strength.
- Authentic wood shaft is FSC® certified.

Classic Pro Building Shovel FSC					Art.no. 1071916	EAN 6 411501 600677
Height: 126cm	Length: 14cm	Width: 23cm	Weight: 2,1kg	Retailbox: 4	Oldart.no. -	



- Features a wide scoop perfect for moving piles of bulky materials like mulch, rock and soil.
- Shovel head is made of boron steel for added strength.
- Authentic wood shaft is FSC® certified.

Classic Pro Digging Spade Grey FSC					Art.no. 1071915	EAN 6 411501 600684
Height: 112cm	Length: 9cm	Width: 36cm	Weight: 2kg	Retailbox: 4	Oldart.no. -	



- Features a sharpened steel blade that drives into hard soil.
- Spade head is made of boron steel for added strength.
- Authentic wood shaft is FSC® certified.
- Comfortable D-shaped handle.

Classic Digging Fork FSC					Art.no. 1071914	EAN 6 411501 600691
Height: 116cm	Length: 9cm	Width: 18cm	Weight: 1,9kg	Retailbox: 4	Oldart.no. -	



- Ideal for digging, turning and loosening soil.
- Strong, narrow fork tines are made of boron steel for increased strength.
- Authentic wood shaft is FSC® certified.
- Comfortable D-shaped handle.

Classic Manure Fork FSC					Art.no. 1071912	EAN 6 411501 600714
Height: 125cm	Length: 11cm	Width: 26cm	Weight: 2kg	Retailbox: 4	Oldart.no. -	



- Ideal for moving and clearing manure and hay.
- Strong, narrow fork tines are made of boron steel for increased strength.
- Authentic wood shaft is FSC® certified.
- Comfortable D-shaped handle.

Classic Pro Lifting Fork FSC					Art.no. 1071911	EAN 6 411501 600721
Height: 138cm	Length: 14cm	Width: 32cm	Weight: 1,3kg	Retailbox: 4	Oldart.no. -	



- Ideal for lifting and moving straw and hay bales.
- Shovel head is made of boron steel for added strength.
- Authentic wood shaft is FSC® certified.
- Comfortable T-shaped handle.

Classic Potato Fork FSC

Height: **126 cm** Length: **17 cm** Width: **33 cm** Weight: **2,8 kg** Retail box: **2** Art.no. **1071889** Oldart.no. -

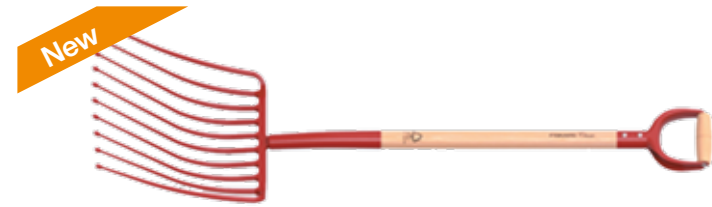

- Ideal for harvesting.
- Curved tines pick up and gently hold potatoes and other tubers.
- Fork head is made of boron steel for increased strength.
- Authentic wood shaft is FSC® certified.
- Comfortable D-shaped handle.

Classic Cultivweeder

Height: **169 cm** Length: **17 cm** Width: **12,5 cm** Weight: **0,93 kg** Retail box: **4** Art.no. **1003695** Oldart.no. **136700**



- Dual tool for cultivating, breaking up soil deep down and removing weeds before planting.
- FSC® certified wood.

Classic Hoe

Height: **140 cm** Length: **9 cm** Width: **16,5 cm** Weight: **1,23 kg** Retail box: **5** Art.no. **1014794** Oldart.no. **136770**



- Optimal for removing weeds between rows of plants or breaking up the soil surface.
- FSC® certified wood.

Classic Potato Hoe

Height: **124 cm** Length: **3,5 cm** Width: **20 cm** Weight: **1,23 kg** Retail box: **4** Art.no. **1003709** Oldart.no. **136750**



- Dig up potatoes and other vegetables without harming them.
- FSC® certified wood.

FISKARS®

Happiness is planting deep roots

Landscaping tools
fiskars.com

Cultivating Tools

Fiskars cultivating tools are designed for comfortable planting, cultivating, weeding and seeding. The three different ranges offer a wide selection of tools from weeders to rose rakes.

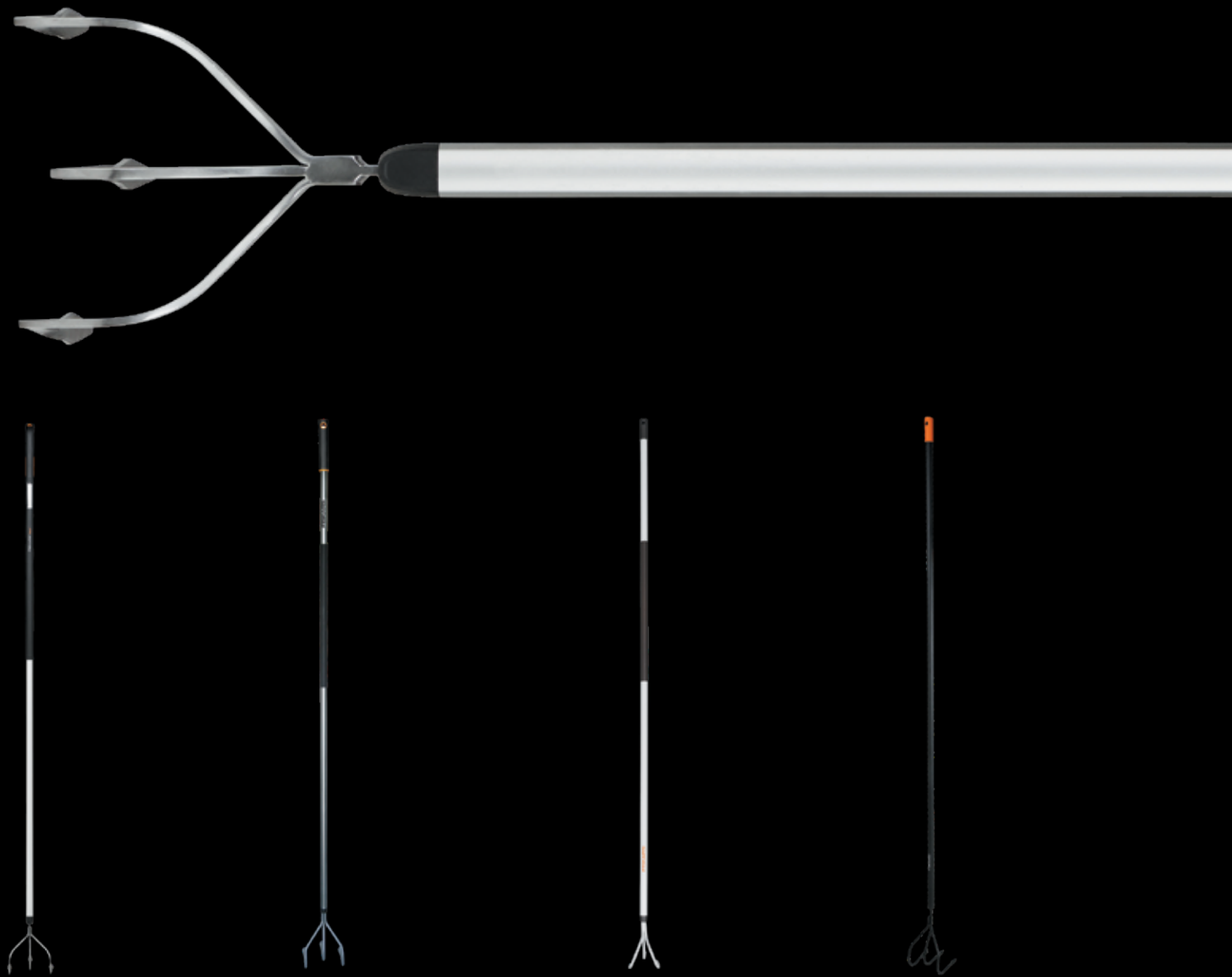

XACT™

Perfect tools covering all cultivating tasks with ultimate performance

EGRONOMIC™

Selected ergonomic tools for the most discerning gardener

WHITE

A beautiful, versatile range of light tools

SOLID™

All-purpose, basic garden tools

Xact™ Soil Care Tools

Xact™ 3-prong Cultivator, 150mm					Art.no. 1027040	EAN 6 411501 350855
Height: 172 cm	Length: 11,6 cm	Width: 14,8 cm	Weight: 0,88 kg	Retail box: 4	Old art.no. -	



- Well-designed, 3-prong cultivator for efficient loosening of compacted soil.
- Rigid, sturdy, stainless steel prongs penetrate soil precisely while tilling and cultivating.
- Hardened aluminium shaft with unique profile reduces weight without sacrificing strength for effortless strokes.
- SoftGrip™ handle allows for multiple hand positions, while its exceptional shape provides good support during use.
- Convenient hanging hole on handle for easy storage.

Xact™ Dutch Hoe, 125mm					Art.no. 1027041	EAN 6 411501 350862
Height: 170 cm	Length: 4 cm	Width: 12,4 cm	Weight: 0,80 kg	Retail box: 4	Old art.no. -	



- Quick and easy push motion efficiently uproots weeds just below the soil surface.
- Sharp stainless steel blades penetrate soil precisely while weeding and cultivating.
- Hardened aluminium shaft with unique profile reduces weight without sacrificing strength for effortless strokes.
- SoftGrip™ handle allows for multiple hand positions, while its exceptional shape provides good support during use.
- Convenient hanging hole on handle for easy storage.

Xact™ Push-Pull Weeder, 135mm					Art.no. 1027042	EAN 6 411501 350879
Height: 167,5 cm	Length: 11,6 cm	Width: 13,5 cm	Weight: 0,76 kg	Retail box: 4	Old art.no. -	



- Efficient, dual blade weeder weeds between plants or vegetables without damaging them.
- Mobile, stainless steel blade cuts through weeds on the pull and push stroke below the soil.
- Hardened aluminium shaft with unique profile reduces weight without sacrificing strength for effortless strokes.
- SoftGrip™ handle allows for multiple hand positions, while its exceptional shape provides good support during use.
- Convenient hanging hole on handle for easy storage.

Xact™ Weeding Knife, 30mm					Art.no. 1027112	EAN 6 411501 350886
Height: 173 cm	Length: 2,9 cm	Width: 9,5 cm	Weight: 0,73 kg	Retail box: 4	Old art.no. -	



- Dual blade weeding knife for removing weeds and moss between paving stones and patios.
- Precisely finished stainless steel blades provide ultimate performance and control.
- Hardened aluminium shaft with unique profile reduces weight without sacrificing strength for effortless strokes.
- SoftGrip™ handle allows for multiple hand positions, while its exceptional shape provides good support during use.
- Convenient hanging hole on handle for easy storage.

Ergonomic™ Soil Care Tools

Ergonomic™ Soil Rake					Art.no. 1000652	EAN 5 905568 800244
Height: 154 cm	Length: 7 cm	Width: 38 cm	Weight: 0,70 kg	Retail box: 4	Old art.no. 135510	



• Soil rake for preparing planting beds, smoothing down soil and other general gardening tasks like raking branches or spreading mulch.

Ergonomic™ Cultivator					Art.no. 1001301	EAN 7 317791 116661
Height: 167 cm	Length: 12,5 cm	Width: 12 cm	Weight: 0,79 kg	Retail box: 4	Old art.no. 136510	



• Cultivator for loosening and tilling soil before planting.

Ergonomic™ Hoe					Art.no. 1000675	EAN 7 317791 112601
Height: 155 cm	Length: 9 cm	Width: 20 cm	Weight: 0,53 kg	Retail box: 4	Old art.no. 136500	



• Hoe for removing weeds between rows of plants or breaking up the soil for cultivation.

Fiskars Ergonomic™

Beautifully designed and realised, Fiskars Ergonomic™ is a perfect selection of tools for cultivating, planting, digging, shovelling and composting – all for the most discerning gardener.

- Teardrop-shaped shaft enables ergonomic working positions
- Hanging hole for easy storage
- Plastic coating on shaft maximises grip and comfort
- Boron steel material for strength

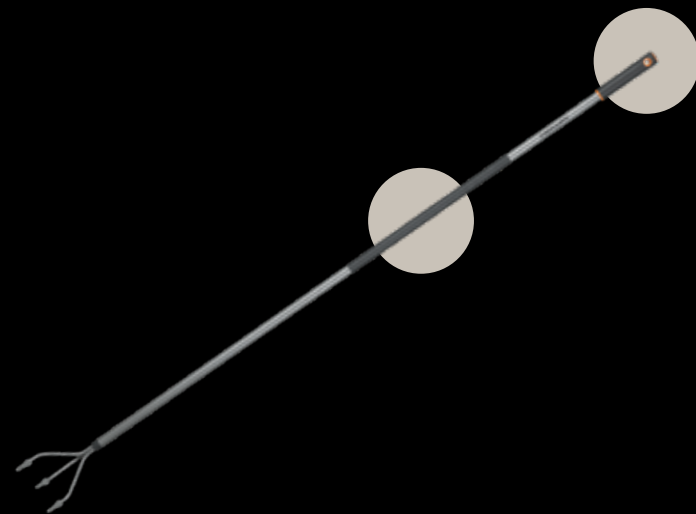

White Soil Care Tools

Weeding Knife, white					Art.no. 1019604	EAN 6 411501 365439
Height: 161 cm	Length: 3 cm	Width: 7,5 cm	Weight: 0,41 kg	Retail box: 4	Old art.no. 136543	



• Light weeding knife for removing weeds from patios or tight spaces in vegetable or flower beds.
• Steel head is shaped to fit easily into tight places.

Weeder, white					Art.no. 1019610	EAN 6 411501 365637
Height: 164,5 cm	Length: 4,5 cm	Width: 14,5 cm	Weight: 0,65 kg	Retail box: 4	Old art.no. 136563	



• Light weeder for removing weeds from vegetable beds and larger areas.
• Sharp steel blade to remove weeds.

Cultivator, white					Art.no. 1019611	EAN 6 411501 365736
Height: 164 cm	Length: 11 cm	Width: 9,5 cm	Weight: 0,55 kg	Retail box: 4	Old art.no. 136573	



• Light cultivator for loosening compacted soil.
• Sharp, hardened steel prongs penetrate soil easily when cultivating.

Hoe, white					Art.no. 1019609	EAN 6 411501 365538
Height: 158 cm	Length: 9 cm	Width: 19,5 cm	Weight: 0,48 kg	Retail box: 4	Old art.no. 136553	



• Light hoe for removing weeds and loosening soil in vegetable beds and under plants.
• Steel blade with sharp edges for reaching under plants.

Solid™ Soil Care Tools

Solid™ Cultivator					Art.no. 1016034	EAN 6 411501 357144
Height: 167 cm	Length: 12 cm	Width: 13 cm	Weight: 0,59 kg	Retail box: 4	Oldart.no. 135714	



- Easy-to-use tool for loosening and tilling soil before planting.
- Boron steel blade.
- Aluminium shaft.

Solid™ Hoe					Art.no. 1016035	EAN 6 411501 357137
Height: 164 cm	Length: 14 cm	Width: 16 cm	Weight: 0,52 kg	Retail box: 4	Oldart.no. 135713	



- Efficient tool for removing weeds between rows of plants or breaking up the soil for cultivation.
- Hardened carbon steel blade.

Solid™ Soil Rake					Art.no. 1016036	EAN 6 411501 357151
Height: 156,5 cm	Length: 7 cm	Width: 36 cm	Weight: 0,62 kg	Retail box: 4	Oldart.no. 135715	



- All-purpose soil rake for preparing planting beds, smoothing down soil and other general gardening tasks like raking branches or spreading mulch.
- Hardened carbon steel blade.
- Aluminium shaft.

FISKARS®

Happiness is planting deep roots

Landscaping tools
fiskars.com

Nursery Tools

Fiskars nursery tools are ergonomically designed with rounded edges to minimise soil and root damage while planting, cultivating, weeding and seeding.



XACT™ PLANTERS
Perfect tools covering all nursing tasks with ultimate performance

























PREMIUM PLANTERS
Ergonomically designed for comfortable planting

ERGO™ PLANTERS
Robust nursery tools for demanding cultivating tasks

WHITE PLANTERS
Lightweight and rust-free nursery tools

SOLID™ PLANTERS
Lightweight and rust-free nursery tools

Xact™ Hand Tools

Xact™ Trowel					Art.no. 1027043	EAN 
Height: 37,5cm	Length: 5cm	Width: 8,3cm	Weight: 0,28kg	Retail box: 4	Oldart.no. -	
			  		<ul style="list-style-type: none"> - Ideal for digging while planting, taking up plants and turning up soil. - Large stainless steel head with sharpened edges moves more soil, faster, while cutting easily through tough turf. - Comfortable SoftGrip™ handle allows for multiple handle positions, while its longer length brings balance and extra power when needed. - Convenient hanging hole on handle for easy storage. 	
Xact™ Hand Rake					Art.no. 1027044	EAN 
Height: 44,3cm	Length: 4cm	Width: 12,3cm	Weight: 0,20kg	Retail box: 4	Oldart.no. -	
			  		<ul style="list-style-type: none"> - Fan shaped hand rake is the perfect tool for raking up leaves, weeds and grass cuttings in small flowerbeds and hard-to-reach areas. - Perfectly finished stainless steel head with 7 prongs provide ultimate precision and control. - Comfortable SoftGrip™ handle allows for multiple handle positions, while its longer length brings balance and extra power when needed. - Convenient hanging hole on handle for easy storage. 	
Xact™ Small Weeding Knife					Art.no. 1027045	EAN 
Height: 33,8cm	Length: 3cm	Width: 9,4cm	Weight: 0,27kg	Retail box: 4	Oldart.no. -	
			  		<ul style="list-style-type: none"> - Dual blade weeding knife for removing weeds and moss between paving stones and patios. - Precisely finished stainless steel blades provide ultimate performance and control. - Comfortable SoftGrip™ handle allows for multiple handle positions, while its longer length brings balance and extra power when needed. - Convenient hanging hole on handle for easy storage. 	
Xact™ Extractor					Art.no. 1027046	EAN 
Height: 39,6cm	Length: 3,6cm	Width: 4,3cm	Weight: 0,26kg	Retail box: 4	Oldart.no. -	
			  		<ul style="list-style-type: none"> - Effective hand extractor for removing deep rooted weeds with minimal soil adhesion. - Long, sharp stainless steel blade provides precision and efficiency. - Comfortable SoftGrip™ handle allows for multiple handle positions, while its longer length brings balance and extra power when needed. - Convenient hanging hole on handle for easy storage. 	
Xact™ Cultivator					Art.no. 1027047	EAN 
Height: 32,3cm	Length: 6,2cm	Width: 9,2cm	Weight: 0,26kg	Retail box: 4	Oldart.no. -	
			  		<ul style="list-style-type: none"> - Durable and functional cultivator for loosening soil, removing weeds and aerating soil. - Large and sharp stainless steel tines provide maximum soil contact to speed work. - Comfortable SoftGrip™ handle allows for multiple handle positions, while its longer length brings balance and extra power when needed. - Convenient hanging hole on handle for easy storage. 	

Premium Planters™ Nursery Tools

Fiskars Premium Planters™ tools are constructed with added durability for repetitive tasks and heavy use in tough, hard ground.

Premium Planters™ Trowel					Art.no. 1000726	EAN 6 411501 372000
Height: 37,5cm	Length: 5,7cm	Width: 8,7cm	Weight: 0,13kg	Retail box: 4	Old art.no. 137200	



- For planting and transplanting in hard ground.
- Stainless steel blade.



Premium Planters™ Transplanter					Art.no. 1000727	EAN 6 411501 372109
Height: 27,5cm	Length: 4cm	Width: 7cm	Weight: 0,11kg	Retail box: 4	Old art.no. 137210	



- For planting and weeding in hard ground.
- Perfect for use in narrow bed layouts and on balconies.
- Stainless steel blade.



Premium Planters™ Cultivator					Art.no. 1000728	EAN 6 411501 372208
Height: 25cm	Length: 5cm	Width: 8cm	Weight: 0,14kg	Retail box: 4	Old art.no. 137220	



- For aerating and loosening soil in hard ground.
- Stainless steel blade.

Ergo™ Hand Tools

Ergo™ Trowel					Art.no. 1027017	EAN 6 411501 350718
Height: 30cm	Length: 2,5cm	Width: 7,5cm	Weight: 0,17kg	Retail box: 4	Old art.no. -	



- Ideal for digging in tough soil and breaking up hardened dirt clods.
- Lightweight, ergonomically shaped handle feels natural in your hand and helps reduce fatigue.
- Steel head won't break while digging in dense soil.
- Handle hang hole offers easy storage.

Ergo™ Transplanter					Art.no. 1027018	EAN 6 411501 350725
Height: 30cm	Length: 2,5cm	Width: 5,5cm	Weight: 0,14kg	Retail box: 4	Old art.no. -	



- Ideal for transplanting small plants and flowers.
- Lightweight, ergonomically shaped handle feels natural in your hand and helps reduce fatigue.
- Steel head won't break while digging in dense soil.
- Gradation marks on the blade make it easy to measure depth for perfect transplants.

Ergo™ Cultivator					Art.no. 1027019	EAN 6 411501 350732
Height: 30,5cm	Length: 4,5cm	Width: 8,5cm	Weight: 0,25kg	Retail box: 4	Old art.no. -	



- Ideal for digging in tough soil and breaking up hardened dirt clods.
- Lightweight, ergonomically shaped handle feels natural in your hand and helps reduce fatigue.
- Steel head won't break while digging in dense soil.
- Large tines provide maximum soil contact to speed up work.

Ergo™ Cultivator Hoe					Art.no. 1027030	EAN 6 411501 350749
Height: 30,5cm	Length: 7,5cm	Width: 18cm	Weight: 0,25kg	Retail box: 4	Old art.no. -	



- Ideal for loosening, aerating and shaping tough soil.
- Lightweight, ergonomically shaped handle feels natural in your hand and helps reduce fatigue.
- Sharpened hoe blade breaks up hard soil easily.
- Large cultivator tines provide maximum soil contact to speed work.
- Handle hang hole offers easy storage.

Ergo™ Weeding Knife					Art.no. 1027031	EAN 6 411501 350756
Height: 31cm	Length: 2,5cm	Width: 2,5cm	Weight: 0,13kg	Retail box: 4	Old art.no. -	



- Ideal for removing dandelions, thistles and other invasive plants.
- Lightweight, ergonomically shaped handle feels natural in your hand and helps reduce fatigue.
- Steel head won't break while digging in dense soil.
- Sharpened forked tip helps you remove weeds by the roots.

White Nursery Tools

Trowel, white					Art.no. 1027032	EAN 6 411501 350763
Height: 29,1cm	Length: 4,7cm	Width: 8,3cm	Weight: 0,08kg	Retailbox: 16	Oldart.no. -	



- Ideal for planting and transplanting.
- Lightweight, durable FiberComp™ material.
- Rustproof.
- Hang hole for easy storage.
- Can lift up to 35 kg.

Transplanter, white					Art.no. 1027033	EAN 6 411501 350770
Height: 29,1cm	Length: 4,2cm	Width: 5,8cm	Weight: 0,07kg	Retailbox: 16	Oldart.no. -	



- Ideal for planting and weeding.
- Perfect for use in narrow bed layouts and on balconies.
- Lightweight, durable FiberComp™ material.
- Rustproof.
- Hang hole for easy storage.
- Can lift up to 35 kg.

Fork, white					Art.no. 1027034	EAN 6 411501 350787
Height: 26,3cm	Length: 4cm	Width: 7,8cm	Weight: 0,09kg	Retailbox: 16	Oldart.no. -	



- Ideal for planting and weeding whilst protecting roots.
- Lightweight, durable FiberComp™ material.
- Rustproof.
- Hang hole for easy storage.
- Can lift up to 35 kg.

Cultivator Hoe, white					Art.no. 1027035	EAN 6 411501 350794
Height: 27,6cm	Length: 5cm	Width: 7,6cm	Weight: 0,09kg	Retailbox: 16	Oldart.no. -	



- Ideal for multiple planting and weeding tasks.
- Lightweight, durable FiberComp™ material.
- Rustproof.
- Hang hole for easy storage.
- Can lift up to 35 kg.

Solid™ Nursery Tools

Solid™ Planters Trowel					Art.no. 1071899	EAN 6 411501 705754
Height: 28,2cm	Length: 4,9cm	Width: 8cm	Weight: 0,08kg	Retailbox: 16	Oldart.no. 1000694	



- * Made from 65% recycled plastic with fiberglass for durability.
- Ideal for breaking up soil and digging small holes in planters and garden beds.
- UV resistant.
- Convenient hang hole offers easy storage options.

Solid™ Planters Transplanter					Art.no. 1072101	EAN 6 411501 705778
Height: 28,2cm	Length: 4,5cm	Width: 6cm	Weight: 0,07kg	Retailbox: 16	Oldart.no. 1000695	



- * Made from 65% recycled plastic with fiberglass for durability.
- Ideal for transplanting small plants in tight spaces.
- UV resistant.
- Convenient hang hole offers easy storage options.

Solid™ Planters Cultivator					Art.no. 1072102	EAN 6 411501 705785
Height: 27,4cm	Length: 8,1cm	Width: 8,2cm	Weight: 0,08kg	Retailbox: 16	Oldart.no. 1001600	



- * Made from 65% recycled plastic with fiberglass for durability.
- Wide tines are angled to loosen compact soil and remove weeds in garden beds.
- UV resistant.
- Convenient hang hole offers easy storage options.

Solid™ Planters Weed Fork					Art.no. 1072103	EAN 6 411501 705792
Height: 27,7cm	Length: 4,5cm	Width: 8,2cm	Weight: 0,07kg	Retailbox: 16	Oldart.no. 1000696	



- * Made from 65% recycled plastic with fiberglass for durability.
- Narrow, curved tines aerate soil, remove rocks and weeds and spread compost over small areas.
- UV resistant.
- Convenient hang hole offers easy storage options.

Solid™ Planters Hoe					Art.no. 1072100	EAN 6 411501 705761
Height: 28,2cm	Length: 18,9cm	Width: 7,4cm	Weight: 0,12kg	Retailbox: 12	Oldart.no. 1001601	



- * Made from 65% recycled plastic with fiberglass for durability.
- Wide, flat edge for digging seed furrows or chopping up tough roots.
- Forked edge for aerating soil and removing weeds and rocks.
- UV resistant.
- Convenient hang hole offers easy storage options.

Yard Cleaning



Patio & Yard Brooms

Fiskars offers a range of brooms that make light work of outdoor yard and garden clearing, including front doors, sidewalks, driveways, garages, stairs, wooden decks and more.

Our brooms' ingeniously-designed heads combine attractive design with functionality and durability.

Features & benefits

1 Easy storage

Functional grip knob offers a comfortable grip & easy storage solution

2 Durable materials & construction

Perfect selection of durable, weather tolerant materials suitable for outdoor use

3 Efficient & effortless to use

Optimal combination of bristles for efficient sweeping of different surfaces. The light weight aluminium handles ensures that sweeping can be undertaken without fatigue or back ache.

4 Modern functional design

Purposefully designed broom heads that reach & sweep even the tightest spots. The brooms have an aesthetic design that is pleasant to have by your front door.

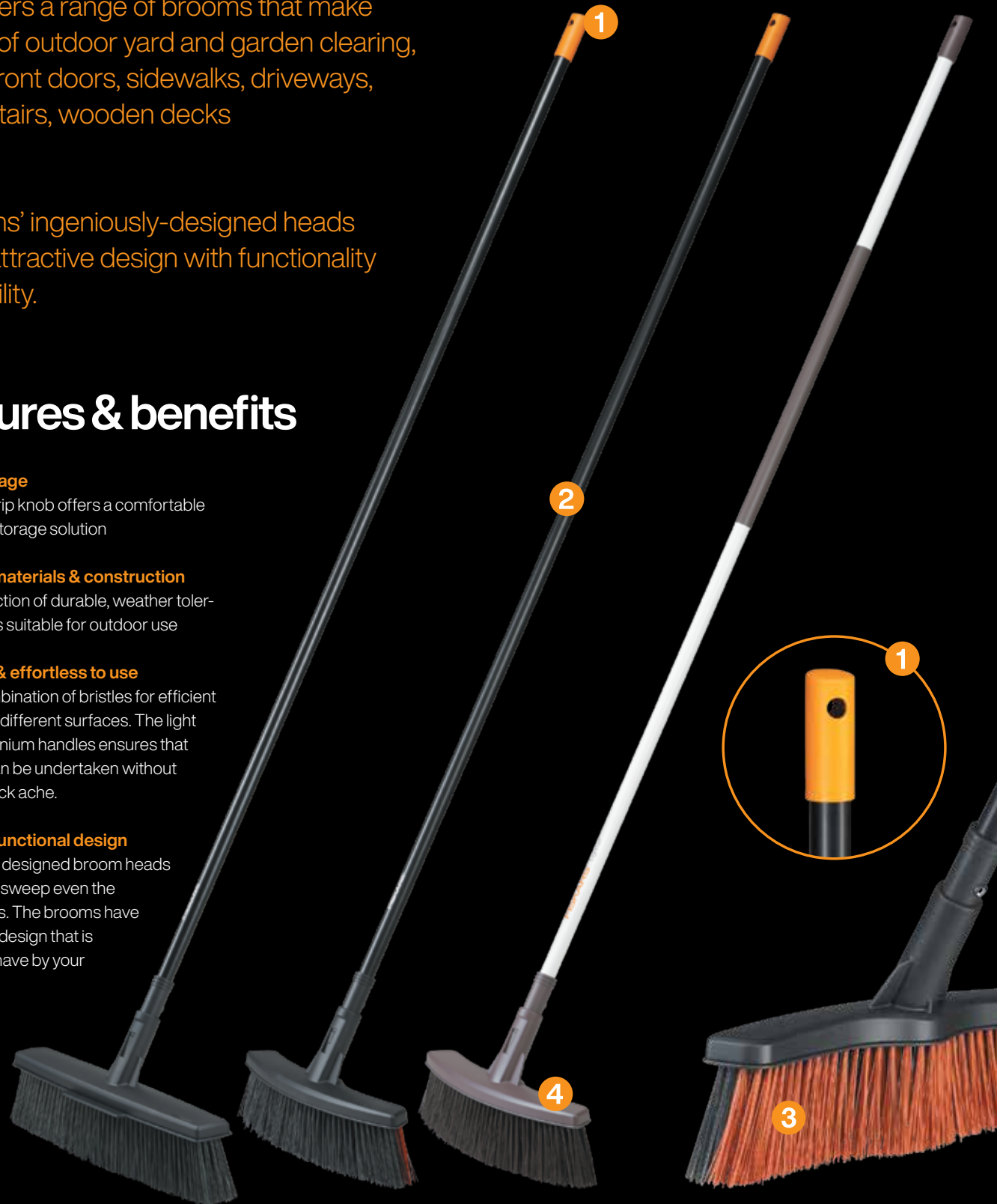

Light Broom

Patio Broom, white

Height: 162 cm Length: 12,5 cm Width: 43,5 cm Weight: 0,63 kg Retail box: 4

Art.no. 1025927

Oldart.no. -



- Patio broom for sweeping smoother surfaces like patios, wooden decks, balconies & terraces.
- Perfect for cleaning of smaller particles.
- Offers a clean sweep of all garden leaves and debris.
- The ends of the broom curve inwards, making it ideal for cleanly gathering and sweeping garden leaves and debris.
- SoftGrip™ handle for a comfortable, secure grip.
- Lightweight for improved ergonomics.
- Modern functional design.

Solid™ All Purpose Yard Brooms

Solid™ All Purpose Yard Broom, M

Height: 169 cm Length: 10 cm Width: 38 cm Weight: 0,63 kg Retail box: 4

Art.no. 1025921

Oldart.no. -

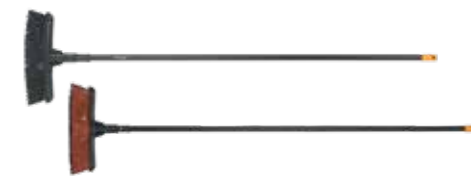

- All-purpose yard broom for cleaning pavements, patios and other yard areas.
- Offers a clean sweep of all garden leaves and debris.
- The ends of the broom curve inwards, making it ideal for cleanly gathering and sweeping garden leaves and debris.
- PowerClean™ combines soft and hard bristles for efficient sweeping.
- Modern, functional, lightweight design for better ergonomics.

Solid™ All Purpose Yard Broom, L

Height: 172 cm Length: 12,5 cm Width: 48 cm Weight: 0,87 kg Retail box: 2

Art.no. 1025926

Oldart.no. -



- All-purpose yard broom for cleaning pavements, patios and other large areas like driveways and garages.
- Cleanly sweeps garden leaves and debris, while featuring a scraping edge for stubborn dirt.
- PowerClean™ combines soft and hard bristles for efficient sweeping.
- Modern, functional, lightweight design for better ergonomics.

Solid™ All Purpose Yard Broom Head, M

Height: 20 cm Length: 37,5 cm Width: 10,5 cm Weight: 0,39 kg Retail box: 6

Art.no. 1025930

Oldart.no. -



- All-purpose yard broom for cleaning pavements, patios and other yard areas.
- Offers a clean sweep of all garden leaves and debris.
- The ends of the broom curve inwards, making it ideal for cleanly gathering and sweeping garden leaves and debris.
- PowerClean™ combines soft and hard bristles for efficient sweeping.
- Modern, functional, lightweight design for better ergonomics.
- Use with Solid™ Shaft (1014913).
- Spare part for Solid™ All purpose broom, M (1025921).

Solid™ All Purpose Yard Broom Head, L

Height: **20 cm** Length: **47 cm** Width: **10,5 cm** Weight: **0,57 kg** Retail box: **4**

Art.no. **1025931**



- All-purpose yard broom for clearing pavements, patios and other large areas like driveways and garages.
- Cleanly sweeps garden leaves and debris, while featuring a scraping edge for stubborn dirt.
- PowerClean™ combines soft and hard bristles for efficient sweeping.
- Modern, functional, lightweight design for better ergonomics.
- Use with Solid™ Shaft (1014913).
- Spare part to Solid™ All purpose yard broom, L (1025926).

Solid™ Shaft

Height: **157,5 cm** Length: **3 cm** Width: **2,8 cm** Weight: **0,31 kg** Retail box: **10**

Art.no. **1014913**



- Lightweight, durable aluminium construction.
- Compatible with Solid™ Broom heads (article No 1025930 & 1025931).

FISKARS

Rake it.
Gather it.
Tidy it.

fiskars.com

Kids Tools



MyFirst Fiskars Kids Tools

MyFirst Fiskars Shovel					Art.no. 1001421	EAN 6 411501 381804
Height: 88,1cm	Length: 10,7cm	Width: 19cm	Weight: 0,28kg	Retail box: 5	Oldart.no. 138180	

reddot design award winner 2013

SGS TÜV SAAR GS FENNIAPRIZE 14 HONORARY MENTION

• Fibre reinforced plastic scoop for maximum functionality and long-term durability.

MyFirst Fiskars Spade					Art.no. 1001420	EAN 6 411501 381705
Height: 91cm	Length: 4,5cm	Width: 16,8cm	Weight: 0,23kg	Retail box: 5	Oldart.no. 138170	

reddot design award winner 2013

SGS TÜV SAAR GS FENNIAPRIZE 14 HONORARY MENTION

• Fibre-reinforced plastic scoop for maximum functionality and long-term durability.

MyFirst Fiskars Rake					Art.no. 1001419	EAN 6 411501 381606
Height: 86,8cm	Length: 3,9cm	Width: 19cm	Weight: 0,17kg	Retail box: 5	Oldart.no. 138160	

reddot design award winner 2013

SGS TÜV SAAR GS FENNIAPRIZE 14 HONORARY MENTION

• Flexible plastic tines for maximum functionality and long term durability.

MyFirst Fiskars Broom					Art.no. 1001418	EAN 6 411501 381507
Height: 80,3cm	Length: 6,8cm	Width: 19,8cm	Weight: 0,32kg	Retail box: 5	Oldart.no. 138150	

reddot design award winner 2013

SGS TÜV SAAR GS FENNIAPRIZE 14 HONORARY MENTION

• Thick, but soft plastic bristles for maximum comfort, functionality and long-term durability.

MyFirst Fiskars Trowel + Cultivator Set					Art.no. 1062471	EAN 6 411501 704214
Height: 24 cm	Length: 3,4 cm	Width: 7 cm	Weight: 0,22 kg	Retail box: 24	Oldart.no. -	



- Long handles allow for multiple grips.
- Made of fibre-reinforced materials for durability.

MyFirst Fiskars 4pc Short-handled Set					Art.no. 1062472	EAN 6 411501 704221
Height: 33,3 cm	Length: 5,7 cm	Width: 22,86 cm	Weight: 1 kg	Retail box: 18	Oldart.no. -	



- Quality, lightweight tools are right-sized for kids' hands.

MyFirst Fiskars Essentials Set					Art.no. 1062473	EAN 6 411501 704238
Height: 88,1 cm	Length: 10,7 cm	Width: 19 cm	Weight: 0,39 kg	Retail box: 4	Oldart.no. -	



- Lightweight, yet strong, aluminium handles resist rust.
- Durable, fibre-reinforced plastic heads.

MyFirst Fiskars Clean-up Set					Art.no. 1062474	EAN 6 411501 704245
Height: 86,3 cm	Length: 6,8 cm	Width: 19,8 cm	Weight: 0,48 kg	Retail box: 4	Oldart.no. -	



- Lightweight, yet strong, aluminium handles resist rust.
- Durable, fibre-reinforced plastic heads.
- Broom features strong, flexible bristles for effective sweeping.



Designed for
small hands and
big imaginations

Fiskars QuikFit™



Click & Reach [p.135](#)

Click & Clean [p.137](#)

Click & Grow [p.140](#)

Smart and safe

Featuring interchangeable heads and handles, Fiskars QuikFit™ offers safe, smart, neat and transportable solutions for all your garden tasks.

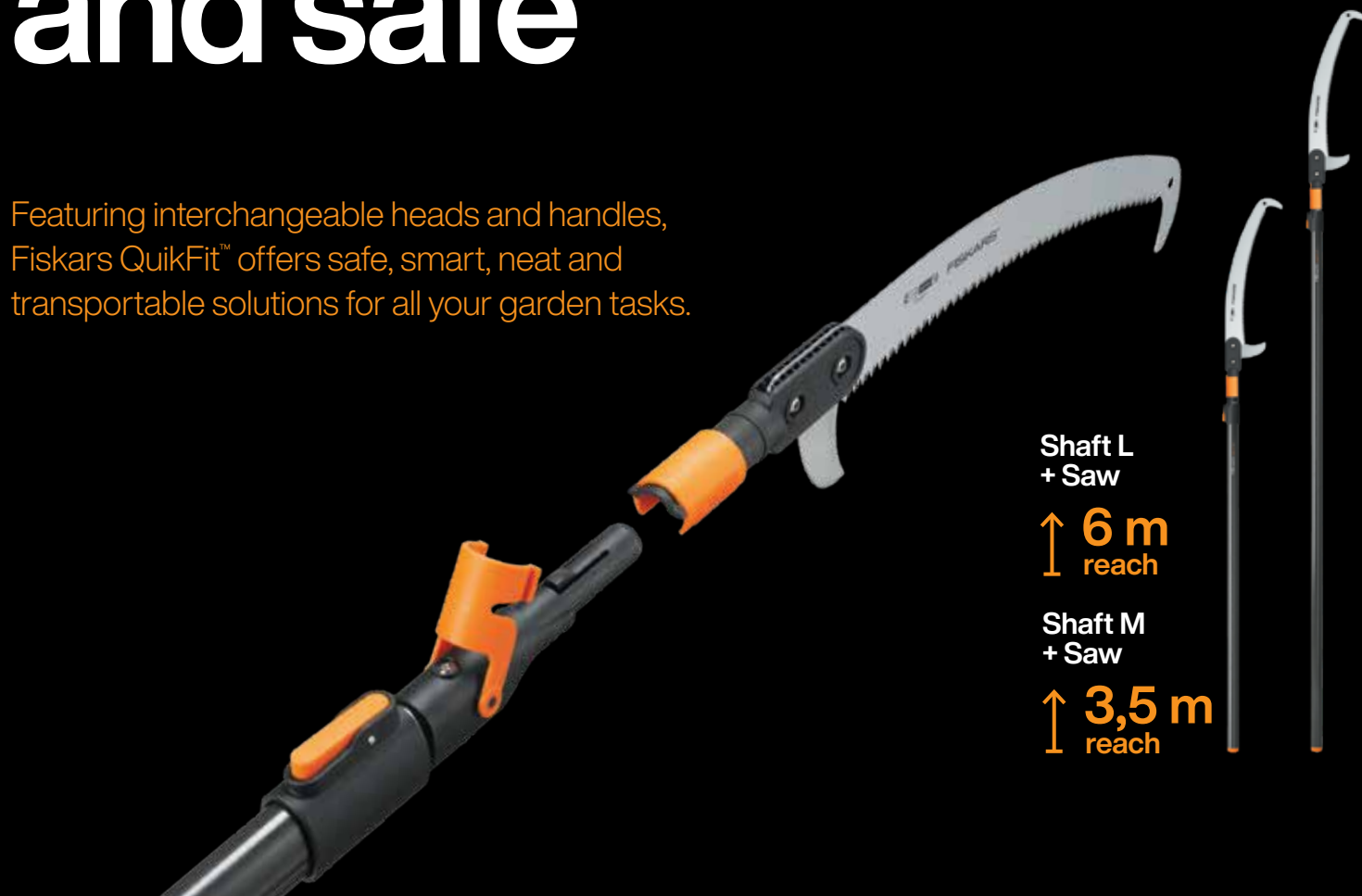

reddot design award winner 2010

Shaft L + Saw

↑ 6 m reach

Shaft M + Saw

↑ 3,5 m reach



Click & Reach

Within the Click & Reach range, QuikFit™ offers easy solutions for those hard-to-reach tasks, paying special attention to safety. Forget the ladder when sawing high branches or cleaning gutters – let QuikFit™ do the job from the ground up.

Click & Clean

Within the Click & Clean range, QuikFit™ offers easy solutions for cleaning your lawn and yard, with special attention paid to functionality and storage efficiency. With their unique and smart design, QuikFit™ rakes and brooms allow you to tidy up your garden with minimal effort, all while keeping your shed neat and clutter-free.

Click & Grow

Within the Click & Grow range, QuikFit™ offers easy and mobile solutions for cultivating vegetables and flowers in your garden, summer cottage or city allotment. The unique space-saving system, where one shaft can be used with several tool heads, makes transportation and storage easy.

QuikFit™ Click & Reach



reddot design award winner 2010

QuikFit™ Tree Cutter

Height: 44 cm Length: 7,5 cm Width: 12,5 cm Weight: 0,57 kg Retail box: 6

Art.no. 1001410

Old art.no. 136525



- Enhanced cutting power (x12) with PowerReel™ mechanism.
- No external ropes on the cutting head allows you to easily reach any branch.
- Anvil cutting action for dry and hard wood.
- Cut capacity: Ø 32 mm.

Recommended Shaft: Telescopic Shaft L and Telescopic Shaft M.

QuikFit™ Curved Saw

Height: 65 cm Length: 6 cm Width: 14 cm Weight: 0,32 kg Retail box: 6

Art.no. 1000691

Old art.no. 136527



- Pull saw with hardened steel blade with a length of 360 mm.
- Top-hook ensures non-slip steadiness while pulling.
- Bottom knife ensures a clean and precise finishing cut from below the branch.

Recommended Shaft: Telescopic Shaft L and Telescopic Shaft M.

QuikFit™ Fruit Picker

Height: 41 cm Length: 8,5 cm Width: 16,8 cm Weight: 0,23 kg Retail box: 6

Art.no. 1000693

Old art.no. 136950



- NEW Product design updated in 2022.
- Broad opening makes it easy to pull fruit off the branch, while an optimal design directs the fruit to the end of the tips.
- Machine washable, mesh bag catches the harvest, allowing you to see your yield.
- Durable, lightweight FiberComp™ design.

Recommended Shaft: Telescopic Shaft L, Telescopic Shaft M and Shaft L.

QuikFit™ Gutter Cleaner

Height: 26 cm Length: 7 cm Width: 34 cm Weight: 0,34 kg Retail box: 6

Art.no. 1001414

Old art.no. 135542



- Brush and scraper combination offers a full complement of gutter cleaning capabilities.
- Adjustable angle ensures optimal positioning of tool safely from the ground.

Recommended Shaft: Telescopic Shaft L and Telescopic Shaft M.

QuikFit™ Telescopic Shaft, M

Height: 140 cm Length: 4,5 cm Width: 7,5 cm Weight: 1,01 kg Retail box: 6

Art.no. 1000666

Old art.no. 136042



- Specially designed for hard-to-reach tasks in the garden with a reach of up to 4 metres.
- Fits conveniently into most cars.
- Dual locking system for maximum safety.
- Lightweight aluminium construction.
- Adjustable shaft length from 1400 - 2400 mm.

QuikFit™ Click & Reach



QuikFit™ Telescopic Shaft, L					Art.no. 1000665	EAN 
Height: 228,5cm	Length: 4cm	Width: 9,5cm	Weight: 1,55kg	Retailbox: 4	Oldart.no. 136032	

- Especially designed for hard to reach tasks in the garden with a reach of up to 6 m.
- Dual locking system for maximum safety.
- Lightweight aluminium construction.
- Adjustable shaft length from 2280 - 4000 mm.



QuikFit™ Click & Clean



QuikFit™ Leaf Rake, L					Art.no. 1000642	EAN 
Height: 41,5cm	Length: 6cm	Width: 51cm	Weight: 0,32kg	Retailbox: 6	Oldart.no. 135013	

- Wide rake for gathering fallen leaves and grass cuttings.
- Tines work in a pull direction for more comfort with less effort.
- 25 soft and flexible, high-quality PBT plastic tines withstand bending.

Recommended Shaft: Shaft L.



QuikFit™ Leaf Rake Metal					Art.no. 1000644	EAN 
Height: 59cm	Length: 7,5cm	Width: 45cm	Weight: 0,50kg	Retailbox: 6	Oldart.no. 135201	

- For removing loose moss and grass cuttings from the lawn.
- 22 flexible steel prongs.

Recommended Shaft: Shaft L.



QuikFit™ Gather Rake					Art.no. 1000656	EAN 
Height: 26cm	Length: 12cm	Width: 56,7cm	Weight: 0,93kg	Retailbox: 2	Oldart.no. 135514	

- Wide rake for gathering leaves and cutting waste from lawn areas.
- Hardened carbon steel head.

Recommended Shaft: Shaft L.



QuikFit™ Aerator Rake					Art.no. 1000655	EAN 
Height: 36cm	Length: 8,2cm	Width: 35,5cm	Weight: 0,99kg	Retailbox: 2	Oldart.no. 135513	

- For removing moss and thatch from lawn areas.
- Hardened carbon steel head.

Recommended Shaft: Shaft L.



QuikFit™ Leaf Rake, S					Art.no. 1000659	EAN 
Height: 41cm	Length: 4,2cm	Width: 22cm	Weight: 0,17kg	Retailbox: 6	Oldart.no. 135551	

- Convenient small leaf rake for clearing around narrow beds and borders.
- Tines work in a pull direction for more comfort with less effort.
- 11 soft and flexible, high-quality PBT plastic tines withstand bending.

Recommended shaft: Shaft M and L.





QuikFit™ Flower Rake					Art.no. 1001412	EAN 6 4 1 1 5 0 1 3 5 5 5 2 2
Height: 48,5 cm	Length: 4 cm	Width: 12,5 cm	Weight: 0,22 kg	Retail box: 6	Oldart.no. 135552	



- Durable FiberComp™ frame with 7 steel tines.
- 13 cm working width - ideal for nursery spaces and narrow plant beds.

Recommended shaft: Handle S and Shaft M.

QuikFit™ Lawn Edger					Art.no. 1000690	EAN 5 9 0 5 5 6 8 5 4 0 4 5 4
Height: 35 cm	Length: 4 cm	Width: 19,7 cm	Weight: 0,30 kg	Retail box: 6	Oldart.no. 136526	



- Easily clear space between your lawn and hard surfaces by stepping on the blade and driving it deep into the soil.
- Great for edging borders.
- Hardened boron steel head with flat top.

Recommended shaft: Shaft M and L.

QuikFit™ Yard Broom					Art.no. 1001417	EAN 5 9 0 5 5 6 8 3 5 5 3 2 4
Height: 29 cm	Length: 10 cm	Width: 26 cm	Weight: 0,33 kg	Retail box: 6	Oldart.no. 135532	



- All-purpose yard broom.
- Featuring PowerClean™ soft and hard combing bristles for efficient sweeping.

Recommended shaft: Shaft M and L.

QuikFit™ Patio Broom					Art.no. 1001416	EAN 5 9 0 5 5 6 8 3 5 5 3 3 1
Height: 31 cm	Length: 9,5 cm	Width: 38 cm	Weight: 0,34 kg	Retail box: 6	Oldart.no. 135533	



- For sweeping smooth surfaces like patios, wooden decks and polished concrete floors.
- Wide brush head and soft bristles allow for fast, efficient sweeping.

Recommended shaft: Shaft M and L.

QuikFit™ Sweeping Broom					Art.no. 1001415	EAN 5 9 0 5 5 6 8 3 5 5 3 4 8
Height: 39,5 cm	Length: 7 cm	Width: 26 cm	Weight: 0,39 kg	Retail box: 6	Oldart.no. 135534	



- A modern take on the traditional sweeping broom.
- Robust construction and long bristles make it ideal for use on coarser debris, leaves, etc..

Recommended shaft: Shaft M and L.



QuikFit™ Paving Brush					Art.no. 1000657	EAN 5 9 0 5 5 6 8 3 5 5 2 2 5
Height: 32,5 cm	Length: 4,5 cm	Width: 14,5 cm	Weight: 0,19 kg	Retail box: 6	Oldart.no. 135522	



- For removing moss and weeds from between paving slabs.
- Hardened steel front blade for stubborn moss and dirt.
- Steel bristles for scrubbing paving and slabs.
- Lightweight FiberComp™ construction for added durability and resistance to moisture.

Recommended shaft: Shaft M and L.

QuikFit™ Patio Knife					Art.no. 1000687	EAN 5 9 0 5 5 6 8 5 4 0 3 9 3
Height: 33,5 cm	Length: 7 cm	Width: 7,5 cm	Weight: 0,16 kg	Retail box: 6	Oldart.no. 136521	



- Ideal tool for removing grass, moss and weeds from between slabs, block paving, wall corners and steps.
- Blade of hardened boron steel.

Recommended shaft: Shaft M and L.

QuikFit™ Straight Saw					Art.no. 1000692	EAN 5 9 0 5 5 6 8 3 6 5 2 8 6
Height: 62 cm	Length: 10 cm	Width: 10 cm	Weight: 0,20 kg	Retail box: 6	Oldart.no. 136528	



- For sawing tasks in the garden.
- FiberComp™ slider and adaptor.
- Hardened steel blade with a length of 345 mm.

Recommended shaft: Shaft M and L.

QuikFit™ Click & Grow



QuikFit™ Soil Rake, 14 prongs					Art.no. 1000653	EAN 
Height: 27 cm	Length: 9 cm	Width: 38 cm	Weight: 0,44 kg	Retail box: 6	Oldart.no. 135511	



- For raking, leveling or smoothing seed beds that cover a wider area.
 - 14 spikes of hardened carbon steel.
- Recommended shaft: Shaft L.

QuikFit™ Soil Rake, 16 prongs					Art.no. 1000654	EAN 
Height: 26,5 cm	Length: 8 cm	Width: 61,4 cm	Weight: 0,45 kg	Retail box: 6	Oldart.no. 135512	



- For raking, leveling or smoothing seed beds that cover a wider area.
 - 16 tines of hardened carbon steel.
- Recommended shaft: Shaft L.

QuikFit™ Universal Rake					Art.no. 1000643	EAN 
Height: 26 cm	Length: 11 cm	Width: 41 cm	Weight: 0,28 kg	Retail box: 6	Oldart.no. 135051	



- For raking and clearing long, loose grass, as well as leveling soil and sand or packing down soil while making planting beds.
 - 12 FiberComp™ tines designed at a specific angle to help with ergonomic posture.
 - Leveling function helps even soil beds.
- Recommended shaft: Shaft L.

QuikFit™ Rose Rake					Art.no. 1000651	EAN 
Height: 29,5 cm	Length: 7,5 cm	Width: 24,3 cm	Weight: 0,22 kg	Retail box: 6	Oldart.no. 135501	



- Unique head shape allows you to work between plants and stems without causing damage.
 - Ideal for narrow bed layouts.
 - 10 teeth of hardened boron steel.
- Recommended shaft: Shaft L and M.

QuikFit™ Cultivator					Art.no. 1000680	EAN 
Height: 40 cm	Length: 12 cm	Width: 12 cm	Weight: 0,40 kg	Retail box: 6	Oldart.no. 136511	



- For cultivating, scarifying, aerating and breaking up soil.
 - Suitable for seed bed preparation and maintenance.
 - Hardened carbon steel blade.
- Recommended shaft: Shaft L.



QuikFit™ Cultiveeder					Art.no. 1000681	EAN 
Height: 41,5 cm	Length: 17,5 cm	Width: 12,5 cm	Weight: 0,51 kg	Retail box: 6	Oldart.no. 136512	



- For cultivating, scarifying, aerating and breaking up soil.
 - Suitable for seed bed preparation and maintenance.
 - Hardened carbon steel blade.
- Recommended shaft: Shaft L.

QuikFit™ Grubber					Art.no. 1000685	EAN 
Height: 36,5 cm	Length: 10 cm	Width: 9 cm	Weight: 0,36 kg	Retail box: 6	Oldart.no. 136517	



- For cultivating and aerating garden flower beds.
 - Hardened carbon steel blade.
- Recommended shaft: Shaft M and L.

QuikFit™ Hoe					Art.no. 1000677	EAN 
Height: 32,5 cm	Length: 9,5 cm	Width: 19,5 cm	Weight: 0,27 kg	Retail box: 6	Oldart.no. 136503	



- Efficient tool for removing weeds between rows of plants or breaking up the soil.
 - Blade of stainless steel.
- Recommended shaft: Shaft L.

QuikFit™ Push-Pull Weeder					Art.no. 1000738	EAN 
Height: 37,5 cm	Length: 4,5 cm	Width: 15,5 cm	Weight: 0,39 kg	Retail box: 6	Oldart.no. 139970	



- Useful for weeding as it loosens the soil simply by pushing and pulling back and forth.
 - Hardened boron steel head.
- Recommended shaft: Shaft L.

QuikFit™ Hoe, 3 functions					Art.no. 1000682	EAN 
Height: 42 cm	Length: 4 cm	Width: 13 cm	Weight: 0,27 kg	Retail box: 6	Oldart.no. 136513	



- For working around stems and in narrow spaces.
 - Blade is sharpened on 3 sides to assist cultivating at different angles.
 - Blade of hardened boron steel.
- Recommended shaft: Shaft L.



QuikFit™ Dutch Hoe					Art.no. 1000676	EAN 5 905568 540362
Height: 38,5cm	Length: 4cm	Width: 12,5cm	Weight: 0,23kg	Retail box: 6	Oldart.no. 136502	



- Sharp, ground weeding blade for removing weeds, breaking up soil, creating seed rows or removing moss from patios.
- Blade of hardened boron steel.

Recommended shaft: Shaft L.

QuikFit™ Spiker					Art.no. 1000689	EAN 6 411501 365248
Height: 39,5cm	Length: 10cm	Width: 20,5cm	Weight: 0,91kg	Retail box: 2	Oldart.no. 136524	



- Used for aerating smaller, narrower plots.
- Allows nutrients to penetrate the surface and helps seed, fertiliser, water, air and light to reach the roots.
- Hardened steel blades.

Recommended shaft: Shaft L.

QuikFit™ Cultivator, Angled					Art.no. 1000683	EAN 5 905568 365156
Height: 40,5cm	Length: 8cm	Width: 9cm	Weight: 0,34kg	Retail box: 6	Oldart.no. 136515	



- For loosening and aerating plant beds to optimise nutrient distribution.
- Tool design protects plants roots.
- Carbon steel head.

Recommended shaft: Handle S and Shaft M.

QuikFit™ Double Scraper Hoe					Art.no. 1000734	EAN 5 905568 375629
Height: 28,2cm	Length: 14,7cm	Width: 7,5cm	Weight: 0,20kg	Retail box: 6	Oldart.no. 137562	



- Versatile use on patios and for removing grass, moss and weeds from between tiles and slabs.
- Can also be used to cultivate plant beds.
- Boron steel blades with carbon steel thong.

Recommended shaft: Handle S and Shaft M.

QuikFit™ Double Hoe					Art.no. 1000735	EAN 5 905568 375728
Height: 28,2cm	Length: 14,3cm	Width: 7,5cm	Weight: 0,19kg	Retail box: 6	Oldart.no. 137572	



- Versatile use with dual functionality.
- For breaking up soil, cultivating plant beds and weeding.
- Boron steel blades with carbon steel thong.

Recommended shaft: Handle S and Shaft M.



QuikFit™ Trowel					Art.no. 1000730	EAN 5 905568 375124
Height: 41cm	Length: 5,5cm	Width: 7,5cm	Weight: 0,29kg	Retail box: 6	Oldart.no. 137512	



- For planting and transplanting.
- Boron steel head.

Recommended shaft: Handle S and Shaft M.

QuikFit™ Weed Extractor					Art.no. 1000731	EAN 5 905568 375223
Height: 42,5cm	Length: 4cm	Width: 7,5cm	Weight: 0,23kg	Retail box: 6	Oldart.no. 137522	



- For planting and transplanting.
- Boron steel head.

Recommended shaft: Handle S and Shaft M.

QuikFit™ Shaft, L					Art.no. 1000661	EAN 5 905568 540461
Height: 157cm	Length: 3,5cm	Width: 7,5cm	Weight: 0,49kg	Retail box: 6	Oldart.no. 136001	



- Teardrop-shaped, hardened aluminium shaft with SoftGrip™ for optimum comfort.
- Hang hole for easy storage.
- Shaft works with several heads for all-around use in the garden.

QuikFit™ Shaft, M					Art.no. 1000664	EAN 5 905568 360229
Height: 87,5cm	Length: 4cm	Width: 7,5cm	Weight: 0,31kg	Retail box: 6	Oldart.no. 136022	



- Medium-length shaft can be used with nursery tools, cultivators and hoes.
- Teardrop-shaped, hardened aluminium shaft with SoftGrip™ for optimum comfort.
- Hang hole for easy storage.
- Shaft works with several heads for all-around use in the garden.

QuikFit™ Handle, S					Art.no. 1000663	EAN 5 905568 360120
Height: 25,5cm	Length: 4,5cm	Width: 8cm	Weight: 0,11kg	Retail box: 6	Oldart.no. 136012	



- Small handle ideal for use with nursery tools.
- Teardrop-shaped, hardened aluminium shaft with SoftGrip™ for optimum comfort.
- Hang hole for easy storage.
- Shaft works with several heads for all-around use in the garden.



reddot design award
winner 2010

QuikFit™ Universal Adapter

Height: 17,1cm Length: 4,3cm Width: 3cm Weight: 0,07kg Retailbox: 6

Art.no. 1000617

Oldart.no. 130000

EAN



• For connecting a variety of interchangeable heads produced by other manufacturers.
• Lightweight FiberComp™ construction.

Easy compatibility

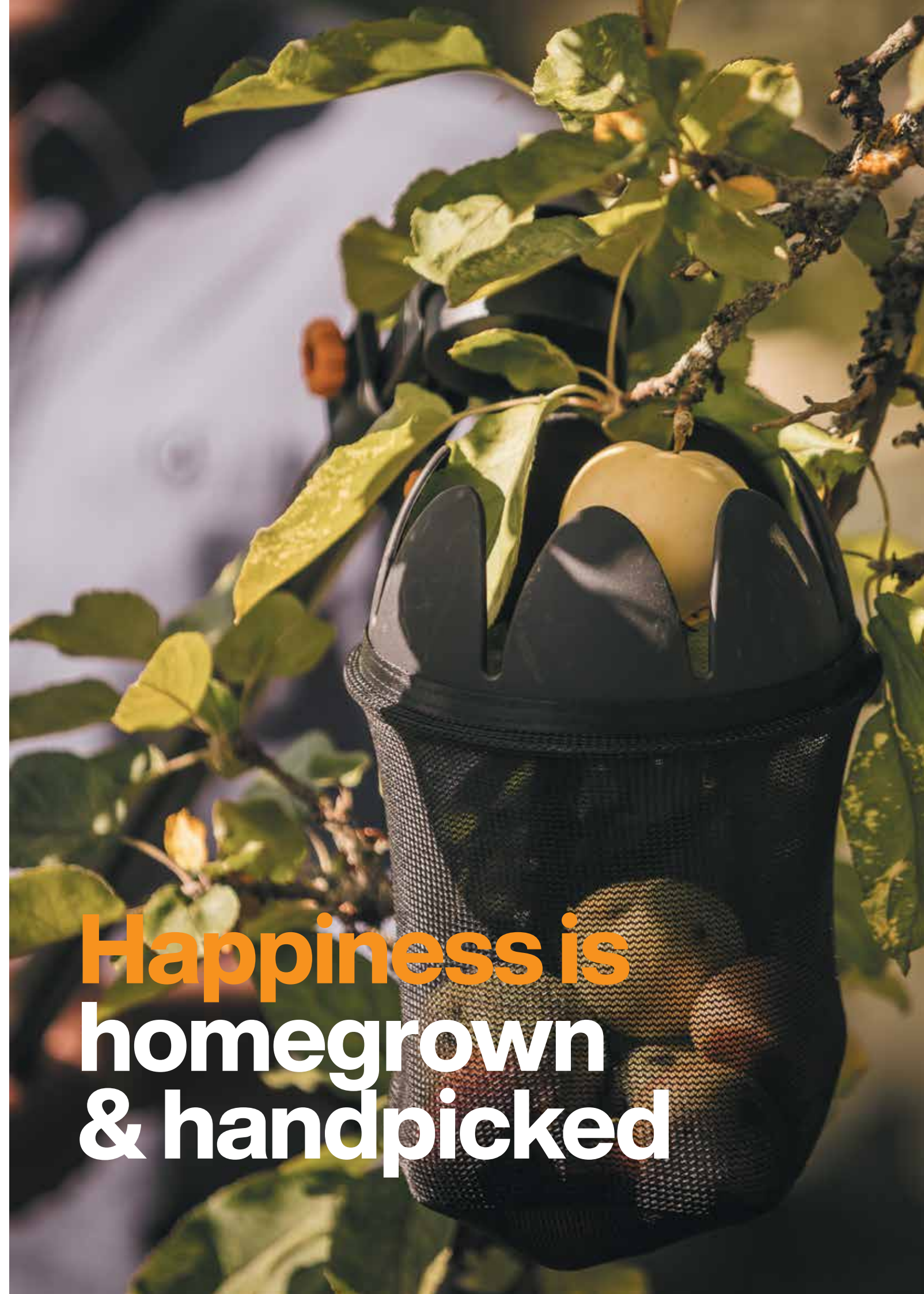
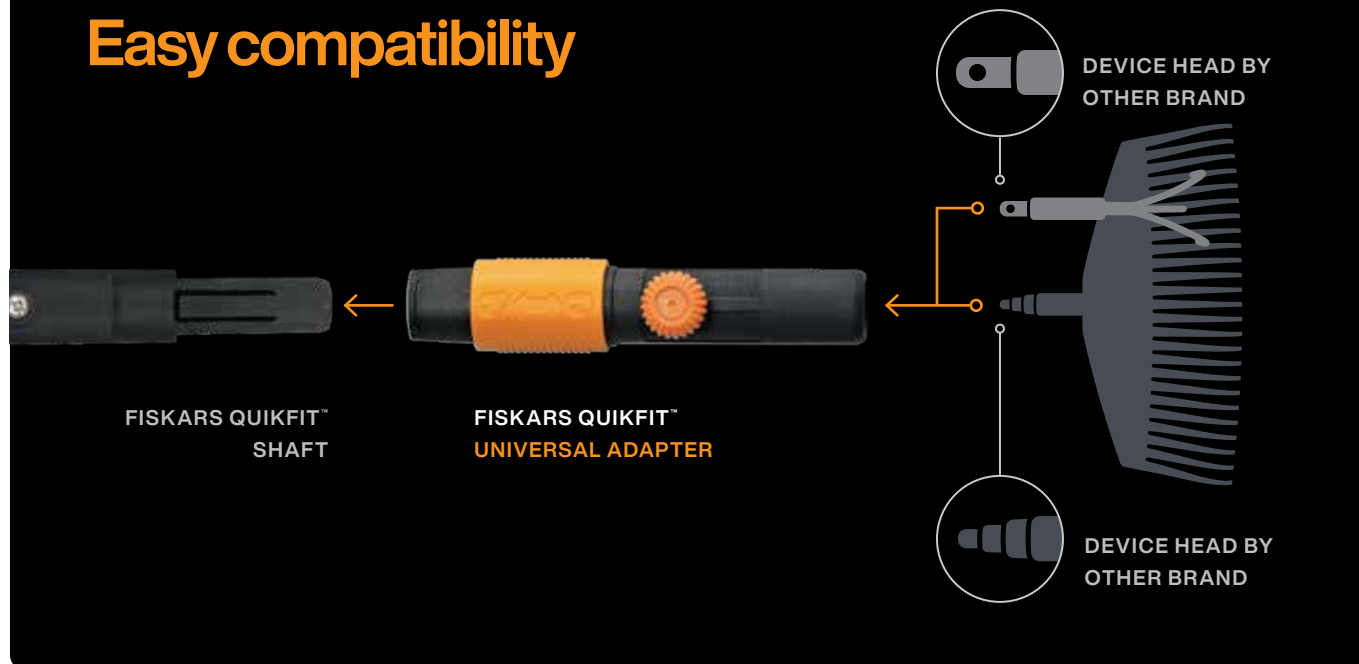

**Happiness is
homegrown
& handpicked**

Wood Preparation

Over 300 years of axe expertise.

In the midst of the Finnish woodlands lies the small village of Fiskars, where the timeless traditions of crafting the highest quality hand tools have been passed down through the generations since 1649.

Axes [p.148](#)

WoodXpert™ [p.160](#)

Yard clearing tools [p.168](#)

Saws [p.170](#)

Other Tools [p.173](#)

Knives [p.175](#)



Norden Axes



With Norden axes, Fiskars returns to its deep roots. The finest hickory is used to craft a handle with the authentic and natural feel of the traditional wooden axes. Yet as with all its axes, Fiskars always insists on the highest possible performance. After thorough testing, you can be sure that the blade will always stay attached, while enjoying unparalleled performance, endurance and durability.

Fiskars Norden.
Pure performance.



Features & benefits

Ultimate safety

- 1 Safest, undetachable axe head and shaft connections
- 2 Virtually unbreakable, FiberComp™ overstrike protection for lightweight, break- and shock-proof use
- 3 Hooked handle for secure grip & control

Unbeatable performance

- 4 Ultra stay-sharp blades are double-hardened to optimise strength in demanding situations.

Precision-ground cutting edge with low-friction coating.

- 5 Optimal weight balance
- 6 Optimally designed blades for chopping & splitting tasks

High quality, durable materials

- 7 High-quality, hickory wood handle made from sustainably managed forests
- 8 Carbon steel blades

FENNIAPRIZE 20
HONOURABLE MENTION



The mark of responsible forestry

Made in
Finland

Norden Axes

Norden Chopping Axe, N7					Art.no. 1051142	EAN 6 411501 701121
Height: 38,6 cm	Length: 3,3 cm	Width: 17,2 cm	Weight: 0,80 kg	Retail box: 4	Oldart.no. -	

MADE IN FINLAND

VPA GS HONOURABLE MENTION

FENNIAPRIZE 20

reddot award 2019 best of the best

GUARANTEE 25 YEARS

FSC www.fsc.org FSC® C108780 The mark of responsible forestry

- Small universal hatchet for limbing, chopping & kindling.
- Its compact size makes it a perfect companion for camping, hiking and other outdoor activities.
- Product: 3,2 x 35,5 x 13 cm.
- FSC® certified wood.

Norden Chopping Axe, N10					Art.no. 1051143	EAN 6 411501 701138
Height: 47,6 cm	Length: 3,5 cm	Width: 19,4 cm	Weight: 1,21 kg	Retail box: 4	Oldart.no. -	

MADE IN FINLAND

VPA GS HONOURABLE MENTION

FENNIAPRIZE 20

reddot award 2019 best of the best

GUARANTEE 25 YEARS

FSC www.fsc.org FSC® C108780 The mark of responsible forestry

- A great general tool for chopping & kindling tasks on the yard and small construction projects around the house.
- Its 44,5 cm handle makes it ideal for easy one-handed use.
- Product: 3,2 x 44,5 x 15,2 cm.
- FSC® certified wood.

Norden Splitting Axe, N12					Art.no. 1051144	EAN 6 411501 701145
Height: 52,6 cm	Length: 3,5 cm	Width: 19,4 cm	Weight: 1,30 kg	Retail box: 4	Oldart.no. -	

MADE IN FINLAND

VPA GS HONOURABLE MENTION

FENNIAPRIZE 20

reddot award 2019 best of the best

GUARANTEE 25 YEARS

FSC www.fsc.org FSC® C108780 The mark of responsible forestry

- For easy splitting of small sized logs up to Ø 20 cm.
- Its 50 cm shaft size makes it a perfect size also for 2 handed use.
- Product: 3,2 x 49,5 x 15,2 cm.
- FSC® certified wood.

Premium Axe Blade Cover, XS					Art.no. 1057531	EAN 6 411501 600332
Height: 18,8 cm	Length: 2,5 cm	Width: 10 cm	Weight: 0,04 kg	Retail box: 6	Oldart.no. -	

- Premium axe blade cover for safe storage & carrying.
- Made of recycled leather 100% natural materials.
- Snap closure ensures that blade cover stays in place.
- High quality leather with reinforced edge for sheath durability.
- Water resistant for axe protection against rust.
- Suitable axe blade cover for Fiskars axe models N7, X5, X7, A5 & A6.

Premium Axe Blade Cover, S					Art.no. 1057532	EAN 6 411501 600349
Height: 20,5 cm	Length: 3 cm	Width: 10 cm	Weight: 0,04 kg	Retail box: 6	Oldart.no. -	

- Premium axe blade cover for safe storage & carrying.
- Made of recycled leather 100% natural materials.
- Snap closure ensures that blade cover stays in place.
- High quality leather with reinforced edge for sheath durability.
- Water resistant for axe protection against rust.
- Suitable axe blade cover for Fiskars axe models N10, N12, X10, X11, A10 & A11.

Norden knives & sharpener

Norden Wood carving knife					Art.no. 1071897	EAN 6 411501 600769
Height: 4,4 cm	Length: 26,3 cm	Width: 9,3 cm	Weight: 0,10 kg	Retail box: 4	Oldart.no. -	



- Beautifully designed to enhance your woodworking, carving and whittling.
- Made of natural, highest-quality materials and crafted to last generations.
- Stainless steel blade is easy to sharpen & maintain, resists rust.
- Natural birch wood handle is comfortable and secure in your hand and is waxed for long-lasting durability. FSC® certified.
- Included recycled leather sheath is lined for reliable safety and blade protection.
- Blade length: 78mm; total length: 196mm.

Norden Outdoor knife					Art.no. 1072090	EAN 6 411501 600752
Height: 4,4 cm	Length: 26,3 cm	Width: 9,3 cm	Weight: 0,11 kg	Retail box: 4	Oldart.no. -	



- Beautiful and functional Outdoor knife excels at a range of tasks, from whittling and woodwork to camping, fishing and hunting.
- Made of natural, highest-quality materials and crafted to last generations.
- Stainless steel blade is easy to sharpen & maintain, resists rust.
- Natural birch wood handle is comfortable and secure in your hand.
- Wood handle is FSC® certified (FSC C108780) and is waxed for long-lasting durability.
- Included recycled leather sheath is lined for reliable safety and blade protection.
- Blade length: 98mm; total length: 215mm.

Norden axe and knife sharpener					Art.no. 1071898	EAN 6 411501 600776
Height: 5,0 cm	Length: 20,6 cm	Width: 5,9 cm	Weight: 0,13 kg	Retail box: 4	Oldart.no. -	



- Fiskars Norden Axe and knife sharpener optimises regular maintenance of axes and knives, guaranteeing cutting-edge sharpness.
- Sharpening slot ensures tool stays in place for safe sharpening.
- Ceramic grindstone efficiently sharpens in both directions.
- Ceramic finishing stone for fine-grinding.
- Authentic, natural birch wood body is FSC® certified (FSC C108780) and is comfortable in your hand.
- Recycled leather hanging loop for easy storage.
- Portable size is easy to take along on outdoor activities.

FISKARS®

Norden axes



- ✓ Ultimate blade performance
- ✓ FiberComp™ over-strike protection
- ✓ High quality Hickory wooden handle

Pure performance
www.fiskars.com



The mark of responsible forestry

X-series™ Axes



New

Fiskars X-Series™ axes are designed for ultimate performance; masterfully balanced to optimise swing speed and amplify user power for efficient splitting. With ultra-sharp, forged steel blades engineered to disperse wood more effectively, double hardened for sharp edge retention. Low-friction blade coating enables glide through after impact and offers rust protection. Over-molded axe heads provides an inseparable connection to the shafts. The virtually unbreakable design includes a lightweight, remarkably strong, FiberComp™ handle that absorbs shock and offers superior overstrike protection.

The handles have an oversized grip-zone with strategically textured SoftGrip™ and hooked end for user comfort. Designed in Billnäs, Finland, building on more than three-and-a-half centuries of the world's best forged tools.

NEW DESIGN

New improved splitting blade design for improved spitting performance

Wider cutting edge & wider splitting wedge improves splitting power & make the blades easier to remove from wood.

New ultra light hiking axe, masterfully designed for the outdoors

Light, sized for easy carrying, stowaway and comfortable single-handed use. It's orange handle is durable and easy-to-spot. Includes sheath for safety when driving tent stakes into the ground. With belt loop and reliable locking mechanism.

New ergonomically curved handle on small universal axes

provides a natural, comfortable wrist position during use.

X13 33,5 cm 0,48 kg log ø <3cm	 XXS size	
X14 35,5 cm 0,71 kg log ø <7 cm	 XS size	
X18 44,5 cm 1 kg log ø <10 cm	 S size	
X24 60 cm 1,6 kg	 M size	
X24S 60 cm 1,3 kg log ø 10-20 cm	 S size	
X24M 60 cm 1,7 kg log ø 20-30 cm	 M size	
X28 71 cm 1,8 kg log ø 20-30 cm	 M size	
X38 81,5 cm 2,4 kg log ø >30 cm	 L size	
X36 91,5 cm 2,5 kg log ø >30 cm	 L size	



Universal axes

Fiskars next-generation universal axes serve all manners of woodwork, chopping, carpentry and pruning. The range delivers a wonderful package of minimalist design and sharp-edged functionality with the right fit for all wood preparation tasks. Pick your size according to the task at hand. The Universal Axe's thin, wide edge ensures a clean, easy cut in fresh, resinous wood, like spruce or pine.



Splitting axes

Fiskars next-generation splitting axes are a true evolution of craftsmanship –purpose-designed for one strike splits of even the thickest logs. The special blade geometry and finish is complemented by a light sturdy shaft and perfect balance. Pick your size according to the task at hand.

The Splitting Axe features a unique cutting edge that easily slices into the wood, which the thick axe blade then pushes apart.

Made in

 Finland

GUARANTEE
25
 YEARS

NEW! X-series™ Chopping Axes

Ultra light hiking axe X13					Art.no. 1069101	EAN 6 411501 201607
Height: 33,5cm	Length: 3,0cm	Width: 14,0cm	Weight: 0,51kg	Retailbox: 4	Oldart.no. -	



MADE IN FINLAND

VPA GS **GUARANTEE 25 YEARS**

- The X13 Ultra light hiking axe is 15% lighter than other compact X-series™ axes, making it an ideal companion for chopping, kindling, general camping and hiking tasks.
- Proprietary double-hardened, forged steel blade with blade-grinding which provides a sharper edge for superior contact and cleaner cuts.
- Low-friction blade coating glides through wood and protects against rust.
- The FiberComp™ handle is easy-to-spot, durable and light.
- Blade cover features a belt loop and a reliable locking mechanism for safety while carrying & driving tent stakes with the striking end.

X14 Chopping axe XS blade					Art.no. 1069102	EAN 6 411501 201614
Height: 38,7cm	Length: 3,2cm	Width: 17,3cm	Weight: 0,79kg	Retailbox: 4	Oldart.no. -	



MADE IN FINLAND

VPA GS **GUARANTEE 25 YEARS**

- Ideal for limbing, kindling, general yard maintenance and carpentry.
- New improved forged steel blade design ensures clean, easy cuts.
- Proprietary blade-grinding provides a sharp edge, double-hardened to maintain its sharp edge longer.
- Low-friction blade coating for easy glide through & rust protection.
- Ultralight & durable FiberComp™ shaft construction is virtually unbreakable & offers superior overstrike protection.
- Ergonomic handle provides a neutral, comfortable wrist position during use, with textured SoftGrip™ for a comfortable, secure hold.

X18 Chopping axe S blade					Art.no. 1069103	EAN 6 411501 201621
Height: 47,5cm	Length: 3,2cm	Width: 19,2cm	Weight: 1,12kg	Retailbox: 4	Oldart.no. -	



MADE IN FINLAND

VPA GS **GUARANTEE 25 YEARS**

- Ideal for chopping kindling, general yard maintenance and carpentry.
- New improved forged steel blade design ensures clean, easy cuts.
- Proprietary blade-grinding provides a sharp edge, double-hardened to maintain its sharp edge longer.
- Low-friction blade coating for easy glide through & rust protection.
- Ultralight & durable FiberComp™ shaft construction is virtually unbreakable & offers superior overstrike protection.
- Ergonomic handle provides a neutral, comfortable wrist position during use, with textured SoftGrip™ for a comfortable, secure hold.

X24 Chopping axe M blade					Art.no. 1069104	EAN 6 411501 201638
Height: 63,5cm	Length: 3,5cm	Width: 20,7cm	Weight: 1,59kg	Retailbox: 4	Oldart.no. -	



MADE IN FINLAND

VPA GS **GUARANTEE 25 YEARS**

- Ideal for felling trees and all-purpose chopping.
- New improved forged steel blade design ensures clean, easy cuts.
- Proprietary blade-grinding provides a sharp edge, double-hardened to maintain its sharp edge longer.
- Low-friction blade coating for easy glide through & rust protection.
- Safest, undetachable axe head and shaft connection.
- Ultralight & durable FiberComp™ shaft construction is virtually unbreakable & offers superior overstrike protection.
- Perfected weight balance for more power at impact.
- Oversized, textured SoftGrip™ grip zone for comfort and control.

NEW! X-series™ Splitting Axes

X24 Splitting axe S blade					Art.no. 1069105	EAN 6 411501 201645
Height: 63,0cm	Length: 3,5cm	Width: 19,4cm	Weight: 1,29kg	Retailbox: 4	Oldart.no. -	



MADE IN FINLAND

VPA GS **GUARANTEE 25 YEARS**

- Ideal for splitting small to medium sized logs; 10-20cm diameter.
- New improved forged steel blade design adds power and makes the blade easier to remove from wood.
- Proprietary blade-grinding provides a sharp edge, double-hardened to maintain its sharp edge longer.
- Low-friction blade coating for easy glide through & rust protection.
- Ultralight & durable FiberComp™ shaft construction is virtually unbreakable & offers superior overstrike protection.
- Perfected weight balance for more power at impact.
- Oversized, textured SoftGrip™ grip zone for comfort and control.

X24 Splitting axe M blade					Art.no. 1069106	EAN 6 411501 201652
Height: 63,5cm	Length: 3,5cm	Width: 20,5cm	Weight: 1,74kg	Retailbox: 4	Oldart.no. -	



MADE IN FINLAND

VPA GS **GUARANTEE 25 YEARS**

- Ideal for ideal for splitting medium sized logs; 20-30cm diameter.
- New improved forged steel blade design adds power and makes the blade easier to remove from wood.
- Proprietary blade-grinding provides a sharp edge, double-hardened to maintain its sharp edge longer.
- Low-friction blade coating for easy glide through & rust protection.
- Ultralight & durable FiberComp™ shaft construction is virtually unbreakable & offers superior overstrike protection.
- Perfected weight balance for more power at impact.
- Oversized, textured SoftGrip™ grip zone for comfort and control.

X28 Splitting axe M blade					Art.no. 1069107	EAN 6 411501 201669
Height: 74,5cm	Length: 3,5cm	Width: 21,0cm	Weight: 1,84kg	Retailbox: 4	Oldart.no. -	



MADE IN FINLAND

VPA GS **GUARANTEE 25 YEARS**

- Ideal for ideal for splitting medium sized logs; 20-30cm diameter.
- New improved forged steel blade design adds power and makes the blade easier to remove from wood.
- Proprietary blade-grinding provides a sharp edge, double-hardened to maintain its sharp edge longer.
- Low-friction blade coating for easy glide through & rust protection.
- Ultralight & durable FiberComp™ shaft construction is virtually unbreakable & offers superior overstrike protection.
- Perfected weight balance for more power at impact.
- Oversized, textured SoftGrip™ grip zone for comfort and control.

X32 Splitting axe L blade					Art.no. 1069108	EAN 6 411501 201676
Height: 85,0cm	Length: 4,2cm	Width: 22,4cm	Weight: 2,52kg	Retailbox: 2	Oldart.no. -	



MADE IN FINLAND

VPA GS **GUARANTEE 25 YEARS**

- Ideal for splitting large logs, more than 30 cm diameter.
- New improved forged steel blade design adds power and makes the blade easier to remove from wood.
- Proprietary blade-grinding provides a sharp edge, double-hardened to maintain its sharp edge longer.
- Low-friction blade coating for easy glide through & rust protection.
- Ultralight & durable FiberComp™ shaft construction is virtually unbreakable & offers superior overstrike protection.
- Perfected weight balance for more power at impact.
- Oversized, textured SoftGrip™ grip zone for comfort and control.

X36 Splitting axe L blade					Art.no. 1069109	EAN 6 411501 201683
Height: 95,0cm	Length: 3,4cm	Width: 22,5cm	Weight: 2,50kg	Retailbox: 2	Oldart.no. -	



MADE IN FINLAND

VPA GS **GUARANTEE 25 YEARS**

- Ideal for splitting large logs, more than 30 cm diameter.
- New improved forged steel blade design adds power and makes the blade easier to remove from wood.
- Proprietary blade-grinding provides a sharp edge, double-hardened to maintain its sharp edge longer.
- Low-friction blade coating for easy glide through & rust protection.
- Ultralight & durable FiberComp™ shaft construction is virtually unbreakable & offers superior overstrike protection.
- Perfected weight balance for more power at impact.
- Oversized, textured SoftGrip™ grip zone for comfort and control.

X-series™ Axes



Fiskars next-generation splitting axes are a true evolution of craftsmanship, purposefully designed for one-strike splits of even the thickest logs. The special blade geometry and finish is complemented by a light sturdy shaft and perfect balance. Pick your size according to the task at hand.

KEY BENEFITS

- ✓ 35 degree convex cutting bevel angle for splitting axes - the convex shape strengthens the edge to make it less sensitive to fracture
- ✓ Perfect balance between head and shaft for the most safe, comfortable and efficient swing
- ✓ Ultralight and durable FiberComp™ shaft minimizes fatigue and makes the axe virtually unbreakable
- ✓ Optimal anti-shock surface structure ensures a comfortable, firm grip
- ✓ Hooked end of the handle prevents the axe from slipping out of the hand
- ✓ Comes with a plastic sheath for easy carrying and storage



CHOPPING AXES



< 3-10cm < 3-10cm < 3-10cm

X5 X7 X10

XXS XS S



SPLITTING AXES



10-20cm 20-30cm 20-30cm <30cm >30cm

X11 X17 X21 X25 X27

S M L XL XXL

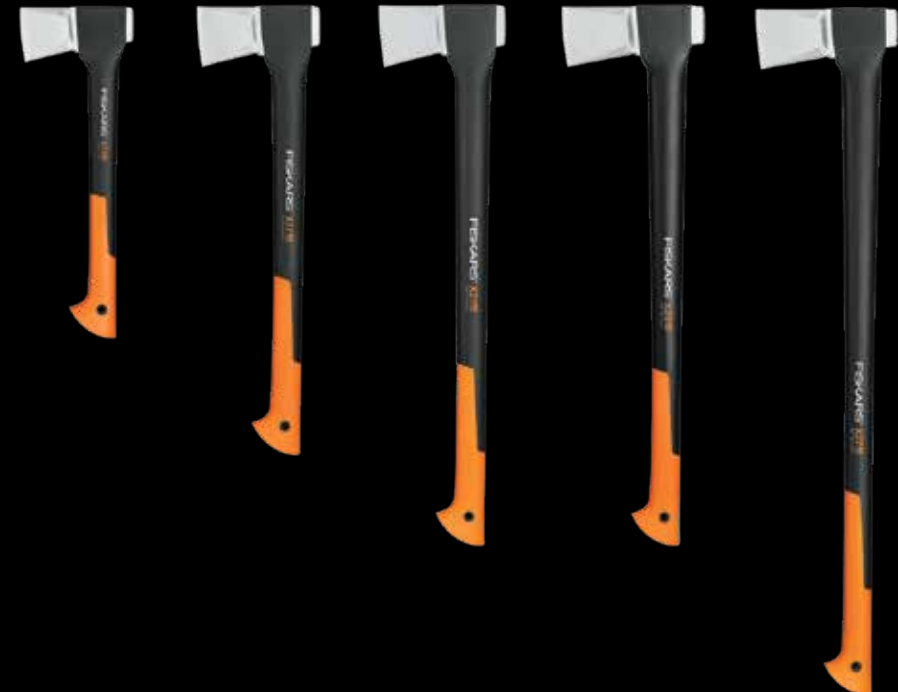

Chopping vs. splitting

Chopping axes

Fiskars next-generation chopping axes serve all manners of woodwork, chopping, carpentry and pruning. The range delivers a wonderful package of minimalist design and sharp-edged functionality with the right fit for all wood preparation tasks. Pick your size according to the task at hand.

The Universal Chopping Axe's thin, wide edge ensures a clean, easy cut in fresh, resinous wood, like spruce or pine.

Splitting axes

Fiskars next-generation splitting axes are a true evolution of craftsmanship - purpose-designed for one strike splits of even the thickest logs. The special blade geometry and finish is complemented by a light sturdy shaft and perfect balance. Pick your size according to the task at hand.

The Splitting Axe features a unique cutting edge that easily slices into the wood, which the thick axe blade then pushes apart.

X-series™ Splitting Axes

X-series™ Splitting Axe, S, X11					Art.no. 1015640	EAN 6 411501 224439
Height: 49,1cm	Length: 3,4cm	Width: 19,6cm	Weight: 1,09kg	Retailbox: 4	Oldart.no. 122443	



- For small size logs <20 cm.
- New 3D grip for increased safety and swing speed.
- New extended 25 years warranty via web registration.
- Product: 33 x 444 x 151 mm.



X-series™ Splitting Axe, M, X17					Art.no. 1015641	EAN 6 411501 224637
Height: 65,2cm	Length: 3,8cm	Width: 21cm	Weight: 1,55kg	Retailbox: 4	Oldart.no. 122463	



- For medium size logs >20 cm.
- New 3D grip for increased safety and swing speed.
- New extended 25 years warranty via web registration.
- Product: 36 x 600 x 165 mm.



X-series™ Splitting Axe, L, X21					Art.no. 1015642	EAN 6 411501 224736
Height: 77,5cm	Length: 4,5cm	Width: 24cm	Weight: 1,59kg	Retailbox: 2	Oldart.no. 122473	



- New model with perfected balance and high swing speed.
- For medium size logs 20 - 30 cm.
- New 3D grip for increased safety and swing speed.
- New extended 25 yrs warranty via web registration.
- Product: 36 x 709 x 165 mm.



X-series™ Splitting Axe, XL, X25					Art.no. 1015643	EAN 6 411501 224835
Height: 77,5cm	Length: 4,6cm	Width: 23,5cm	Weight: 2,43kg	Retailbox: 2	Oldart.no. 122483	



- For large logs > 30 cm.
- New 3D grip for increased safety and swing speed.
- New extended 25 years warranty via web registration.
- Product: 40 x 725 x 191 mm.



X-series™ Splitting Axe, XXL, X27					Art.no. 1015644	EAN 6 411501 225030
Height: 96cm	Length: 4,6cm	Width: 23,5cm	Weight: 2,56kg	Retailbox: 2	Oldart.no. 122503	



- For extra large logs > 30 cm.
- New 3D grip for increased safety and swing speed.
- New extended 25 years warranty via web registration.
- Product: 40 x 925 x 191 mm.



X-series™ Chopping Axes

X-series™ Camping Axe, XXS, X5					Art.no. 1015617	EAN 6 411501 211231
Height: 26,2cm	Length: 3,4cm	Width: 17,2cm	Weight: 0,57kg	Retailbox: 4	Oldart.no. 121123	



- For kindling small wood for camp fires.
- Redesigned blade cover for easy transportability.
- New extended 25 years warranty via web registration.
- Product: 28 x 231 x 130 mm.



X-series™ Chopping Axe, XS, X7					Art.no. 1015618	EAN 6 411501 214232
Height: 38,5cm	Length: 3,4cm	Width: 17,2cm	Weight: 0,64kg	Retailbox: 4	Oldart.no. 121423	



- For chopping small wood for camp fire.
- Redesigned blade cover for easy transportability.
- New extended 25 years warranty via web registration.
- Product: 33 x 354 x 130 mm.



X-series™ Chopping Axe, S, X10					Art.no. 1015619	EAN 6 411501 214430
Height: 47,6cm	Length: 3,4cm	Width: 19,6cm	Weight: 1,00kg	Retailbox: 4	Oldart.no. 121443	



- For carpentry and small wood work.
- Redesigned blade cover for easy transportability.
- New extended 25 years warranty via web registration.
- Product: 33 x 445 x 152 mm.



Xsharp™ Axe and Knife Sharpener					Art.no. 1000601	EAN 6 411501 207401
Height: 23,5cm	Length: 4cm	Width: 9cm	Weight: 0,09kg	Retailbox: 4	Oldart.no. 120740	



- 2 sharpeners in 1 for regular maintenance of your Fiskars axes and knives.
- Ceramic grind stone has clearly indicated cutting grooves for either axes or knives.
- Easy-to-use, optimised sharpening angle for Fiskars blades.
- Convenient portability.



Choose the right size for you



1. LENGTH TEST

Grab the axe on the shaft below the blade. Turn the shaft towards your armpit. If the end of the shaft reaches your armpit, the axe is too long.

2. WEIGHT TEST

Grab the axe at the end of the shaft and let the head rest towards the ground. Lift the head up while turning your wrist close to your body. The axe should be vertical in your hand by the end of this movement. If you can't lift the axe this way, the axe is too heavy.

WoodXpert™ Felling Levers

Fiskars WoodXpert™ felling levers facilitate the felling down of a tree, safely and ergonomically, and also assist in sectioning logs and transportation.

Features & benefits

- 1 Sturdy, forged, hardened steel head
- 2 Optimised lever tip steers trees safely while felling
- 3 Attachable/detachable WoodXpert™ log hook
- 4 Non-slip SoftGrip™ ergonomic handle
- 5 Robust, yet lightweight construction
- 6 Easy & fast lock interface



70 cm
M size



115 cm
L size

Single person use only.
Do not use damaged product.
Maximum load 150 kg (M) / 300 kg (L).



WoodXpert™ Felling Levers

WoodXpert™ Felling Lever, M

Height: 70 cm Length: 8,6 cm Width: 23 cm Weight: 1,80 kg Retail box: 4

Art.no. 1015438

Oldart.no. 126051



- For steering medium-sized trees when felling.
- Additionally functions as support for sawing and carrying logs.
- Forged, hardened steel blade.
- Sturdy, yet lightweight, special steel shaft.
- Fast lock interface for log hook and tongs interoperation.

WoodXpert™ Felling Lever, L

Height: 115 cm Length: 8,6 cm Width: 23 cm Weight: 2,70 kg Retail box: 2

Art.no. 1015439

Oldart.no. 126052



- For steering large-sized trees when felling.
- Additionally functions as support for sawing and carrying logs.
- Forged, hardened steel blade.
- Sturdy, yet lightweight, special steel shaft.
- Fast lock interface for log hook and tongs interoperation.

WoodXpert™ Brush Hooks

Fiskars WoodXpert™ brush hooks are a great choice for outdoor enthusiasts with a lot of clearing to do. Featuring precision-ground steel blades with a rust-resistant, low-friction coating, these hooks rip through underbrush and wood with speed and ease.

Features & benefits

- 1 Deep curved blade design is ideal for pull-cuts and lifting branches off the ground
- 2 Ultra-light and durable FiberComp™ shaft minimises fatigue and makes the shaft virtually unbreakable.
- 3 Hooked handle with SoftGrip™ for comfortable, non-slip grip
- 4 Made in Finland



M, XA3

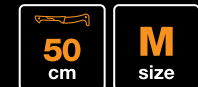

L, XA23



WoodXpert™ Brush Hooks

WoodXpert™ Brush Hook (XA3)

Art.no. 1003609

Height: 55cm

Length: 2,7cm

Width: 14,5cm

Weight: 0,51kg

Retail box: 4

Old art.no. 126004



- For cutting smaller branches from trees.
- For clearing weeds and brush in gardens and forests.
- For stripping bark from logs.

WoodXpert™ Brush Hook (XA23)

Art.no. 1003621

Height: 94,3cm

Length: 3,6cm

Width: 14,5cm

Weight: 1,00kg

Retail box: 2

Old art.no. 126005



- For cutting larger branches from trees / logs.
- For clearing saplings and brush in gardens and forests.
- For light chopping and splitting of firewood.

WoodXpert™ Log Hook & Tongs

Fiskars WoodXpert™ log hooks and tongs have been designed with an emphasis on comfort and control for safe, ergonomic and efficient, one-handed operation while lifting and turning logs.

Features & benefits

- 1 Lightweight boron steel hook with a toothed inlay grips logs with ease
- 2 Ergonomic handle with SoftGrip™. Engages all the fingers of the hand comfortably.
- 3 Wiregate clip for safe storage on a belt loop
- 4 Comes with a sturdy holster for easy storage and transport on a tool belt



WoodXpert™ Log Tools

WoodXpert™ Log Hook

Height: 31cm Length: 4cm Width: 21cm Weight: 0,41kg Retail box: 4

Art.no. 1003624



Old art.no. 126021



- Ideal for lifting, transporting, handling and arranging logs, as well as assisting during tree felling.
- Includes plastic sheath for easy transport on a tool belt.

WoodXpert™ Log Tongs

Height: 38,3cm Length: 4cm Width: 18cm Weight: 0,69kg Retail box: 4

Art.no. 1003625



Old art.no. 126031

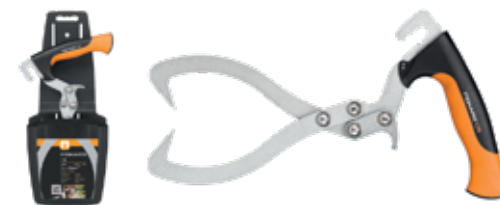

- Ideal for lifting, transporting, handling and arranging logs.
- Includes plastic sheath for easy transport on a tool belt.

WoodXpert™ Tool Belt

Height: 57cm Length: 4,5cm Width: 9cm Weight: 0,24kg Retail box: 4

Art.no. 1003626



Old art.no. 126009



- Tool belt for attaching log hooks and tongs.
- Ergonomic support for the back.
- Firm double tightening.

WoodXpert™ Sappies

Fiskars WoodXpert™ sappies are ideal for ergonomic, back-friendly handling of logs, e.g., lifting, transporting, arranging and turning logs during wood preparation. Developed with professional lumberjacks in mind, these tools feature an emphasis on lightweight performance, excellent grip and superior tool blade development, making them ideal for working longer with heavier logs.

Features & benefits

- 1 Hooked steel beak with a toothed inlay ensures solid grip
- 2 Ultralight and durable FiberComp™ shaft minimises fatigue and makes the shaft virtually unbreakable
- 3 Hooked handle with SoftGrip™ for comfortable, non-slip grip



WoodXpert™ Sappies

WoodXpert™ Sappie (XA2)

Height: 36,7 cm

Length: 3,2 cm

Width: 17,4 cm

Weight: 0,24 kg

Retail box: 4

Art.no. 1003622

Old art.no. 126006



EAN



- For carrying and lifting smaller logs.
- For handling and arranging wood piles.
- For turning of small logs.

WoodXpert™ Sappie (XA22)

Height: 77,5 cm

Length: 3,5 cm

Width: 23 cm

Weight: 0,80 kg

Retail box: 2

Art.no. 1003623

Old art.no. 126007



EAN



- For lifting and transporting larger logs.
- For handling and arranging wood piles.
- For turning of large logs.

Yard clearing Tools

Features & benefits

- 1 Blade curve offers pull cutting for removing suckers and clearing vines
- 2 Hardened steel blade holds its sharp edge
- 3 Coarse saw edge cuts fibrous plants or woody branches
- 4 Finger guard for safety during use
- 5 Textured SoftGrip™ handles fits the natural shape of your hand



Solid™ Yard Clearing Tools

Solid™ Billhook Saw

Height: 54 cm Length: 18,8 cm Width: 4,5 cm Weight: 0,68 kg Retail box: 4

Art.no. 1051233

Oldart.no. -



- Designed for fast, powerful clearing of thick vegetation.
- Blade is curved for quick pull cuts.
- One-handed use leaves other hand free to grab and pile cuttings.
- Textured SoftGrip™ handle helps prevent blisters.

Solid™ Machete

Height: 70 cm Length: 18,8 cm Width: 4,5 cm Weight: 0,89 kg Retail box: 4

Art.no. 1051235

Oldart.no. -



- Clear large areas of brush, cut thick branches and power through fibrous stems.
- Curved blade profile prevents blade from sticking.
- One-handed use leaves other hand free to grab and pile cuttings.
- Textured SoftGrip™ handle helps prevent blisters.

Solid™ Machete Axe

Height: 80,5 cm Length: 18,8 cm Width: 4,5 cm Weight: 1,08 kg Retail box: 4

Art.no. 1051236

Oldart.no. -



- Clear thick brush, chop roots, cut branches and more.
- Axe-like blade head provides powerful, controlled chopping and splitting.
- Blade is curved for quick pull cuts.
- One-handed use leaves other hand free to grab and pile cuttings.
- Textured SoftGrip™ handle helps prevent blisters.

Saws

To make sawing as easy as possible, you need a reliable saw that is up to the task. We have a variety of saws ranging from saws that cut stems and thicker branches to saws with curved noses for cutting in hard-to-reach or difficult positions.

Xtract™ Saws

Fiskars Xtract™ saws feature a unique, retractable mechanism and include an integrated belt clip for safe and easy transport and storage. Hardened steel blades ensure a long lifetime of sharpness, while a SoftGrip™ handle with finger guard ensures a safe grip.

Plus Folding saws

Fiskars Plus™ folding saws feature three cutting positions to allow you to approach every cut from the best angle. Power Tooth™ blades have razor-sharp, triple-ground teeth for quick and clean cutting, and a secure locking mechanism also holds the blade closed for safe storage and transport.

Fixed blade saws

Fiskars fixed blade saws feature a highly efficient tooth profile for fast, accurate sawing. Impulse-hardened blades stay sharper longer, while a SoftGrip™ ergonomic curved handle with finger guard ensures a safe and comfortable grip.

Bow Saws

Fiskars bow saws are excellent for sawing stems and thicker branches. A curved nose enables cutting in hard-to-reach or difficult positions. Bow saws also cut on both the push and pull stroke for efficient sawing.



Saws

Fiskars saws have teeth designed especially for wood. They allow you to prune branches and clear foliage in difficult positions safely with a lightweight saw. Fiskars Xtract™ range features a unique retractable mechanism and integrated belt clip making them safe to carry and easy to store.

! See high reach telescopic saws on page 52 (Tree pruners) & page 135 (QuikFit Curved saw)

Xtract™ Saws

Xtract™ Garden Saw, L (SW75)

Height: 39 cm	Length: 4 cm	Width: 9 cm	Weight: 0,23 kg	Retail box: 4	Art.no. 1000614	EAN 6 411501 238801
					Oldart.no. 123880	



- Efficiently saws fresh wood.
- Blade length 255 mm.
- Large cut capacity up to 220 mm.

Xtract™ Garden Saw, S (SW73)

Height: 27,5 cm	Length: 3,5 cm	Width: 9 cm	Weight: 0,12 kg	Retail box: 4	Art.no. 1000613	EAN 6 411501 238702
					Oldart.no. 123870	



- Efficiently saws fresh wood.
- Blade length 160 mm.
- Cut capacity 120 mm.

Xtract™ Builder's Saw (SW72)

Height: 27,5 cm	Length: 3,5 cm	Width: 9 cm	Weight: 0,12 kg	Retail box: 4	Art.no. 1000612	EAN 6 411501 238603
					Oldart.no. 123860	



- Fine teeth for dry wood, boards and wood strips.
- Blade length 160 mm.
- Cut capacity 120 mm.

Folding & Fixed Blade Saws

Plus Folding Saw SW69					Art.no. 1067553	EAN 6 411501 201348
Height: 33cm	Length: 2,8cm	Width: 12cm	Weight: 0,31kg	Retail box: 4	Oldart.no. -	



- Ideal for quick, clean cuts through thick stems and branches.
- 3 cutting positions: undercut for clean starting cuts, straight for general cuts and pistol-grip for added leverage.
- Blade length: 200 mm

Plus Folding Saw SW68					Art.no. 1067552	EAN 6 411501 201331
Height: 26,9cm	Length: 2,8cm	Width: 12cm	Weight: 0,25kg	Retail box: 4	Oldart.no. -	



- Ideal for quick, clean cuts through thick stems and branches.
- 3 cutting positions: undercut for clean starting cuts, straight for general cuts and pistol-grip for added leverage.
- Blade length: 150 mm

Professional Pruning Saw (SW-330)					Art.no. 1020199	EAN 6 411501 233301
Height: 59cm	Length: 4,9cm	Width: 16,4cm	Weight: 0,23kg	Retail box: 4	Oldart.no. 123330	



- Lightweight 230 g.
- Professional quality carbon steel blades, SK5.
- Blades for every task.
- Balanced weight distribution.
- Hollow grinded blade.
- Integrated sawdust removal teeth.
- Sturdy grip with SoftGrip®.
- Easy maintainability, all parts are replaceable.

Professional Pruning Saw (SW-240)					Art.no. 1020200	EAN 6 411501 232403
Height: 59cm	Length: 4,9cm	Width: 16,4cm	Weight: 0,20kg	Retail box: 4	Oldart.no. 123240	



- Lightweight 200 g.
- Professional quality carbon steel blades, SK5.
- Blades for every task.
- Balanced weight distribution.
- Hollow grinded blade.
- Integrated sawdust removal teeth.
- Sturdy grip with SoftGrip®.
- Easy maintainability, all parts are replaceable.

Fixed Blade Saw (SW84)					Art.no. 1001620	EAN 6 411501 238405
Height: 50cm	Length: 2,5cm	Width: 9,5cm	Weight: 0,34kg	Retail box: 4	Oldart.no. 123840	



- Blade length 320 mm.
- Cut capacity 150 mm.

21" Bow Saw (SW30)					Art.no. 1001621	EAN 5 702264 141004
Height: 62,5cm	Length: 1,9cm	Width: 21,5cm	Weight: 0,47kg	Retail box: 4	Oldart.no. 124800	



- Excellent for sawing 10-20 cm stems and branches.

24" Bow Saw (SW31)					Art.no. 1000615	EAN 5 702264 141011
Height: 70cm	Length: 1,9cm	Width: 21,5cm	Weight: 0,60kg	Retail box: 4	Oldart.no. 124810	



- Excellent for sawing >20 cm stems and thicker branches.

! Replacement parts available for professional pruning saws & bow saws. See pages 268 - 270.

Splitting Tools, Sledge Hammers & Wedges

Sledge Hammer, L					Art.no. 1001619	EAN 6 411501 200402
Height: 90cm	Length: 5,6cm	Width: 14cm	Weight: 4,1kg	Retail box: 2	Oldart.no. 120040	



- Delayed burring and less risk of chipping due to rounded edges on the striking surface.
- Less jarring from mis-hits due to rubber mis-hit guard.
- Greater resistance and comfort due to fiberglass core and elastomeric, anti-slip, anti-vibration handle.

Sledge Hammer, XL					Art.no. 1001431	EAN 6 411501 200303
Height: 90cm	Length: 6cm	Width: 15cm	Weight: 5,1kg	Retail box: 2	Oldart.no. 120030	



- Delayed burring and less risk of chipping due to rounded edges on the striking surface.
- Less jarring from mis-hits due to rubber mis-hit guard.
- Greater resistance and comfort due to fiberglass core and elastomeric, anti-slip, anti-vibration handle.

Sledge Hammer, XXL					Art.no. 1001618	EAN 6 411501 200280
Height: 90cm	Length: 7cm	Width: 16,5cm	Weight: 5,8kg	Retail box: 2	Oldart.no. 120028	



- Delayed burring and less risk of chipping due to rounded edges on the striking surface.
- Less jarring from mis-hits due to rubber mis-hit guard.
- Greater resistance and comfort due to fiberglass core and elastomeric, anti-slip, anti-vibration handle.

Helicoidal Splitting Wedge SAFE-T					Art.no. 1001615	EAN 6 411501 200211
Height: 26cm	Length: 6,5cm	Width: 6,5cm	Weight: 2,15kg	Retail box: 4	Oldart.no. 120021	



- Helicoidal shape makes the wood burst more easily, eliminating the need to use several wedges.
- Highly-resistant, polyamide striking surface and metal ring.
- Reduced risk of flying particles also eliminates the need to maintain the striking surface to remove burring.

Spare Striking Surface					Art.no. 1001616	EAN 3 157331 221516
Height: 6,5cm	Length: 4,5cm	Width: 6,5cm	Weight: 0,30kg	Retail box: 1	Oldart.no. 122151	



- Replaceable striking surface for Helicoidal Splitting Wedge SAFE-T (article No 1001615).

Splitting Wedge Drop Forged					Art.no. 1001614	EAN 6 411503 164603
Height: 20,5cm	Length: 5,2cm	Width: 8cm	Weight: 0,71kg	Retail box: 4	Oldart.no. 120010	



- For splitting difficult logs.
- Forged steel.
- Lightweight.

Splitting Wedge Helicoidal					Art.no. 1000600	EAN 6 411501 200204
Height: 21cm	Length: 6cm	Width: 4,5cm	Weight: 2,20kg	Retail box: 4	Oldart.no. 120020	



- Helicoidal shape makes the wood burst more easily, eliminating the need to use several wedges.
- Rounded head helps eliminate material fragmentation.
- Anti-return slot.
- Forged steel.

Knives

Fiskars designs knives for a range of smaller gardening applications. Their hard-wearing blades are made from stainless steel to ensure years of trouble-free operation.

Utility Knife (K40)					Art.no. 1001622	EAN 6 411502 870628
Height: 22,2cm	Length: 3,3cm	Width: 9cm	Weight: 0,07kg	Retail box: 4	Oldart.no. 125860	



- General purpose knife with plastic sheath.
- Ergonomically designed plastic handle with finger guard.
- Stainless steel blade, length 100 mm.

Hooked Grafting Knife (K62)					Art.no. 1001623	EAN 8 008220 020473
Height: 17cm	Length: 1,2cm	Width: 2,3cm	Weight: 0,05kg	Retail box: 4	Oldart.no. 125880	



- For taking cuttings, picking flowers and vegetables and cutting laterals.
- Handle of recycled plastic attached with a brass rivet.
- Stainless steel blade.

Grafting Pen Knife (K60)					Art.no. 1001625	EAN 8 008220 020497
Height: 16,8cm	Length: 1,2cm	Width: 2,3cm	Weight: 0,05kg	Retail box: 4	Oldart.no. 125900	



- Ideal for grafting and making wooden canes for holding small plants and bushes.
- Handle of recycled plastic attached with a brass rivet.
- Stainless steel blade.

Mineral Wool Knife (K20)					Art.no. 1001626	EAN 6 411502 879027
Height: 42cm	Length: 1,8cm	Width: 3,8cm	Weight: 0,14kg	Retail box: 4	Oldart.no. 125870	



- For cutting mineral wool.
- Ergonomically designed handle with finger guard.
- Stainless steel blade.

Make watering a joy

Waterwheels [p.168](#)

Hoses [p.172](#)

Sprinklers [p.178](#)

Spray Nozzles [p.182](#)

Connectors [p.190](#)

Accessories [p.202](#)



Waterwheel XL & Waterwheel XL, with wheels

Freestanding placement and 360° rotation

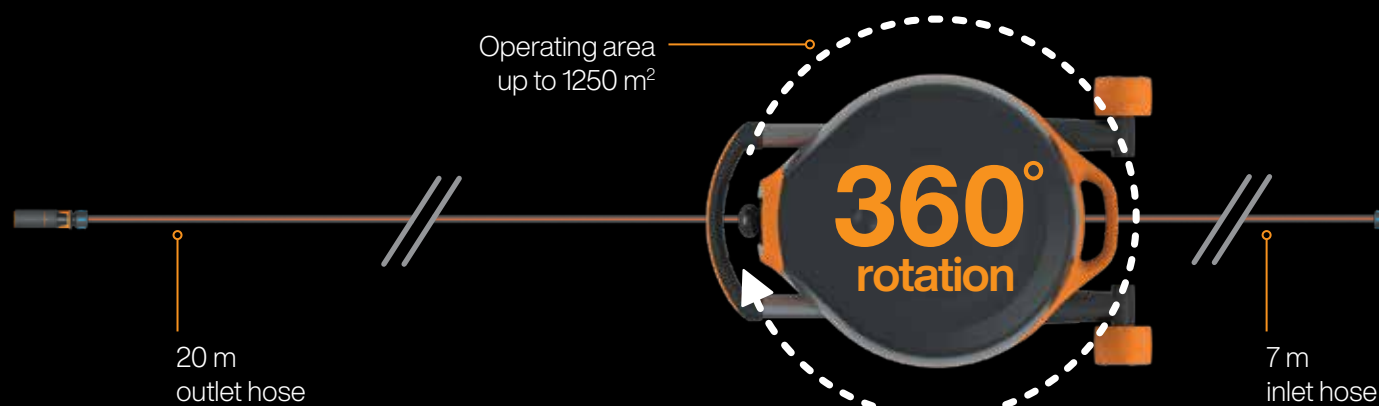

Choose the right product for your watering needs

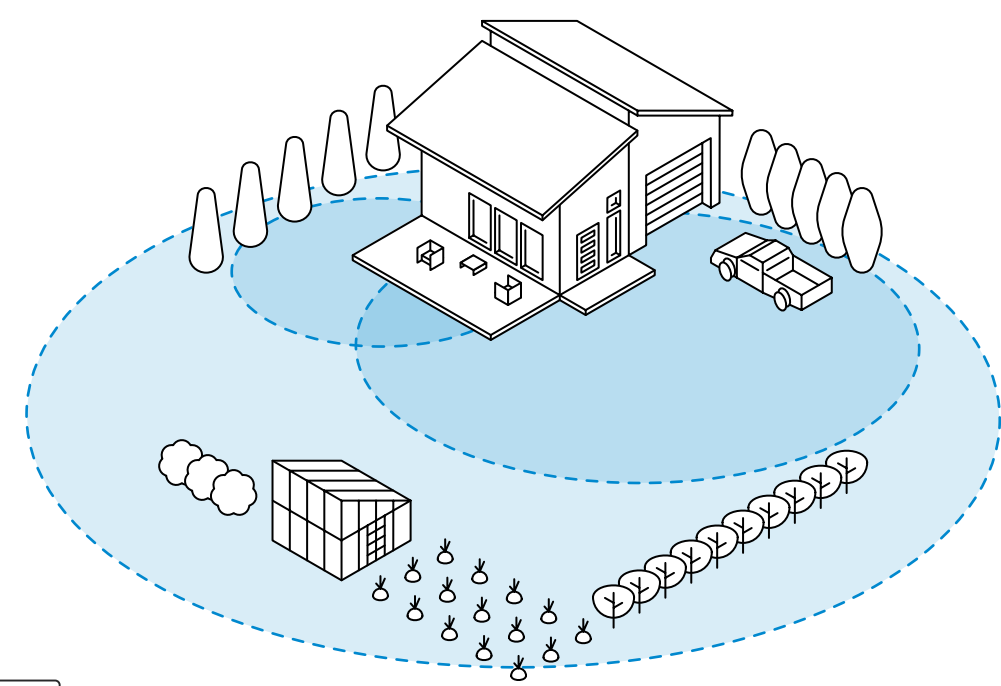

See the packaging symbols for garden size suggestions

S 0 - 150 m ²	M 50 - 300 m ²	L 300 - 500 m ²	XL > 500 m ²
------------------------------------	-------------------------------------	--------------------------------------	-----------------------------------

Waterwheels

X-series™ Waterwheel XL, automatic with wheels					Art.no. 1067548	EAN  6 411501 512598
Height: 60,0 cm	Length: 26,5 cm	Width: 50,0 cm	Weight: 11,50 kg	Retail box: 1	Oldart.no. 1025066	



- Ready-to-go set with handy accessory storage locker.
- Freestanding placement and 360° rotation for an extra-wide watering area.
- Automatic reel-in hose.
- Horizontal design prevents reel from tipping.
- Wheels for easy movement.

X-series™ Waterwheel XL, automatic					Art.no. 1067549	EAN  6 411501 512604
Height: 55,2 cm	Length: 26,5 cm	Width: 50,0 cm	Weight: 10,50 kg	Retail box: 1	Oldart.no. 1025067	



- Ready-to-go set.
- Freestanding placement and 360° rotation for an extra-wide watering area.
- Automatic reel-in hose.
- Horizontal design prevents reel from tipping.
- Can be wall mounted (wall mount sold separately).

Waterwheel Manual XL with wheels, all-in					Art.no. 1062256	EAN 6 411501 512369
Height: 60,2cm	Length: 43,1cm	Width: 49,3cm	Weight: 6,95kg	Retailbox: 2	Oldart.no. -	



21.5
meters reach



Universal fit.
Fits with other brands.

- The Waterwheel XL Manual Reel is ready to use – with all parts included and pre-installed.
- Included 13mm (1/2") outlet hose is 20m, connectors, hose nozzle.
- Free-standing placement and 360° rotation offer extra-wide watering area, while horizontal in-use design prevents tipping.
- Oscillator evenly allocates hose while reeling in.
- Durable construction for long-lasting use.
- Universal fit – Fits with other brands.

Waterwheel Manual XL with wheels, empty					Art.no. 1062257	EAN 6 411501 512376
Height: 60,2cm	Length: 43,1cm	Width: 49,3cm	Weight: 4,05kg	Retailbox: 2	Oldart.no. -	



50
meters reach



Universal fit.
Fits with other brands.

- The Waterwheel XL Manual Reel comes empty, allowing you to choose the hose and accessories.
- Reel has maximum hose capacity of 19mm (3/4") - 30m, 15mm (5/8") - 40 m and 13mm (1/2") - 50m.
- Free-standing placement and 360° rotation offer extra-wide watering area, while horizontal in-use design prevents tipping.
- Oscillator evenly allocates hose while reeling in.
- Durable construction for long-lasting use.
- Universal fit – Fits with other brands.

Comfort Waterwheel L, with 30 m hose					Art.no. 1071670	EAN 6 411501 512840
Height: 56,6cm	Length: 25cm	Width: 39,8cm	Weight: 6,75kg	Retailbox: 1	Oldart.no. 1025065	



31.5
meters reach



Universal fit.
Fits with other brands.

- Ready-to-go set with handy accessory storage locker.
- Freestanding placement and 360° rotation for an extra-wide watering area.
- Total reach up to 31,5 m.
- Durable 13 mm (1/2") hose.
- Convenient reel cart for easy movement.
- Easy to roll-out and recoil the hose.
- Easy to operate due to horizontal reel setting.

Comfort Waterwheel M, with 20 m hose					Art.no. 1071639	EAN 6 411501 512833
Height: 56,6cm	Length: 25cm	Width: 39,8cm	Weight: 5,60kg	Retailbox: 1	Oldart.no. 1025935	



21.5
meters reach



Universal fit.
Fits with other brands.

- Ready-to-go set with handy accessory storage locker.
- Freestanding placement and 360° rotation for an extra-wide watering area.
- Total reach up to 21,5 m.
- Durable 13 mm (1/2") hose.
- Convenient reel cart for easy movement.
- Easy to roll-out and recoil the hose.
- Easy to operate due to horizontal reel setting.

Comfort Waterwheel S, with 15m hose					Art.no. 1071660	EAN 6 411501 512826
Height: 44,4cm	Length: 16,1cm	Width: 39,0cm	Weight: 3,02kg	Retailbox: 4	Oldart.no. 1025934	



15
meters reach



Universal fit.
Fits with other brands.

FENNIaprize 17
HONOURABLE MENTION

- Ready-to-go set with handy accessory storage locker.
- Free horizontal placement and 360° rotation.
- Total reach up to 15 m.
- Durable 9 mm (3/8") hose.
- Lightweight design.
- Easy to roll-out and coil-in the hose.
- Easy to operate due to horizontal reel setting.
- Can be wall mounted (wall mount sold separately).

Solid™ Waterwheel L, with 30 m hose					Art.no. 1057237	EAN 6 411501 511874
Height: 47,8cm	Length: 24,7cm	Width: 47,8cm	Weight: 6,05kg	Retailbox: 1	Oldart.no. -	



31.5
meters reach

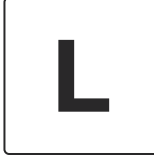

Universal fit.
Fits with other brands.

- Value-priced set contains 13 mm (1/2") hose, reel and accessories.
- Free-standing horizontal placement and 360° rotation offer extra-wide watering area.
- Total reach up to 31,5 m.
- Compact size for easy movement.

Solid™ Waterwheel M, with 20 m hose					Art.no. 1057238	EAN 6 411501 511881
Height: 47,8cm	Length: 24,7cm	Width: 47,8cm	Weight: 4,95kg	Retailbox: 1	Oldart.no. -	



21.5
meters reach



Universal fit.
Fits with other brands.

- Value-priced set contains 13 mm (1/2") hose, reel and accessories.
- Free-standing horizontal placement and 360° rotation offer extra-wide watering area.
- Total reach up to 21,5 m.
- Compact size for easy movement.

Watering Hoses

Easy to select Choose the right quality hose for your garden

High quality 3-layer hose with cross enforcement.
High pressure tested, twist- & UV-resistant.

Q3
Twist resistancy level



Q4
Twist resistancy level



Q5
Twist resistancy level

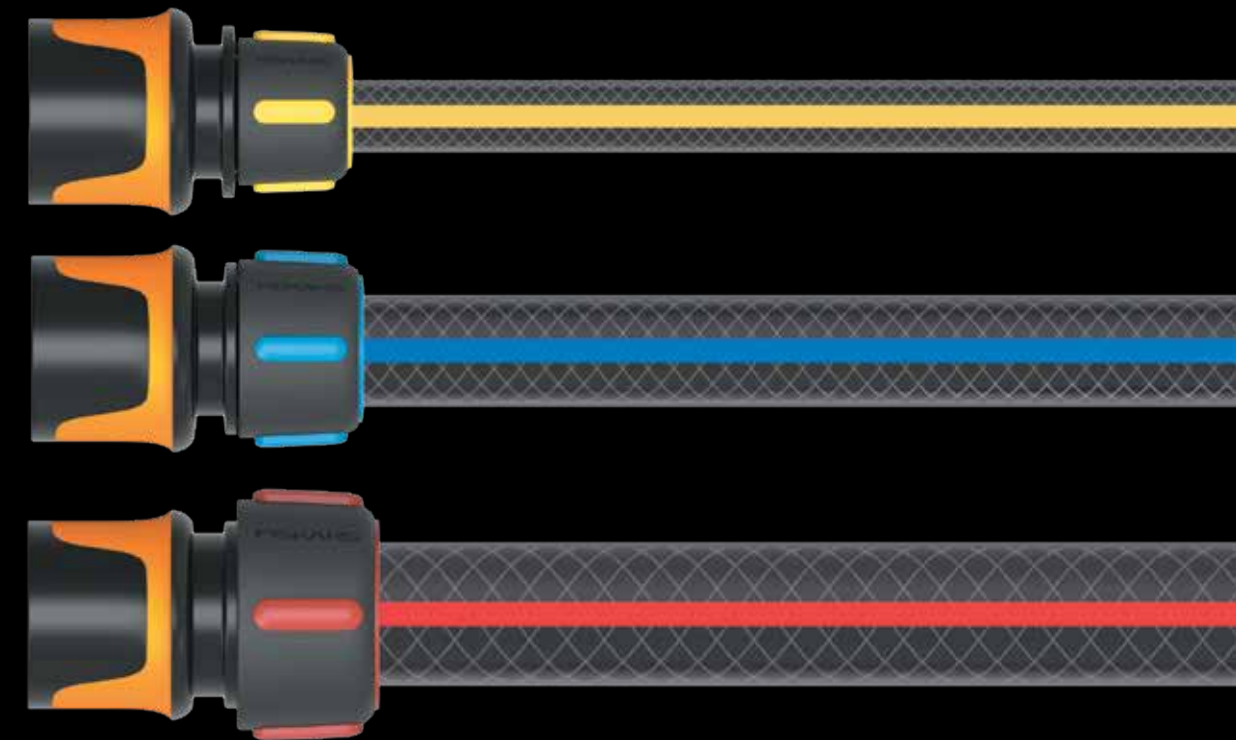
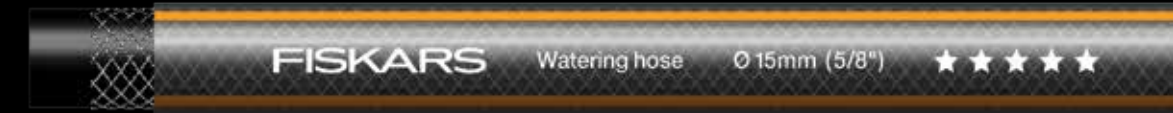
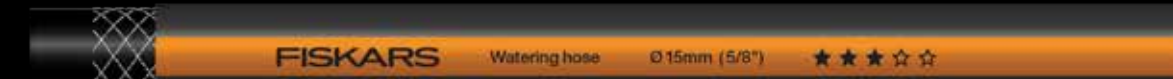

Universal fit.
Fits with other brands.

Universal fit

Already own watering products from other brands? No problem. Our watering products are designed to fit with other brands.

Hoses

Fiskars offers a range of high-quality watering hoses for garden sizes ranging from small to extra large. Our hoses are twist- and UV-resistant for added durability.

Hose length and diameter can be found by the hose name. Packaging measurements included in the table.

Watering Hose, 13mm (1/2"), 20 m Q3						Art.no. 1027102	EAN	6 411501 511270
Height: 39,5 cm	Length: 39,5 cm	Width: 6,5 cm	Weight: 2,50 kg	Retail box: 2	Old art.no. -			



★★★★☆

UV resistant

Pressure tested

S-M

13mm (1/2")
Universal fit. Fits with other brands.

- Easy-to-handle, twist-resistant hose.
- Twist resistancy level 3.
- UV protected.
- Phthalate free.
- Colour coded for easy matching between hose and connector.

Watering Hose, 13mm (1/2"), 20 m Q4						Art.no. 1027104	EAN	6 411501 511294
Height: 39,5 cm	Length: 39,5 cm	Width: 6,5 cm	Weight: 2,80 kg	Retail box: 2	Old art.no. -			



★★★★☆

UV resistant

Pressure tested

S-M

13mm (1/2")
Universal fit. Fits with other brands.

- Easy-to-handle, twist-resistant hose.
- Twist resistancy level 4.
- UV protected.
- Phthalate free.
- Colour coded for easy matching between hose and connector.

Watering Hose, 13mm (1/2"), 20 m Q5						Art.no. 1027107	EAN	6 411501 511324
Height: 39,5 cm	Length: 39,5 cm	Width: 6,5 cm	Weight: 2,90 kg	Retail box: 2	Old art.no. -			



★★★★★

UV resistant

Pressure tested

S-M

13mm (1/2")
Universal fit. Fits with other brands.

- Easy-to-handle, twist-resistant hose.
- Twist resistancy level 5.
- UV protected.
- Phthalate free.
- Colour coded for easy matching between hose and connector.

Watering Hose, 13mm (1/2"), 30 m Q3						Art.no. 1027103	EAN	6 411501 511287
Height: 39,5 cm	Length: 39,5 cm	Width: 10,0 cm	Weight: 3,75 kg	Retail box: 2	Old art.no. -			



★★★★☆

UV resistant

Pressure tested

L

13mm (1/2")
Universal fit. Fits with other brands.

- Easy-to-handle, twist-resistant hose.
- Twist resistancy level 3.
- UV protected.
- Phthalate free.
- Colour coded for easy matching between hose and connector.

Watering Hose, 13mm (1/2"), 30 m Q4						Art.no. 1027105	EAN	6 411501 511300
Height: 39,5 cm	Length: 39,5 cm	Width: 10,0 cm	Weight: 4,20 kg	Retail box: 2	Old art.no. -			



★★★★☆

UV resistant

Pressure tested

L

13mm (1/2")
Universal fit. Fits with other brands.

- Easy-to-handle, twist-resistant hose.
- Twist resistancy level 4.
- UV protected.
- Phthalate free.
- Colour coded for easy matching between hose and connector.

Watering Hose, 13mm (1/2"), 30 m Q5						Art.no. 1027108	EAN	6 411501 511331
Height: 39,5 cm	Length: 39,5 cm	Width: 10,0 cm	Weight: 4,35 kg	Retail box: 2	Old art.no. -			



★★★★★

UV resistant

Pressure tested

L

13mm (1/2")
Universal fit. Fits with other brands.

- Easy-to-handle, twist-resistant hose.
- Twist resistancy level 5.
- UV protected.
- Phthalate free.
- Colour coded for easy matching between hose and connector.

Watering Hose, 13mm (1/2"), 50 m Q4						Art.no. 1027106	EAN	6 411501 511317
Height: 39,5 cm	Length: 39,5 cm	Width: 14,5 cm	Weight: 7,00 kg	Retail box: 2	Old art.no. -			



★★★★☆

UV resistant

Pressure tested

XL

13mm (1/2")
Universal fit. Fits with other brands.

- Easy-to-handle, twist-resistant hose.
- Twist resistancy level 4.
- UV protected.
- Phthalate free.
- Colour coded for easy matching between hose and connector.

Watering Hose, 19mm (3/4"), 20 m Q3						Art.no. 1027109	EAN	6 411501 511348
Height: 39,5 cm	Length: 39,5 cm	Width: 11,5 cm	Weight: 4,30 kg	Retail box: 2	Old art.no. -			



★★★★☆

UV resistant

Pressure tested

M-L

19mm (3/4")
Universal fit. Fits with other brands.

- Easy-to-handle, twist-resistant hose.
- Twist resistancy level 3.
- UV protected.
- Phthalate free.
- Colour coded for easy matching between hose and connector.

Watering Hose, 19mm (3/4"), 20 m Q4						Art.no. 1027110	EAN	6 411501 511355
Height: 39,5 cm	Length: 39,5 cm	Width: 11,5 cm	Weight: 4,70 kg	Retail box: 2	Old art.no. -			



★★★★☆

UV resistant

Pressure tested

S-M

19mm (3/4")
Universal fit. Fits with other brands.

- Easy-to-handle, twist-resistant hose.
- Twist resistancy level 4.
- UV protected.
- Phthalate free.
- Colour coded for easy matching between hose and connector.

Watering Hose, 19mm (3/4"), 25 m Q3					Art.no. 1027100	EAN 6 411501 511256
Height: 39,5 cm	Length: 39,5 cm	Width: 12,0 cm	Weight: 4,96 kg	Retailbox: 2	Oldart.no. -	



- Easy-to-handle, twist-resistant hose.
- Twist resistancy level 3.
- UV protected.
- Phthalate free.
- Colour coded for easy matching between hose and connector.

Watering Hose, 19mm (3/4"), 50 m Q4					Art.no. 1027111	EAN 6 411501 511362
Height: 39,5 cm	Length: 39,5 cm	Width: 27,5 cm	Weight: 11,75 kg	Retailbox: 2	Oldart.no. -	



- Easy-to-handle, twist-resistant hose.
- Twist resistancy level 4.
- UV protected.
- Phthalate free.
- Colour coded for easy matching between hose and connector.

Hose Set Premium, 9mm (3/8") 15 m Q4					Art.no. 1027101	EAN 6 411501 511263
Height: 26,0 cm	Length: 25,5 cm	Width: 10,5 cm	Weight: 1,46 kg	Retailbox: 2	Oldart.no. -	

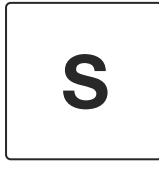

- High-quality, easy-to-handle 9mm (3/8") cross-enforced hose.
- Two quick hose connectors 9mm (3/8") with colour coding and one extension connector.
- Twist resistancy level 4.
- UV protected.
- Phthalate free.
- Colour coded for easy matching between hose and connector.

Hose Hanger Set, with hose 13mm (1/2"), 15 m Q4					Art.no. 1027678	EAN 6 411501 511393
Height: 39,5 cm	Length: 39,0 cm	Width: 6,5 cm	Weight: 2,05 kg	Retailbox: 2	Oldart.no. -	



- Increase reach of Waterwheels or use alone for small garden watering.
- Durable wall-mounting unit.
- Fasteners included for wall-mounting.
- Hose twist resistancy level 4.
- UV protected.
- Phthalate free hose.
- Colour coded for easy matching between hose and connector.

Hose Set, 13mm (1/2"), 1.8 m Q4					Art.no. 1057621	EAN 6 411501 511959
Height: 29,5 cm	Length: 26,5 cm	Width: 4,2 cm	Weight: 0,41 kg	Retailbox: 6	Oldart.no. -	



- Connecting hose for reel, micro drip system to watering source.
- Hose 13mm-15mm (1/2-5/8") 18 m Q4.
- Quick hose connector, 13mm-15mm (1/2-5/8") STOP.
- Quick hose connector, 13mm-15mm (1/2-5/8") FLOW.
- Tab connector Multi with Ø21mm (G 1/2"), Ø265 mm (G 3/4") and Ø333mm (G 1") threads.

Soaker Hose, 15 m					Art.no. 1025935	EAN 6 411501 510631
Height: 38,0 cm	Length: 36,0 cm	Width: 6,5 cm	Weight: 1,63 kg	Retailbox: 2	Oldart.no. -	



- Reduce water usage by up to 70%.
- 15 m hose length.
- Can be cut to right length using scissors.
- Flow control valve for adjusting water flow & pressure.
- Pack includes 5 metal clamps for effortless mounting.
- UV protected.



Sprinklers

Sprinklers

Fiskars sprinklers are easy to use and cover garden sizes from small to extra large, with a wide variety of easily adjustable spray areas.

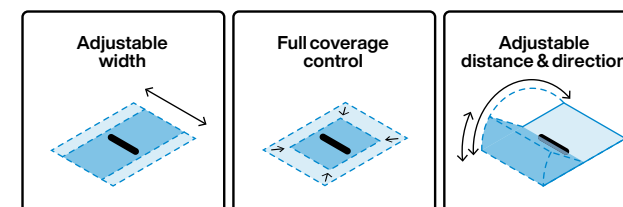

X-series™ Oscillating sprinkler S-L						Art.no. 1070831	EAN 6 411501 512727
Height: 63,2cm	Length: 6,0cm	Width: 9,8cm	Weight: 0,65kg	Retail box: 6	Oldart.no. -		



Universal fit. Fits with other brands.

Garden size recommendation **S-L** < 500 m²

Adjustable width: 8-16m

Full coverage control: < 340m²

Adjustable distance & direction: 6-21m

- Provides the highest level of adjustability for optimal water usage - adjust coverage to avoid watering sidewalks, walls and more.
- Intuitive, non-slip controls adjust width, distance and direction.
- Infinite flow for full coverage control.
- Easy, compact storage thanks to pivoting leg, easy cleaning.
- Coverage max. 16m - 21m (340m²).
- Universal quick connector, works with other brands.

X-series™ Oscillating sprinkler S-M						Art.no. 1070832	EAN 6 411501 512734
Height: 59,0cm	Length: 6,0cm	Width: 9,8cm	Weight: 0,62kg	Retail box: 6	Oldart.no. -		



Universal fit. Fits with other brands.

Garden size recommendation **S-M** < 300 m²

Adjustable width: 5-15m

Full coverage control: < 300m²

Adjustable distance & direction: 4-20m

- Provides the highest level of adjustability for optimal water usage - adjust coverage to avoid watering sidewalks, walls and more.
- Intuitive, non-slip controls adjust width, distance and direction.
- Infinite flow for full coverage control.
- Easy, compact storage thanks to pivoting leg, easy cleaning.
- Coverage max. 15m - 20m (300m²).
- Universal quick connector, works with other brands.

Comfort Oscillating sprinkler S-L						Art.no. 1070833	EAN 6 411501 512741
Height: 53,4cm	Length: 6,0cm	Width: 9,8cm	Weight: 0,51kg	Retail box: 6	Oldart.no. -		



Universal fit. Fits with other brands.

Garden size recommendation **S-L** < 500 m²

Full coverage control: < 325m²

Adjustable distance & direction: 5-19m

- Provides adjustability to optimize water coverage.
- Intuitive, non-slip controls adjust distance and direction.
- Infinite flow for full coverage control.
- Easy, compact storage thanks to pivoting leg, easy cleaning.
- Coverage max. 17m - 19m (325m²).
- Universal quick connector, works with other brands.

Comfort Oscillating sprinkler S-M						Art.no. 1070834	EAN 6 411501 512758
Height: 49,6cm	Length: 6,0cm	Width: 9,8cm	Weight: 0,48kg	Retail box: 6	Oldart.no. -		



Universal fit. Fits with other brands.

Garden size recommendation **S-M** < 300 m²

Full coverage control: < 285m²

Adjustable distance & direction: 5-19m

- Provides adjustability to optimize water coverage.
- Intuitive, non-slip controls adjust distance and direction.
- Infinite flow for full coverage control.
- Easy, compact storage thanks to pivoting leg, easy cleaning.
- Coverage max. 15m - 19m (285m²).
- Universal quick connector, works with other brands.

Solid™ Oscillating sprinkler M					Art.no. 1070835	EAN 6 411501 512765
Height: 45,6cm	Length: 5,3cm	Width: 8,3cm	Weight: 0,31kg	Retailbox: 6	Oldart.no. -	

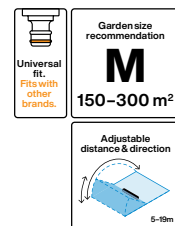

- Ideal for even watering of M-sized gardens and lawns.
- Intuitive controls adjust distance and direction.
- Easy, compact storage thanks to pivoting leg, easy cleaning.
- Coverage max. 15m - 19m (285m²).
- Universal quick connector, works with other brands.

Pulsating Sprinkler, tripod base, On/Off					Art.no. 1027050	EAN 6 411501 510754
Height: 23,7cm	Length: 9,2cm	Width: 24,5cm	Weight: 0,60kg	Retailbox: 4	Oldart.no. -	



- Innovative on/off valve stops water flow, allowing you to stay dry while making adjustments.
- Durable metal head has easy-to-adjust distance control, spray pattern control and rotation control to accurately water any area of your garden.
- Adjust coverage diameter up to Ø 26 m.
- Durable tripod base is ideal for hard soil and includes hanging loop for storage.
- Universal fit – Fits with other brands.

Pulsating Sprinkler, spike base, On/Off					Art.no. 1027029	EAN 6 411501 510747
Height: 35,5cm	Length: 11,2cm	Width: 18,5cm	Weight: 0,48kg	Retailbox: 4	Oldart.no. -	



- Innovative on/off valve stops water flow, allowing you to stay dry while making adjustments.
- Durable metal head has easy-to-adjust distance control, spray pattern control and rotation control to accurately water any area of your garden.
- Adjust watering area up to Ø 26 m.
- Durable metal spiked base offers added stability.
- Universal fit – Fits with other brands.

Impulse Sprinkler, metal with wheels					Art.no. 1023656	EAN 6 411501 510280
Height: 23,5cm	Length: 8,0cm	Width: 25,5cm	Weight: 0,94kg	Retailbox: 6	Oldart.no. -	

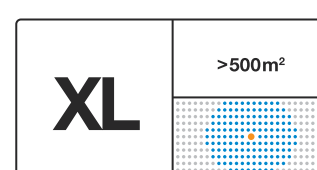

- Durable metal sprinkler has easy-to-adjust distance control, pattern control and rotation control to accurately water any area.
- Pattern adjusts from heavy stream to rain.
- Adjust spray distance up to Ø 26 m.
- Metal triangular base adds stability and wheels allow for easy movement around the garden.
- Universal fit – Fits with other brands.

Impulse Sprinkler, metal					Art.no. 1023658	EAN 6 411501 510303
Height: 36,0cm	Length: 6,6cm	Width: 19,5cm	Weight: 0,47kg	Retailbox: 6	Oldart.no. -	



- Durable metal sprinkler has easy-to-adjust distance control, pattern control and rotation control to accurately water any area.
- Pattern adjusts from heavy stream to rain.
- Adjust spray distance up to Ø 26 m.
- Metal spike base.
- Universal fit – Fits with other brands.

Whirling Sprinkler, metal with wheels					Art.no. 1023657	EAN 6 411501 510297
Height: 24,0cm	Length: 8,5cm	Width: 26,5cm	Weight: 0,84kg	Retailbox: 6	Oldart.no. -	



- Gentle, even, rain-like watering for small and targeted areas.
- Durable metal head.
- Triangular base adds stability and wheels allow for easy movement around the garden.
- Watering area up to Ø 13 m.
- Universal fit – Fits with other brands.

Stationary Sprinkler, round					Art.no. 1023663	EAN 6 411501 510358
Height: 17,5cm	Length: 4,2cm	Width: 11,5cm	Weight: 0,46kg	Retailbox: 6	Oldart.no. -	

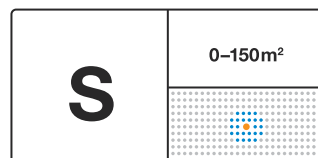

- Gentle, light, round spray pattern is perfect for small gardens and new grass seed.
- Round spray pattern with watering area up to 85 meters.
- Durable metal body.
- Rust resistant.
- Universal fit – Fits with other brands.

Stationary Sprinkler, square					Art.no. 1023664	EAN 6 411501 510365
Height: 17,5cm	Length: 4,2cm	Width: 11,5cm	Weight: 0,48kg	Retailbox: 6	Oldart.no. -	

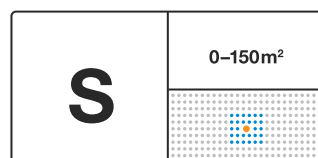

- Gentle, light, square spray pattern is perfect for small gardens and new grass seed.
- Square spray pattern with watering area up to 9 x 9 meters.
- Durable metal body.
- Rust resistant.
- Universal fit – Fits with other brands.

X-series™ Oscillating Sprinklers

- Detachable cap for tube flushing
- Nozzle cleaning tool
- Pivoting leg for easy storage
- Durable and stable metal base
- Intuitive non-slip controls
- Infinitely adjustable flow control
- Easy-to-clean soft nozzles
- Extra large rust-free filter for extended cleaning interval
- Universal fit - fits with all quick connectors, also from other brands

Universal fit. Fits with other brands.

Spray Nozzles

Fiskars spray guns feature an ergonomic design adding stability to any watering task. Easy to use with a variety of different spray patterns, all of our spray guns also offer infinitely adjustable flow, as well as universal fit with watering products sold by other brands.

Comfort Spray Nozzles

Spray gun multi, Front control

Height: 21,0 cm Length: 9,0 cm Width: 19,2 cm Weight: 0,23 kg Retail box: 4

Art.no. 1065482

Oldart.no. -



- Features an ergonomic front control handle which offers infinitely adjustable flow and locks for extended use
- Rotate the exchangeable SoftGrip™ nozzle head to select a mist, shower, flat, rinse or jet pattern
- Resists damage due to frost and stays warmer than metal nozzles in cold temperatures
- Universal fit - fits with other brands

Spray gun 3-functional, Front control

Height: 20,0 cm Length: 5,6 cm Width: 20,0 cm Weight: 0,19 kg Retail box: 5

Art.no. 1065483

Oldart.no. -



- Features an ergonomic front control handle which offers infinitely adjustable flow and locks for extended use
- Rotate the exchangeable SoftGrip™ nozzle head to select a jet, mist or shower spray pattern
- Resists damage due to frost and stays warmer than metal nozzles in cold temperatures
- Universal fit - fits with other brands

Spray gun adjustable, Front control

Height: 20,0 cm Length: 3,7 cm Width: 20,6 cm Weight: 0,17 kg Retail box: 5

Art.no. 1065484

Oldart.no. -



- Features an ergonomic front control handle which offers infinitely adjustable flow and locks for extended use
- Rotate the exchangeable SoftGrip™ nozzle head to select a jet or rinse spray pattern
- Resists damage due to frost and stays warmer than metal nozzles in cold temperatures
- Universal fit - fits with other brands

Front control

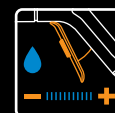

Front on/off trigger is ergonomic, infinitely adjustable and locks for extended use

Integrated permanent lock for easy extended use

Intuitively adjustable flow with ergonomic front trigger control

Comfortable SoftGrip™ handle

Exchangeable spray head with SoftGrip™

Universal fit - fits with all quick connectors, also from other brands



NEW! Comfort Spray Nozzles - Thumb control

Spray gun multi, Thumb control					Art.no. 1065485	EAN 6 411501 512413
Height: 21,0cm	Length: 19,2cm	Width: 9,0cm	Weight: 0,21kg	Retailbox: 4	Oldart.no. -	

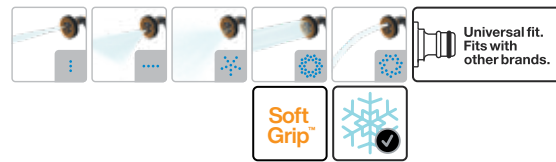

- Features an ergonomic thumb control handle with infinitely adjustable water flow
- Rotate the exchangeable SoftGrip™ nozzle head to select a mist, shower, flat, rinse or jet pattern
- Resists damage due to frost and stays warmer than metal nozzles in cold temperatures
- Universal fit – fits with other brands

Spray gun 3-functional, Thumb control					Art.no. 1065486	EAN 6 411501 512420
Height: 20,0cm	Length: 20,0cm	Width: 5,6cm	Weight: 0,17kg	Retailbox: 5	Oldart.no. -	



- Features an ergonomic thumb control handle with infinitely adjustable water flow
- Rotate the exchangeable SoftGrip™ nozzle head to select a jet, mist or shower spray pattern
- Resists damage due to frost and stays warmer than metal nozzles in cold temperatures
- Universal fit – fits with other brands

Spray gun adjustable, Thumb control					Art.no. 1065487	EAN 6 411501 512437
Height: 20,0cm	Length: 20,6cm	Width: 4,0cm	Weight: 0,15kg	Retailbox: 5	Oldart.no. -	



- Features an ergonomic thumb control handle with infinitely adjustable water flow
- Rotate the exchangeable SoftGrip™ nozzle head to select a jet or rinse spray pattern
- Resists damage due to frost and stays warmer than metal nozzles in cold temperatures
- Universal fit – fits with other brands

Thumb control



Thumb on/off flow control is ergonomic and infinitely adjustable

Exchangeable spray head with SoftGrip™



Infinitely adjustable flow and ergonomic thumb control

Comfortable SoftGrip™ handle

Universal fit, fits with all type of connectors and other brands

Watering Wands & Nozzles

Watering wand 3-functional, Front control					Art.no. 1065488	EAN 6 411501 512444
Height: 88,8cm	Length: 5,6cm	Width: 13,1cm	Weight: 0,47kg	Retailbox: 4	Oldart.no. -	

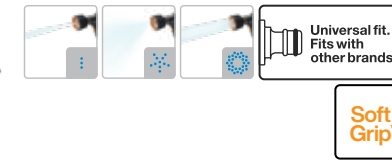

- Features an ergonomic front control handle which offers infinitely adjustable flow and locks for extended use
- Durable integrated aluminium shaft and 180° pivoting head
- Rotate the exchangeable SoftGrip™ nozzle head to select a jet, mist or shower spray pattern
- Resists damage due to frost and stays warmer than metal nozzles in cold temperatures
- Universal fit – fits with other brands

Watering wand adjustable, Front control					Art.no. 1065489	EAN 6 411501 512451
Height: 78,5cm	Length: 3,7cm	Width: 12,3cm	Weight: 0,37kg	Retailbox: 4	Oldart.no. -	

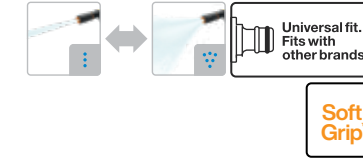

- Features an ergonomic front control handle which offers infinitely adjustable flow and locks for extended use
- Durable integrated aluminium shaft
- Rotate the exchangeable SoftGrip™ nozzle head to select a jet or rinse spray pattern
- Resists damage due to frost and stays warmer than metal nozzles in cold temperatures
- Universal fit – fits with other brands



Watering Wands & Nozzles

Multi gun, thumb control + Hose connect 13mm, STOP					Art.no. 1065492	EAN 6 411501 512482
Height: 20,0cm	Length: 18,8cm	Width: 9,0cm	Weight: 0,24kg	Retailbox: 4	Oldart.no. -	



New

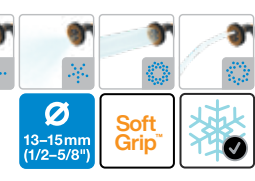

Universal fit. Fits with other brands.

Set includes:
 - 1x 1065485 CF Multi spray gun, thumb control
 - 1x 1027079 CF Quick Hose Connector 13-15mm (1/2-5/8") STOP

Adjustable gun, thumb control + Hose connect 13mm, STOP					Art.no. 1065493	EAN 6 411501 512499
Height: 20,0cm	Length: 20,6cm	Width: 4,0cm	Weight: 0,18kg	Retailbox: 5	Oldart.no. -	



New

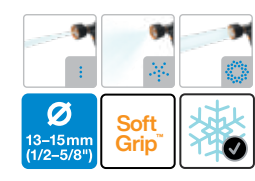

Universal fit. Fits with other brands.

Set includes:
 - 1x 1065487 CF Adjustable nozzle spray gun, thumb control
 - 1x 1027079 CF Quick Hose Connector 13-15mm (1/2-5/8") STOP

Adjustable gun, thumb control + Multi head					Art.no. 1065494	EAN 6 411501 512505
Height: 21,3cm	Length: 20,6cm	Width: 7,3cm	Weight: 0,27kg	Retailbox: 6	Oldart.no. -	



New

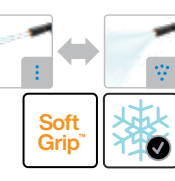

Universal fit. Fits with other brands.

Set includes:
 - 1x 1065487 CF Adjustable nozzle spray gun, thumb control
 - 1x 1027079 FC/CF Multi nozzle/wand head

Hose Nozzle					Art.no. 1027088	EAN 6 411501 511133
Height: 15,8cm	Length: 6,8cm	Width: 3,6cm	Weight: 0,06kg	Retailbox: 8	Oldart.no. -	





Universal fit. Fits with other brands.

- Smoothly adjustable spray pattern.
- Rotate the SoftGrip™ nozzle to select jet or rinse spray pattern.
- Resists damage due to frost and stays warmer than metal nozzles in cold temperatures.
- Universal fit – Fits with other brands.

Solid™ Spray Nozzles

Solid™ Spray gun, multi					Art.no. 1070836	EAN 6 411501 512772
Height: 21,0cm	Length: 9,0cm	Width: 19,2cm	Weight: 0,23kg	Retailbox: 4	Oldart.no. -	



New

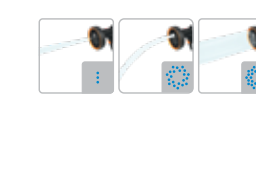

Universal fit. Fits with other brands.

- Lightweight handle with front flow control which locks for comfortable extended use.
- Rotate the non-slip nozzle head to select a shower, flat or jet spray pattern.
- Frost resistant when drained and handle stays warmer than metal handles in cold temperatures.
- Universal fit – fits with other brands.

Solid™ Spray gun, shower					Art.no. 1070837	EAN 6 411501 512789
Height: 20,0cm	Length: 5,6cm	Width: 20,0cm	Weight: 0,18kg	Retailbox: 5	Oldart.no. -	



New



Universal fit. Fits with other brands.

- Lightweight handle with front flow control which locks for comfortable extended use.
- Gentle shower pattern is ideal for rain-like watering.
- Frost resistant when drained and handle stays warmer than metal handles in cold temperatures.
- Universal fit – fits with other brands.

Solid™ Spray gun, adjustable					Art.no. 1070838	EAN 6 411501 512796
Height: 20,0cm	Length: 3,7cm	Width: 20,6cm	Weight: 0,18kg	Retailbox: 5	Oldart.no. -	



New



Universal fit. Fits with other brands.

- Lightweight handle with front flow control which locks for comfortable extended use.
- Rotate the non-slip nozzle head to adjust from jet-shower to rinse spray pattern.
- Frost resistant when drained and handle stays warmer than metal handles in cold temperatures.
- Universal fit – fits with other brands.

Nozzle Sets

Hose Nozzle - Basic Set					Art.no. 1027091	EAN 6 411501 511164
Height: 22,0cm	Length: 4,9cm	Width: 9,8cm	Weight: 0,15kg	Retailbox: 4	Oldart.no. -	



Set includes:

- 1x 1027051 Tap Connector, Multi
- 1x 1027072 Quick Hose Connector 13-15 mm (1/2-5/8"), FLOW
- 1x 1027079 Quick Hose Connector 13-15 mm (1/2-5/8"), STOP
- 1x 1027088 CF Hose Nozzle

1/2, 3/4 & 1" | 13-15mm (1/2-5/8") | Universal fit. Fits with other brands.

Solid™ Hose Nozzle - Basic Set					Art.no. 1027090	EAN 6 411501 511157
Height: 22,0cm	Length: 4,3cm	Width: 9,8cm	Weight: 0,15kg	Retailbox: 4	Oldart.no. -	



Set includes:

- 1x 1027057 Tap Connector - G1/2"
- 1x 1027076 Solid Quick Hose Connector 13-15 mm (1/2-5/8"), FLOW
- 1x 1027083 Solid Quick Hose Connector 13-15 mm (1/2-5/8"), STOP
- 1x 1027088 CF Hose Nozzle

G 1/2" (21mm) | 13-15mm (1/2-5/8") | Universal fit. Fits with other brands.

Comfort Precision Watering starter set					Art.no. 1070830	EAN 6 411501 512710
Height: 26,9cm	Length: 7,9cm	Width: 18,7cm	Weight: 0,56kg	Retailbox: 4	Oldart.no. -	



• Ideal for precise watering of flower beds, grass patches, saplings and any other task that requires very targeted watering.

• Includes an adapter, a spike sprinkler stand, a spray gun handle and a multi-function nozzle head.

• Use as a precise stationary sprinkler or as a regular, multi-function spray gun for meeting a variety of watering needs.

• On/off/flow control valve on spike sprinkler stand provides additional watering control.

Precision Watering Starter set

The set includes

- Sprinkler stand
- Adapter for easy connection
- Nozzle handle, front control
- Spray gun head, multi

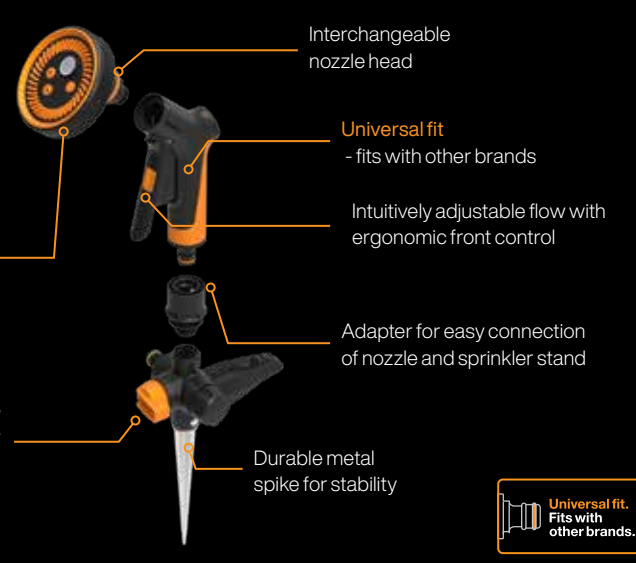

Interchangeable nozzle head

Universal fit - fits with other brands

Intuitively adjustable flow with ergonomic front control

Adapter for easy connection of nozzle and sprinkler stand

Durable metal spike for stability

On/off -flow control valve on sprinkler stand for additional control

Rotate the exchangeable non-slip nozzle head to select mist, shower, flat, rinse or jet pattern

Universal fit. Fits with other brands.

Mix & Match

Nozzle/wand handle, Front control					Art.no. 1065490	EAN 6 411501 512468
Height: 22,0cm	Length: 3,7cm	Width: 10cm	Weight: 0,12kg	Retailbox: 4	Oldart.no. -	



Soft Grip | Universal fit. Fits with other brands.

- Fits with Fiskars nozzle items 1067193, 1067194, 1067195, 1059236, 1059237, 1059238, 1065484, 1065483, 1065482, 1065487, 1065486, 1065485, 1065489 and 1065488.
- Ergonomic front-control handle which offers infinitely adjustable flow and locks for extended use
- Resists damage due to frost and stays warmer than metal handles in cold temperatures
- Universal fit - fits with other brands

Nozzle/wand handle, Thumb control					Art.no. 1065491	EAN 6 411501 512475
Height: 23,0cm	Length: 7,0cm	Width: 4,0cm	Weight: 0,10kg	Retailbox: 6	Oldart.no. -	



Soft Grip | Universal fit. Fits with other brands.

- Fits with Fiskars nozzle items 1067193, 1067194, 1067195, 1059236, 1059237, 1059238, 1065484, 1065483, 1065482, 1065487, 1065486, 1065485, 1065489 and 1065488.
- Ergonomic thumb control handle with infinitely adjustable water flow
- Resists damage due to frost and stays warmer than metal handles in cold temperatures
- Universal fit - fits with other brands

Spray gun head, multi					Art.no. 1059238	EAN 6 411501 512017
Height: 13,6cm	Length: 7,2cm	Width: 11cm	Weight: 0,13kg	Retailbox: 6	Oldart.no. -	



Soft Grip

- Multi SoftGrip™ nozzle head with mist, shower, flat, rinse or jet pattern.
- Fits with Fiskars nozzles and wands 1065484, 1065483, 1065482, 1065487, 1065486, 1065485, 1065489, 1065488, 1065490, 1065491, 1067193, 1067194, 1067195, 1067196.

Spray gun head, 3-functional					Art.no. 1059237	EAN 6 411501 512000
Height: 10,8cm	Length: 7,8cm	Width: 7cm	Weight: 0,08kg	Retailbox: 6	Oldart.no. -	



Soft Grip

- 3-function SoftGrip™ nozzle head with jet, shower or mist pattern.
- Fits with Fiskars nozzles and wands 1065484, 1065483, 1065482, 1065487, 1065486, 1065485, 1065489, 1065488, 1065490, 1065491, 1067193, 1067194, 1067195, 1067196.

Spray gun head, adjustable nozzle					Art.no. 1059236	EAN 6 411501 511997
Height: 10,6cm	Length: 5,1cm	Width: 5,1cm	Weight: 0,06kg	Retailbox: 8	Oldart.no. -	



Soft Grip

- Adjustable SoftGrip™ nozzle head with jet or rinse spray pattern.
- Fits with Fiskars nozzles and wands 1065484, 1065483, 1065482, 1065487, 1065486, 1065485, 1065489, 1065488, 1065490, 1065491, 1067193, 1067194, 1067195, 1067196.

Connectors



All you need from tap to plant

Universal fit

Already own watering products from other brands? No problem. Our watering products are designed to fit with other brands.

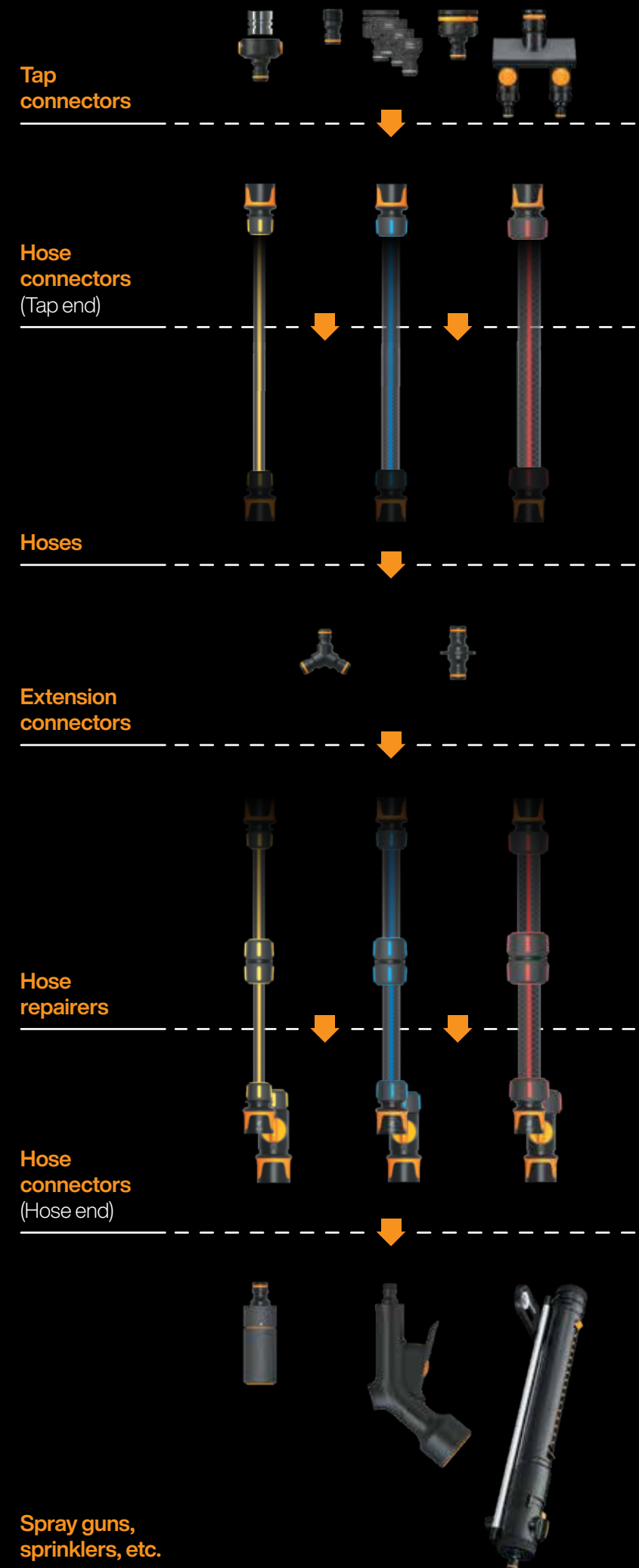

Spray guns, sprinklers, etc.

NEW! Connectors

Comfort Twin tap connector, On/Off					Art.no. 1070577	EAN 6 411501 512680
Height: 20,5cm	Length: 5,1cm	Width: 15,7cm	Weight: 0,22kg	Retailbox: 4	Oldart.no. -	



- Splits one water source into two connections with independent flow control valves.
- The quick connector ends can be screwed off for 3/4" connection possibility (e.g. timers).
- Fits 3 tap thread sizes: Ø 21 mm (G 1/2"), Ø 26.5 mm (G 3/4"), Ø 33.3 mm (G 1").
- Universal fit – fits with other brands.

Comfort 3-way tap connector, On/Off					Art.no. 1070578	EAN 6 411501 512697
Height: 20,5cm	Length: 5,1cm	Width: 22,2cm	Weight: 0,31kg	Retailbox: 4	Oldart.no. -	



- Splits one water source into three connections with independent flow control valves.
- The quick connector ends can be screwed off for 3/4" connection possibility (e.g. timers).
- Fits 3 tap thread sizes: Ø 21 mm (G 1/2"), Ø 26.5 mm (G 3/4"), Ø 33.3 mm (G 1").
- Universal fit – fits with other brands.

Comfort Precision Watering adapter set					Art.no. 1070579	EAN 6 411501 512703
Height: 13,2cm	Length: 4,2cm	Width: 6,8cm	Weight: 0,05kg	Retailbox: 8	Oldart.no. -	



- Ideal for precise watering of flower beds, grass patches, saplings and any other task that requires very targeted watering.
- 2-piece set connects watering tools to sprinkler stands, creating precise stationary sprinklers.
- Includes universal quick connector adapter with 1/2" thread that connects to spray guns and most standard sprinkler stands, including spike and sled models.
- Also includes Fiskars special adapter to attach to Fiskars nozzles, wands or pivot connectors.

New tap connectors

Comfort 3-way tap connectors

- Save time and effort
- Are easy to install and use
- Enables additional watering control
- Are compatible with timers

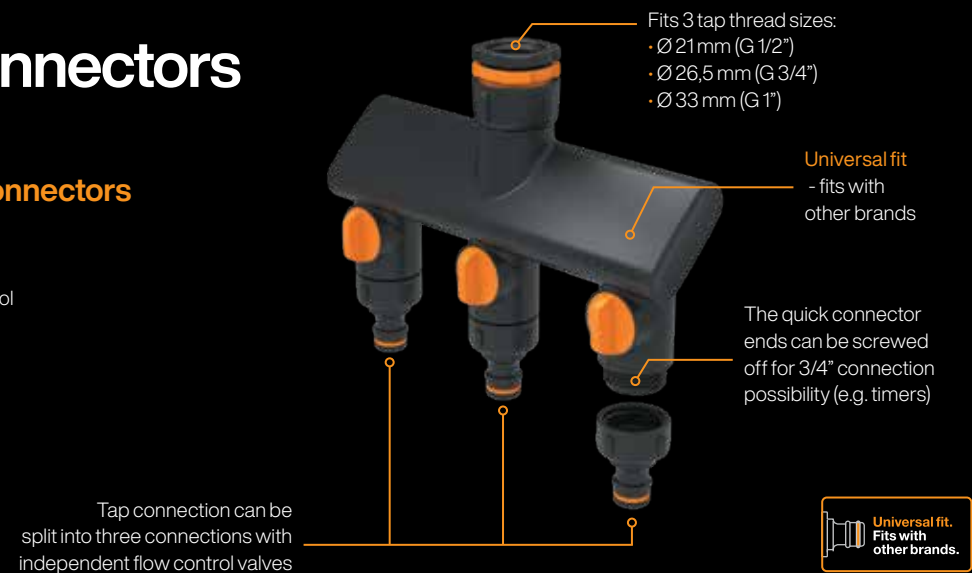

Connectors - FLOW

FiberComp™ Quick Connector, 13-15mm (1/2-5/8") FLOW					Art.no. 1054786	EAN 6 411501 511737
Height: 11,6cm	Length: 6,8cm	Width: 3,9cm	Weight: 0,03kg	Retailbox: 8	Oldart.no. -	



Ø 13-15mm (1/2-5/8")

Universal fit. Fits with other brands.

WARRANTY 5 YEARS

2X MORE DURABLE

FiberComp™

- Lightweight FiberComp™ construction, featuring 2x more durable material.
- Frost resistant for all-weather durability.
- Comfortable grip, even in cold weather, compared to metal watering parts.
- Colour coded for easy connecting to Fiskars hoses.
- Universal fit – Fits with other brands.

Quick Connector, 13-15mm (1/2-5/8") FLOW					Art.no. 1027072	EAN 6 411501 510976
Height: 11,6cm	Length: 6,8cm	Width: 3,9cm	Weight: 0,03kg	Retailbox: 8	Oldart.no. -	



Ø 13-15mm (1/2-5/8")

Universal fit. Fits with other brands.

reddot award 2019 winner

- Quick exchange of watering nozzles, wands, sprinklers and other hose ends.
- SoftGrip™ touchpoints ensure secure handling, even when wet.
- Comfortable grip, even in cold weather, compared to metal watering parts.
- Colour coded for easy connecting to Fiskars hoses.
- Universal fit – Fits with other brands.

FiberComp™ Quick Connector, 19mm (3/4") FLOW					Art.no. 1054787	EAN 6 411501 511744
Height: 11,6cm	Length: 6,8cm	Width: 4,6cm	Weight: 0,04kg	Retailbox: 8	Oldart.no. -	



Ø 19mm (3/4")

Universal fit. Fits with other brands.

WARRANTY 5 YEARS

2X MORE DURABLE

FiberComp™

- Lightweight FiberComp™ construction, featuring 2x more durable material.
- Frost resistant for all-weather durability.
- Comfortable grip, even in cold weather, compared to metal watering parts.
- Colour coded for easy connecting to Fiskars hoses.
- Universal fit – Fits with other brands.

Quick Connector, 19mm (3/4") FLOW					Art.no. 1027074	EAN 6 411501 510990
Height: 11,6cm	Length: 6,8cm	Width: 4,6cm	Weight: 0,04kg	Retailbox: 8	Oldart.no. -	



Ø 19mm (3/4")

Universal fit. Fits with other brands.

reddot award 2019 winner

- Quick exchange of watering nozzles, wands, sprinklers and other hose ends.
- SoftGrip™ touchpoints ensure secure handling, even when wet.
- Comfortable grip, even in cold weather, compared to metal watering parts.
- Colour coded for easy connecting to Fiskars hoses.
- Universal fit – Fits with other brands.

Quick Connector, 9mm (3/8") FLOW					Art.no. 1027071	EAN 6 411501 510969
Height: 11,6cm	Length: 6,8cm	Width: 3,9cm	Weight: 0,03kg	Retailbox: 8	Oldart.no. -	



Ø 9mm (3/8")

Universal fit. Fits with other brands.

reddot award 2019 winner

- Quick exchange of watering nozzles, wands, sprinklers and other hose ends.
- SoftGrip™ touchpoints ensure secure handling, even when wet.
- Comfortable grip, even in cold weather compared to metal watering parts.
- Colour coded for easy connecting to Fiskars hoses.
- Universal fit – Fits with other brands.

Connectors - STOP

FiberComp™ Quick Connector, 13-15mm (1/2-5/8") STOP					Art.no. 1054789	EAN 6 411501 511751
Height: 11,6cm	Length: 6,8cm	Width: 3,9cm	Weight: 0,03kg	Retailbox: 8	Oldart.no. -	

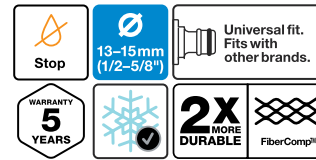

- Internal stop mechanism stops water flow for exchange of water nozzles, wands, sprinklers and other hose ends.
- Lightweight FiberComp™ construction, featuring 2x more durable material.
- Frost resistant for all-weather durability.
- Comfortable grip, even in cold weather, compared to metal watering parts.
- Colour coded for easy connecting to Fiskars hoses.
- Universal fit – Fits with other brands.

Quick Connector, 13-15mm (1/2-5/8") STOP					Art.no. 1027079	EAN 6 411501 511041
Height: 11,6cm	Length: 6,8cm	Width: 3,9cm	Weight: 0,03kg	Retailbox: 8	Oldart.no. -	

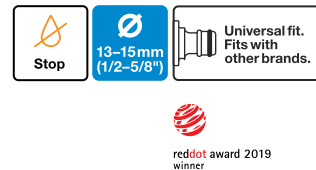

- Internal stop mechanism stops water flow for exchange of water nozzles, wands, sprinklers and other hose ends.
- SoftGrip™ touchpoints ensure secure handling, even when wet.
- Comfortable grip, even in cold weather, compared to metal watering parts.
- Colour coded for easy connecting to Fiskars hoses.
- Universal fit – Fits with other brands.

FiberComp™ Quick Connector, 19mm (3/4") STOP					Art.no. 1054790	EAN 6 411501 511768
Height: 11,6cm	Length: 6,8cm	Width: 4,6cm	Weight: 0,04kg	Retailbox: 8	Oldart.no. -	

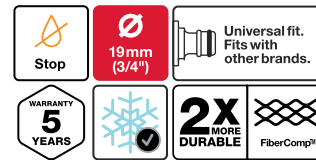

- Internal stop mechanism stops water flow for exchange of water nozzles, wands, sprinklers and other hose ends.
- Lightweight FiberComp™ construction, featuring 2x more durable material.
- Frost resistant for all-weather durability.
- Comfortable grip, even in cold weather, compared to metal watering parts.
- Colour coded for easy connecting to Fiskars hoses.
- Universal fit – Fits with other brands.

Quick Connector, 19mm (3/4") STOP					Art.no. 1027081	EAN 6 411501 511065
Height: 11,6cm	Length: 6,8cm	Width: 4,6cm	Weight: 0,04kg	Retailbox: 8	Oldart.no. -	

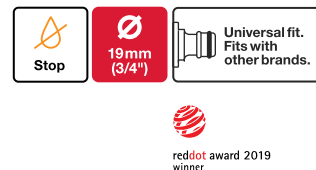

- Internal stop mechanism stops water flow for exchange of water nozzles, wands, sprinklers and other hose ends.
- SoftGrip™ touchpoints ensure secure handling, even when wet.
- Comfortable grip, even in cold weather, compared to metal watering parts.
- Colour coded for easy connecting to Fiskars hoses.
- Universal fit – Fits with other brands.

Quick Connector, 9mm (3/8") STOP					Art.no. 1027078	EAN 6 411501 511034
Height: 11,6cm	Length: 6,8cm	Width: 3,9cm	Weight: 0,03kg	Retailbox: 8	Oldart.no. -	

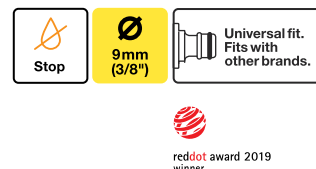

- Internal stop mechanism stops water flow for exchange of water nozzles, wands, sprinklers and other hose ends.
- SoftGrip™ touchpoints ensure secure handling, even when wet.
- Comfortable grip, even in cold weather, compared to metal watering parts.
- Colour coded for easy connecting to Fiskars hoses.
- Universal fit – Fits with other brands.

Hose Connectors - On/Off

Hose Connector, On/Off 13-15mm (1/2-5/8")					Art.no. 1027086	EAN 6 411501 511119
Height: 15,8cm	Length: 6,8cm	Width: 4,4cm	Weight: 0,07kg	Retailbox: 8	Oldart.no. -	

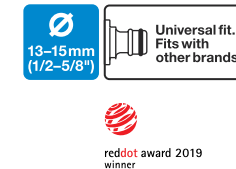

- On/off valve cuts water flow for exchange of water nozzles, wands, sprinklers and other hose ends.
- SoftGrip™ touchpoints ensure secure handling, even when wet.
- Comfortable grip, even in cold weather, compared to metal watering parts.
- Colour coded for easy connecting to Fiskars hoses.
- Universal fit – Fits with other brands.

Hose Connector, On/Off 19mm (3/4")					Art.no. 1027087	EAN 6 411501 511126
Height: 15,8cm	Length: 6,8cm	Width: 4,6cm	Weight: 0,08kg	Retailbox: 8	Oldart.no. -	

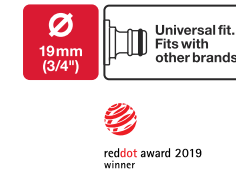

- ON/OFF valve cuts water flow for exchange of water nozzles, wands, sprinklers and other hose ends.
- SoftGrip™ touchpoints ensure secure handling, even when wet.
- Comfortable grip, even in cold weather, compared to metal watering parts.
- Colour coded for easy connecting to Fiskars hoses.
- Universal fit – Fits with other brands.

Hose Connector, On/Off 9mm (3/8")					Art.no. 1027085	EAN 6 411501 511102
Height: 15,8cm	Length: 6,8cm	Width: 4,4cm	Weight: 0,06kg	Retailbox: 8	Oldart.no. -	

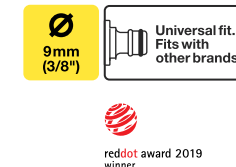

- On/off valve cuts water flow for exchange of water nozzles, wands, sprinklers and other hose ends.
- SoftGrip™ touchpoints ensure secure handling, even when wet.
- Comfortable grip, even in cold weather, compared to metal watering parts.
- Colour coded for easy connecting to Fiskars hoses.
- Universal fit – Fits with other brands.

Hose Repairers

FiberComp™ Hose Repairer, 13-15mm (1/2-5/8")					Art.no. 1054784	EAN 6 411501 511713
Height: 11,6cm	Length: 6,8cm	Width: 3,6cm	Weight: 0,02kg	Retailbox: 10	Oldart.no. -	



Universal fit. Fits with other brands.
 13-15mm (1/2-5/8")
 WARRANTY 5 YEARS
 2X MORE DURABLE
 Frost resistant

- Lightweight FiberComp™ construction, featuring 2x more durable material.
- Frost resistant for all-weather durability.
- Comfortable grip, even in cold weather, compared to metal watering parts.
- Colour coded for easy connecting to Fiskars hoses.
- Universal fit – Fits with other brands.

Hose Repairer, 13-15mm (1/2-5/8")					Art.no. 1027064	EAN 6 411501 510891
Height: 11,6cm	Length: 6,8cm	Width: 3,6cm	Weight: 0,02kg	Retailbox: 10	Oldart.no. -	

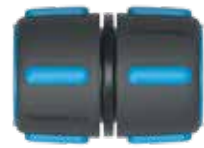

Universal fit. Fits with other brands.
 13-15mm (1/2-5/8")
 WARRANTY 5 YEARS
 2X MORE DURABLE
 Frost resistant
 red dot award 2019 winner

- SoftGrip™ touchpoints ensure secure handling, even when wet.
- Comfortable grip, even in cold weather compared to metal watering parts.
- Colour coded for easy connecting to Fiskars hoses.
- Universal fit – Fits with other brands.

FiberComp™ Repairer, 19mm (3/4")					Art.no. 1054785	EAN 6 411501 511720
Height: 11,6cm	Length: 6,8cm	Width: 4,5cm	Weight: 0,03kg	Retailbox: 8	Oldart.no. -	



Universal fit. Fits with other brands.
 19mm (3/4")
 WARRANTY 5 YEARS
 2X MORE DURABLE
 Frost resistant

- Lightweight FiberComp™ construction, featuring 2x more durable material.
- Frost resistant for all-weather durability.
- Comfortable grip, even in cold weather, compared to metal watering parts.
- Colour coded for easy connecting to Fiskars hoses.
- Universal fit – Fits with other brands.

Hose Repairer, 19mm (3/4")					Art.no. 1027066	EAN 6 411501 510914
Height: 11,6cm	Length: 6,8cm	Width: 4,5cm	Weight: 0,03kg	Retailbox: 8	Oldart.no. -	



Universal fit. Fits with other brands.
 19mm (3/4")
 WARRANTY 5 YEARS
 2X MORE DURABLE
 Frost resistant
 red dot award 2019 winner

- SoftGrip™ touchpoints ensure secure handling, even when wet.
- Comfortable grip, even in cold weather compared to metal watering parts.
- Colour coded for easy connecting to Fiskars hoses.
- Universal fit – Fits with other brands.

Hose Repairer, 9mm (3/8")					Art.no. 1027063	EAN 6 411501 510884
Height: 11,6cm	Length: 6,8cm	Width: 2,9cm	Weight: 0,02kg	Retailbox: 12	Oldart.no. -	

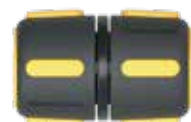

Universal fit. Fits with other brands.
 9mm (3/8")
 WARRANTY 5 YEARS
 2X MORE DURABLE
 Frost resistant
 red dot award 2019 winner

- SoftGrip™ touchpoints ensure secure handling, even when wet.
- Comfortable grip, even in cold weather, compared to metal watering parts.
- Colour coded for easy connecting to Fiskars hoses.
- Universal fit – Fits with other brands.

Tap Connectors

FiberComp™ Tap Connector, multi					Art.no. 1027056	EAN 6 411501 510815
Height: 11,6cm	Length: 6,8cm	Width: 4,2cm	Weight: 0,03kg	Retailbox: 8	Oldart.no. -	



Universal fit. Fits with other brands.
 1/2, 3/4 & 1"
 WARRANTY 5 YEARS
 2X MORE DURABLE
 Frost resistant
 red dot award 2019 winner

- Tap connector provides water-tight seal from water source to hose.
- FiberComp™ is 2x more durable than standard plastic connectors.
- Includes three thread sizes to fit most common faucets, Ø 21mm (G 1/2"), Ø 265 mm (G 3/4") and Ø 333 mm (G 1").
- Easy-to-handle, ergonomic design.
- Universal fit – Fits with other brands.

Tap Connector, multi					Art.no. 1027051	EAN 6 411501 510761
Height: 11,6cm	Length: 6,8cm	Width: 4,2cm	Weight: 0,02kg	Retailbox: 8	Oldart.no. -	



Universal fit. Fits with other brands.
 1/2, 3/4 & 1"

- Tap connector provides secure seal from hose to water source.
- Includes three thread sizes to fit most common faucets, Ø 21mm (G 1/2"), Ø 265 mm (G 3/4") and Ø 333 mm (G 1").
- Easy-to-twist design.
- Universal fit – Fits with other brands.

FiberComp™ Tap Connector G1/2" (21mm)					Art.no. 1027053	EAN 6 411501 510785
Height: 11,6cm	Length: 6,8cm	Width: 3,0cm	Weight: 0,01kg	Retailbox: 12	Oldart.no. -	



Universal fit. Fits with other brands.
 1/2"
 WARRANTY 5 YEARS
 2X MORE DURABLE
 Frost resistant
 red dot award 2019 winner

- Tap connector provides water-tight seal from water source to hose.
- FiberComp™ is 2x more durable than standard plastic connectors.
- Fits Ø 21mm (G 1/2") faucets.
- Easy-to-handle, ergonomic design.
- Universal fit – Fits with other brands.

FiberComp™ Tap Connector G3/4" (26.5mm)					Art.no. 1027054	EAN 6 411501 510792
Height: 11,6cm	Length: 6,8cm	Width: 3,5cm	Weight: 0,01kg	Retailbox: 10	Oldart.no. -	



Universal fit. Fits with other brands.
 3/4"
 WARRANTY 5 YEARS
 2X MORE DURABLE
 Frost resistant
 red dot award 2019 winner

- Tap connector provides water-tight seal from water source to hose.
- FiberComp™ is 2x more durable than standard plastic connectors.
- Fits Ø 265 mm (G 3/4") faucets.
- Easy-to-handle, ergonomic design.
- Universal fit – Fits with other brands.

FiberComp™ Tap Connector G1" (33.3mm)					Art.no. 1027055	EAN 6 411501 510808
Height: 11,6cm	Length: 6,8cm	Width: 4,2cm	Weight: 0,01kg	Retailbox: 8	Oldart.no. -	



Universal fit. Fits with other brands.
 1"
 WARRANTY 5 YEARS
 2X MORE DURABLE
 Frost resistant
 red dot award 2019 winner

- Tap connector provides water-tight seal from water source to hose.
- FiberComp™ is 2x more durable than standard plastic connectors.
- Fits Ø 333 mm (G 1") faucets.
- Easy-to-handle, ergonomic design.
- Universal fit – Fits with other brands.

Twin tap Connector, multi					Art.no. 1027061	EAN 6 411501 510860
Height: 15,8cm	Length: 11,8cm	Width: 4,5cm	Weight: 0,09kg	Retailbox: 8	Oldart.no. -	



- Tap connector provides secure seal from two hoses to water source.
- Individual flow control valves allow you turn water pressure on or off independently.
- Includes three thread sizes to fit most common faucets, Ø 21mm (G 1/2"), Ø 265 mm (G 3/4") and Ø 333 mm (G 1").
- Easy-to-twist design.
- Universal fit – Fits with other brands.

Tap Connector, indoor M22x1/M24x1					Art.no. 1027062	EAN 6 411501 510877
Height: 13,6cm	Length: 6,8cm	Width: 4,0cm	Weight: 0,05kg	Retailbox: 8	Oldart.no. -	



- Durable locking system provides a secure connection from hose to indoor faucet.
- Quick release allows you disconnect the hose by pressing two buttons.
- Includes M22 female and M24 male thread metal adaptors.
- Easy to install.
- Universal fit – Fits with other brands.

Tap Connector, male thread G1/2" (21mm)					Art.no. 1027060	EAN 6 411501 510853
Height: 11,6cm	Length: 6,8cm	Width: 2,1cm	Weight: 0,01kg	Retailbox: 10	Oldart.no. -	



- Durable for everyday use to connect any Ø 21mm (G 1/2") female thread.
- Suited for the garden or indoors.
- Universal fit – Fits with other brands.

Extension Connector					Art.no. 1027068	EAN 6 411501 510938
Height: 11,6cm	Length: 6,8cm	Width: 3,2cm	Weight: 0,02kg	Retailbox: 10	Oldart.no. -	



- For connecting hoses of differing diameters.
- Works with all types and sizes of Quick Hose Connectors.
- Universal fit – Fits with other brands.

3-way Connector					Art.no. 1027070	EAN 6 411501 510952
Height: 11,6cm	Length: 6,8cm	Width: 2,0cm	Weight: 0,02kg	Retailbox: 12	Oldart.no. -	



- Directs one watering supply to 2 separate hoses.
- Works with all types and sizes of Quick Hose Connectors.
- Universal fit – Fits with other brands.

Connectors in shelf ready boxes

Quick Connector, 13-15mm (1/2-5/8") LB (min 30)					Art.no. 1027073	EAN 6 411501 510983
Height: 6,4cm	Length: 3,9cm	Width: 3,9cm	Weight: 0,03kg	Retailbox: 30	Oldart.no. -	

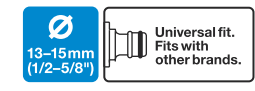

Universal fit. Fits with other brands.



- Comes in loose box of 1027072 Quick hose connector, 13-15mm (1/2-5/8") FLOW 30 pc without product card, but with EAN sticker.
- Universal fit – Fits with other brands.
- Please note! The black retail box must be ordered separately, shipped as a set of 4 pcs (flatpacked), Product code: 1027677, EAN code: 6411501511386.

Quick Connector, 13-15mm (1/2-5/8") LB (min 30)					Art.no. 1027076	EAN 6 411501 511010
Height: 6,4cm	Length: 3,9cm	Width: 3,9cm	Weight: 0,03kg	Retailbox: 30	Oldart.no. -	



Universal fit. Fits with other brands.

- Quick exchange of watering nozzles, wands, sprinklers and other hose ends.
- For hoses with Ø 13-15mm (1/2-5/8").
- Comes in loose box of 30 pc without product card, but with EAN sticker.
- Universal fit – Fits with other brands.
- Please note! The black retail box must be ordered separately, shipped as a set of 4 pcs (flatpacked), Product code: 1027677, EAN code: 6411501511386.

Quick Connector, 19mm (3/4") LB (min 30)					Art.no. 1027075	EAN 6 411501 511003
Height: 6,8cm	Length: 4,6cm	Width: 4,6cm	Weight: 0,04kg	Retailbox: 30	Oldart.no. -	



Universal fit. Fits with other brands.



- Comes in loose box of 1027074 Quick hose connector, 19mm (3/4") FLOW 30 pc without product card, but with EAN sticker.
- Universal fit – Fits with other brands.
- Please note! The black retail box must be ordered separately, shipped as a set of 4 pcs (flatpacked), Product code: 1027677, EAN code: 6411501511386.

Quick Connector, 19mm (3/4") LB (min 30)					Art.no. 1027077	EAN 6 411501 511027
Height: 6,8cm	Length: 4,6cm	Width: 4,6cm	Weight: 0,04kg	Retailbox: 30	Oldart.no. -	



Universal fit. Fits with other brands.

- Quick exchange of watering nozzles, wands, sprinklers and other hose ends.
- For hoses with Ø 19mm (3/4").
- Comes in loose box of 30 pc without product card, but with EAN sticker.
- Universal fit – Fits with other brands.
- Please note! The black retail box must be ordered separately, shipped as a set of 4 pcs (flatpacked), Product code: 1027677, EAN code: 6411501511386.

Quick Connector, 13-15mm (1/2-5/8") STOP LB (min 30)					Art.no. 1027080	EAN 6 411501 511058
Height: 6,4cm	Length: 4,6cm	Width: 3,9cm	Weight: 0,03kg	Retailbox: 30	Oldart.no. -	



Universal fit. Fits with other brands.



- Comes in loose box of 1027079 Quick hose connector, 13-15mm (1/2-5/8") STOP 30 pc without product card, but with EAN sticker.
- Universal fit – Fits with other brands.
- Please note! The black retail box must be ordered separately, shipped as a set of 4 pcs (flatpacked), Product code: 1027677, EAN code: 6411501511386.

Quick Connector, 13-15mm (1/2-5/8") STOP LB (min 30)					Art.no. 1027083	EAN 
Height: 6,4cm	Length: 3,9cm	Width: 3,9cm	Weight: 0,03kg	Retailbox: 30	Oldart.no. -	



x30



13-15mm (1/2-5/8")



Universal fit. Fits with other brands.

- Internal stop mechanism stops water flow for exchange of water nozzles, wands, sprinklers and other hose ends.
- For hoses with Ø 13-15 mm (1/2-5/8").
- Comes in loose box of 30 pc without product card, but with EAN sticker.
- Universal fit – Fits with other brands.

Please note! The black retail box must be ordered separately, shipped as a set of 4 pcs (flatpacked), Product code: 1027677, EAN code: 6411501511386.

Quick Connector, 19mm (3/4") STOP LB (min 30)					Art.no. 1027082	EAN 
Height: 6,8cm	Length: 4,6cm	Width: 4,6cm	Weight: 0,04kg	Retailbox: 30	Oldart.no. -	



x30



19mm (3/4")



Universal fit. Fits with other brands.

- Comes in loose box of 1027081 Quick hose connector, 19mm (3/4") STOP 30 pc without product card, but with EAN sticker.
- Universal fit – Fits with other brands.

Please note! The black retail box must be ordered separately, shipped as a set of 4 pcs (flatpacked), Product code: 1027677, EAN code: 6411501511386.

Quick Connector, 19mm (3/4") STOP LB (min 30)					Art.no. 1027084	EAN 
Height: 6,8cm	Length: 4,6cm	Width: 4,6cm	Weight: 0,04kg	Retailbox: 30	Oldart.no. -	



x30



19mm (3/4")



Universal fit. Fits with other brands.

- Internal stop mechanism stops water flow for exchange of water nozzles, wands, sprinklers and other hose ends.
- For hoses with Ø 19 mm (3/4").
- Comes in loose box of 30 pc without product card, but with EAN sticker.
- Universal fit – Fits with other brands.

Please note! The black retail box must be ordered separately, shipped as a set of 4 pcs (flatpacked), Product code: 1027677, EAN code: 6411501511386.

Hose Repairer, 13-15mm (1/2-5/8") LB (min 30)					Art.no. 1027065	EAN 
Height: 5,3cm	Length: 3,6cm	Width: 3,6cm	Weight: 0,02kg	Retailbox: 30	Oldart.no. -	



x30



13-15mm (1/2-5/8")



Universal fit. Fits with other brands.

- Comes in loose box of 1027064 Hose repairer, 13-15mm (1/2-5/8") 30 pc without product card, but with EAN sticker.
- Universal fit – Fits with other brands.

Please note! The black retail box must be ordered separately, shipped as a set of 4 pcs (flatpacked), Product code: 1027677, EAN code: 6411501511386.

Hose Repairer, 19mm (3/4") LB (min 30)					Art.no. 1027067	EAN 
Height: 5,9cm	Length: 4,5cm	Width: 4,5cm	Weight: 0,03kg	Retailbox: 30	Oldart.no. -	



x30



19mm (3/4")



Universal fit. Fits with other brands.

- Comes in loose box of 1027066 Hose repairer, 19mm (3/4") 30 pc without product card, but with EAN sticker.
- Universal fit – Fits with other brands.

Please note! The black retail box must be ordered separately, shipped as a set of 4 pcs (flatpacked), Product code: 1027677, EAN code: 6411501511386.

Tap Connector, multi LB (min 30)					Art.no. 1027052	EAN 
Height: 4,5cm	Length: 4,2cm	Width: 4,2cm	Weight: 0,03kg	Retailbox: 30	Oldart.no. -	



x30



1/2, 3/4 & 1"



Universal fit. Fits with other brands.

- Comes in loose box of 1027051 Tap connector, Multi 30 pc without product card, but with EAN sticker.
- Universal fit – Fits with other brands.

Please note! The black retail box must be ordered separately, shipped as a set of 4 pcs (flatpacked), Product code: 1027677, EAN code: 6411501511386.

Tap Connector G1/2" (21mm) LB (min 30)					Art.no. 1027057	EAN 
Height: 4,0cm	Length: 3,0cm	Width: 3,0cm	Weight: 0,01kg	Retailbox: 30	Oldart.no. -	



x30



1/2"



Universal fit. Fits with other brands.

- Tap connector provides water-tight seal from water source to hose.
- Fits Ø 21mm (G 1/2") faucets.
- Easy-to-twist design.
- Comes in loose box of 30 pc without product card, but with EAN sticker.
- Universal fit – Fits with other brands.

Please note! The black retail box must be ordered separately, shipped as a set of 4 pcs (flatpacked), Product code: 1027677, EAN code: 6411501511386.

Tap Connector G3/4" (26.5mm) LB (min 30)					Art.no. 1027058	EAN 
Height: 4,0cm	Length: 3,5cm	Width: 3,5cm	Weight: 0,01kg	Retailbox: 30	Oldart.no. -	



x30



3/4"



Universal fit. Fits with other brands.

- Tap connector provides water-tight seal from water source to hose.
- Fits Ø 265 mm (G 3/4") faucets.
- Easy-to-twist design.
- Comes in loose box of 30 pc without product card, but with EAN sticker.
- Universal fit – Fits with other brands.

Please note! The black retail box must be ordered separately, shipped as a set of 4 pcs (flatpacked), Product code: 1027677, EAN code: 6411501511386.

Tap Connector G1" (33.3mm) LB (min 30)					Art.no. 1027059	EAN 
Height: 4,0cm	Length: 4,2cm	Width: 4,2cm	Weight: 0,01kg	Retailbox: 30	Oldart.no. -	



x30



1"



Universal fit. Fits with other brands.

- Tap connector provides water-tight seal from water source to hose.
- Fits Ø 333 mm (G 1") faucets.
- Easy-to-twist design.
- Comes in loose box of 30 pc without product card, but with EAN sticker.
- Universal fit – Fits with other brands.

Please note! The black retail box must be ordered separately, shipped as a set of 4 pcs (flatpacked), Product code: 1027677, EAN code: 6411501511386.

Extension Connector LB (min 30)					Art.no. 1027069	EAN 
Height: 5,2cm	Length: 3,2cm	Width: 3,2cm	Weight: 0,02kg	Retailbox: 30	Oldart.no. -	



x30





Universal fit. Fits with other brands.

- Comes in loose box of 1027068 Extension connector 30 pc without product card, but with EAN sticker.
- Universal fit – Fits with other brands.

Please note! The black retail box must be ordered separately, shipped as a set of 4 pcs (flatpacked), Product code: 1027677, EAN code: 6411501511386.

Accessories

Complement your watering set with our easy-to-use accessories for added convenience in storing and spraying.

Timer, dual outlet					Art.no. 1054792	EAN 6 411501 511782
Height: 22,2cm	Length: 8,3cm	Width: 15,0cm	Weight: 0,58kg	Retailbox: 4	Oldart.no. -	

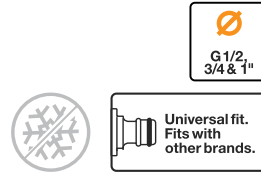

- Program the timer to run two hoses independently or simultaneously.
- Watering duration from 1 - 360 minutes.
- Rain delay up to 7 days.
- Easy-to-program watering start and stop times, frequency and duration.
- Tap connector includes three threads to fit most common faucet sizes.
- Operates with 2xAA batteries (not included), stops watering in case of low battery - low-battery safeguard.

Timer, single outlet					Art.no. 1054791	EAN 6 411501 511775
Height: 20,0cm	Length: 8,3cm	Width: 15,0cm	Weight: 0,38kg	Retailbox: 4	Oldart.no. -	

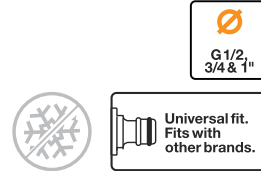

- Easy-to-program watering start and stop times, frequency and duration.
- Watering duration from 1 - 360 minutes.
- Rain delay up to 7 days.
- Multi tap connector includes three threads to fit most common faucet sizes.
- Stops watering in case of low battery - low-battery safeguard.
- Operates with 2xAA batteries (not included).
- Universal fit - Fits with other brands.

Pressure Sprayer, 5 L					Art.no. 1025934	EAN 6 411501 510624
Height: 49,5cm	Length: 18,5cm	Width: 18,5cm	Weight: 1,30kg	Retailbox: 4	Oldart.no. -	



- Light pressure sprayer is ideal for water-based plant treatments and gentle watering of new seedlings.
- Adjustable spray pattern from jet to soft mist.
- Shoulder strap for convenient carrying.
- 5 L net capacity (58 L maximum capacity).
- Not suited for spray solvents, aggressive chemicals, petroleum by-products or food products.

Pressure Sprayer, 1.8 L					Art.no. 1027379	EAN 6 411501 511379
Height: 31,0cm	Length: 12,5cm	Width: 22,0cm	Weight: 0,30kg	Retailbox: 9	Oldart.no. -	



- Light pressure sprayer is ideal for water-based plant treatments and gentle watering of new seedlings.
- Adjustable spray pattern from jet to soft mist.
- Easy-to-use features include thumb control with lock, safety valve for pressure stability, and graduated scale on container.
- 18 L net capacity (2 L maximum capacity).
- Not suited for spray solvents, aggressive chemicals, petroleum by-products or food products.

Wallmount for Waterwheel XL					Art.no. 1027095	EAN 6 411501 511201
Height: 27,5cm	Length: 13,0cm	Width: 19,5cm	Weight: 1,45kg	Retailbox: 4	Oldart.no. -	



- Optional wall mount for the Waterwheel XL (1025932).
- Durable FiberComp™ body and metal construction.
- Includes wall-mounting fasteners and easy-to-follow instructions.

Wallmount for Waterwheel S					Art.no. 1020448	EAN 6 411501 510129
Height: 25,0cm	Length: 9,5cm	Width: 3,0cm	Weight: 0,60kg	Retailbox: 4	Oldart.no. -	



- Optional wall mount for the Waterwheel S (1020436).
- Durable metal construction.
- Includes wall-mounting fasteners and easy-to-follow instructions.

Wallmount for Solid Waterwheel					Art.no. 1059235	EAN 6 411501 511980
Height: 53,4cm	Length: 5,0cm	Width: 7,3cm	Weight: 0,34kg	Retailbox: 3	Oldart.no. -	



- Optional wall mount for Solid Waterwheel M (1057238) and L (1057237).
- Durable construction.
- Includes wall-mounting fasteners and easy-to-follow instructions.

Sprinkler Adapter					Art.no. 1027089	EAN 6 411501 511140
Height: 11,4cm	Length: 3,8cm	Width: 7,4cm	Weight: 0,02kg	Retailbox: 6	Oldart.no. -	



- Replacement part for all Fiskars sprinklers.
- Universal fit - Fits with other brands.

O-rings for sprinklers, 4 pcs					Art.no. 1024091	EAN 6 411501 510471
Height: 11,4cm	Length: 1,6cm	Width: 7,4cm	Weight: 0,01kg	Retailbox: 6	Oldart.no. -	



- Includes 4 O-rings.
- Replacement part for all Fiskars sprinklers.

O-rings for connectors, 4 pcs					Art.no. 1024093	EAN 6 411501 510495
Height: 11,6cm	Length: 1,6cm	Width: 7,4cm	Weight: 0,01kg	Retailbox: 6	Oldart.no. -	



- Includes 4 O-rings.
- Replacement part for all Fiskars sprinklers, nozzles, wands and extension connectors.

Filter for sprinklers, 2 pcs					Art.no. 1024092	EAN 6 411501 510488
Height: 11,5cm	Length: 1,6cm	Width: 7,4cm	Weight: 0,02kg	Retailbox: 6	Oldart.no. -	



- Includes 2 filters.
- Replacement part for all Fiskars sprinklers.

Oscillating Sprinkler maintenance kit					Art.no. 1072123	EAN 6 411501 512970
Height: 14,0cm	Length: 2,4cm	Width: 10,8cm	Weight: 0,01kg	Retailbox: 4	Oldart.no. -	



- Includes a nozzle cleaning tool and a tube filter.
- For use with the following Fiskars oscillating sprinklers: X-Series L (1070831) X-Series M (1070832), Comfort L (1070833), Comfort M (1070834).
- Nozzle cleaning tool removes dirt, scale and debris from clogged nozzles, stores in end cap of sprinkler tube.
- Rust-resistant filter prevents dirt from entering sprinkler tube from hose.



Car Tools

Car & Camping Tools

SnowXpert™ Car Shovel					Art.no. 1019347	EAN 6 411501 430724
Height: 63cm	Length: 10,5cm	Width: 22cm	Weight: 0,52kg	Retail box: 6	Oldart.no. 143072	



- Stainless steel blade for increased durability.
- Durable composite structure.
- Lightweight and handy size.

SnowXpert™ Brush & Ice Scraper					Art.no. 1019352	EAN 6 411501 430625
Height: 67cm	Length: 9,2cm	Width: 9,5cm	Weight: 0,22kg	Retail box: 6	Oldart.no. 143062	



- 2-sided non scratching elastic bristles.
- Double bladed scraper.
- Easy to store detachable structure.

Foldable Spade					Art.no. 1000621	EAN 6 411503 275019
Height: 24,5cm	Length: 6,5cm	Width: 16,5cm	Weight: 1,04kg	Retail box: 4	Oldart.no. 131320	



- Easily foldable spade and hoe, ideal for camping, sports, etc.
- Canvas sheath for safe storage and protection.
- Hardened boron steel, aluminium and plastic spade.
- Unfolded the spade is 590 mm in length.

Snow Light Car Shovel					Art.no. 1000740	EAN 7 317794 310004
Height: 71cm	Length: 12cm	Width: 25cm	Weight: 0,63kg	Retail box: 3	Oldart.no. 141020	



- Aluminium shaft with ergonomic plastic coating.
- Ergonomically designed handle.
- Hardened aluminium blade.

Safety Camping & Car Spade					Art.no. 1001574	EAN 6 411503 270007
Height: 70cm	Length: 13cm	Width: 20,4cm	Weight: 0,48kg	Retail box: 6	Oldart.no. 131520	



- Lightweight spade which floats in water for camping and gardening.
- Plastic (PP) handle resists low temperatures.
- Durable aluminium scoop for rigidity and high tensile strength.
- Hexagonal shaft for extra grip.

Solid™ Car Shovel					Art.no. 1019353	EAN 6 411501 430731
Height: 63cm	Length: 10,5cm	Width: 22cm	Weight: 0,50kg	Retail box: 6	Oldart.no. 143073	



- Functional tool for removing snow around the car.
- Compact enough to fit inside any car.
- Durable structure.

Solid™ Ice Scraper					Art.no. 1019354	EAN 6 411501 430632
Height: 21,5cm	Length: 5,8cm	Width: 9,5cm	Weight: 0,07kg	Retail box: 8	Oldart.no. 143063	



- Functional tool for removing ice from the car windows.
- Sturdy and durable structure.

Snow Tools



X-series™ Telescopic & Curved Snow Tools

Features & benefits

Durable

- 1 Reinforced blade edge lasts 3x longer and cuts easily into hard-packed snow
- 2 Durable, long wearing materials that withstand temperatures up to -30°C. Made in Finland.

Light

- 3 Light-weight aluminium shafts & polymer scoops
- 4 Adjustable handle lengths for less back strain

Easy-to-use

- 5 Advanced new scoop design made with a low-friction material that allows snow to glide off
- 6 Textured, non-slip grips for better control and insulation against cold.
- 6 Large handles sized for use with winter gloves. Keeps wrist in comfortable position



X-series™ Snow Tools

Exceptional performance.

Our top-of-the-line range of snow tool products combines the best of our technologies and ergonomics with the ultimate in durability, offering a best-in-class option that truly improves the perception - and experience - of the activity itself.

X-series™ Snow shovel

Height: 132 cm	Length: 19,5 cm	Width: 36,2 cm	Weight: 1,40 kg	Retail box: 3
----------------	-----------------	----------------	-----------------	---------------

Art.no. 1057177



- Deep scoop for easy shovelling of large amounts of snow.
- Reinforced blade edge lasts 3x longer.
- Lightweight tool with an aluminium shaft.
- Large handle, sized for use with winter gloves.
- Textured non-slip grip for better control and insulation against cold.
- Low-friction scoop helps snow glide off.
- Withstands up to -30°C.

X-series™ Snow pusher

Height: 153,5 cm	Length: 19 cm	Width: 53 cm	Weight: 1,58 kg	Retail box: 3
------------------	---------------	--------------	-----------------	---------------

Art.no. 1057178



- Wide head for easy pushing of large amounts of snow.
- Reinforced blade edge lasts 3x longer.
- Lightweight tool with an aluminium shaft.
- Large D-handle with non-slip SoftGrip™ is sized for use with winter gloves.
- Textured non-slip grip for better control and insulation against cold.
- Low-friction scoop helps snow glide off.
- Withstands up to -30°C.

X-series™ Snow roller

Height: 173 cm	Length: 11,5 cm	Width: 53 cm	Weight: 1,52 kg	Retail box: 3
----------------	-----------------	--------------	-----------------	---------------

Art.no. 1057179



- Scoop designed for clearing lighter layers of snow by pushing forward in a rolling wave.
- Reinforced blade edge lasts 3x longer.
- Lightweight tool with an aluminium shaft.
- Large handle, sized for use with winter gloves.
- Textured non-slip grip for better control and insulation against cold.
- Low-friction scoop helps snow glide off.
- Withstands up to -30°C.

X-series™ Car snow shovel

Height: 98,5 cm	Length: 10 cm	Width: 29 cm	Weight: 1 kg	Retail box: 4
-----------------	---------------	--------------	--------------	---------------

Art.no. 1057393



- For efficient clearing of snow around the car.
- Deep scoop moves large quantities of snow fast & efficiently.
- Reinforced blade edge lasts 3x longer.
- Compact size for easy storage.
- Lightweight tool with an aluminium shaft.
- Large handle, sized for use with winter gloves.
- Withstands up to -30°C.

X-series™ Snow Pusher, Curved					Art.no. 1057186	EAN 6 411501 410351
Height: 153cm	Length: 11,5cm	Width: 53,2cm	Weight: 1,57kg	Retailbox: 3	Oldart.no. -	



- Wide head for easy pushing of large amounts of snow.
- Reinforced blade edge lasts 3x longer.
- Curved shaft helps the user keep the back straight.
- Lightweight tool with an aluminium shaft.
- Large D-handle with non-slip SoftGrip™ is sized for use with winter gloves.
- Textured non-slip grip for better control and insulation against cold.
- Withstands up to -30°C.

X-series™ Car Snow Shovel, Telescopic					Art.no. 1057187	EAN 6 411501 410368
Height: 79,5cm	Length: 15,4cm	Width: 29cm	Weight: 1,14kg	Retailbox: 4	Oldart.no. -	



- For efficient clearing of snow around the car.
- Deep scoop moves large quantities of snow fast & efficiently.
- Reinforced blade edge lasts 3x longer.
- Telescopic handle adjustable to a compact size for easy storage.
- Lightweight tool with an aluminium shaft.
- Large handle, sized for use with winter gloves.
- Withstands up to -30°C.

X-series™ Snow Shovel, Telescopic					Art.no. 1057188	EAN 6 411501 410375
Height: 120cm	Length: 19,4cm	Width: 36,2cm	Weight: 1,59kg	Retailbox: 3	Oldart.no. -	



- Deep scoop for easy shovelling of large amounts of snow.
- Reinforced blade edge lasts 3x longer.
- Adjustable telescopic handle guarantees optimal user ergonomics.
- Lightweight tool with an aluminium shaft.
- Large handle, sized for use with winter gloves.
- Textured non-slip grip for better control and insulation against cold.
- Withstands up to -30°C.

X-series™ Snow Pusher, Telescopic					Art.no. 1057189	EAN 6 411501 410382
Height: 143,4cm	Length: 9cm	Width: 53,2cm	Weight: 1,79kg	Retailbox: 3	Oldart.no. -	



- The reinforced blade with a stainless steel core makes the tool up to 3x more durable.
- Telescopic shaft with adjustment between 143-163 cm.
- Lightweight tool with an aluminium shaft.
- Non-slip grip on both handle and shaft.
- Resistant up to -30°C.

Other Snow Tools

SnowXpert™ Sledge					Art.no. 1003470	EAN 6 411501 430212
Height: 149cm	Length: 27,5cm	Width: 75cm	Weight: 4,30kg	Retailbox: 1	Oldart.no. 143021	



- Lightweight snow sledge for larger snow clearance, e.g. yard and parking area.
- Long, sturdy, tubular steel handle for easy use.
- Injection moulded scoop for high stability and lightness.
- Orange reflector for visibility in the dark.

Professional Snow Sledge					Art.no. 1001631	EAN 6 411503 237956
Height: 149cm	Length: 33cm	Width: 83cm	Weight: 7,20kg	Retailbox: 6	Oldart.no. 143040	



- Tubular steel handle.
- Tough zinc-coated steel edge.
- Safety reflectors on handles.
- Orange reflector for visibility in the dark.

Ice Iron					Art.no. 1001639	EAN 6 411503 239905
Height: 147,5cm	Length: 4cm	Width: 17,5cm	Weight: 1,40kg	Retailbox: 4	Oldart.no. 140000	



- Designed for breaking, chipping and clearing ice.
- Solid, painted blade made of hardened boron steel.
- Wooden shaft.
- FSC® certified wood.

Snow and Grain Shovel					Art.no. 1001637	EAN 6 411503 235280
Height: 127cm	Length: 20cm	Width: 31cm	Weight: 1,40kg	Retailbox: 4	Oldart.no. 142000	



- Birchwood shaft.
- Polypropylene grip.
- High-quality aluminium blade.
- FSC® certified wood.

Snow Light Snow Pusher - Aluminium					Art.no. 1001636	EAN 5 905568 800435
Height: 162,2cm	Length: 12,5cm	Width: 53,2cm	Weight: 1,60kg	Retailbox: 4	Oldart.no. 143060	



- Aluminium shaft with plastic coating.
- Ergonomically designed handle.
- Hardened aluminium blade.

Accessories



Accessories

Axe and Tool Gloves Size 8					Art.no. 1071129	EAN 6 411501 600424
Height: 33 cm	Length: 2,5 cm	Width: 10,5 cm	Weight: 0,07 kg	Retail box: 10	Oldart.no. -	



- Fiskars® Tool and Wood Gloves provide comfort and protection from injuries that can occur, especially when working with axes and using garden tools or hand actuating tools.
- Ideal for handling axes, garden power tools and hand actuated cutters while performing wood preparation, general maintenance and repair, and home improvement projects.
- Gloves are made of artificial leather with backhand mesh for breathability and all-day comfort.
- Additional reinforcement between thumb and index finger, and palm area for enhanced durability.

Axe and Tool Gloves Size 10					Art.no. 1071150	EAN 6 411501 600431
Height: 34 cm	Length: 2,5 cm	Width: 11,5 cm	Weight: 0,08 kg	Retail box: 10	Oldart.no. -	



- Fiskars® Tool and Wood Gloves provide comfort and protection from injuries that can occur, especially when working with axes and using garden tools or hand actuating tools.
- Ideal for handling axes, garden power tools and hand actuated cutters while performing wood preparation, general maintenance and repair, and home improvement projects.
- Gloves are made of artificial leather with backhand mesh for breathability and all-day comfort.
- Additional reinforcement between thumb and index finger, and palm area for enhanced durability.

Axe and Tool Gloves Size 12					Art.no. 1071151	EAN 6 411501 600448
Height: 36 cm	Length: 2,5 cm	Width: 12,5 cm	Weight: 0,09 kg	Retail box: 10	Oldart.no. -	



- Fiskars® Tool and Wood Gloves provide comfort and protection from injuries that can occur, especially when working with axes and using garden tools or hand actuating tools.
- Ideal for handling axes, garden power tools and hand actuated cutters while performing wood preparation, general maintenance and repair, and home improvement projects.
- Gloves are made of artificial leather with backhand mesh for breathability and all-day comfort.
- Additional reinforcement between thumb and index finger, and palm area for enhanced durability.

Shrub Care Gloves Size 8					Art.no. 1071152	EAN 6 411501 600455
Height: 39 cm	Length: 2,5 cm	Width: 10,5 cm	Weight: 0,08 kg	Retail box: 10	Oldart.no. -	



- Fiskars® Shrub Care gloves provide the needed hand and wrist coverage to prevent injury or damage, especially while working with holly or berry bushes.
- Ideal for handling garden tools and hand actuated cutters while working with prickly shrubs.
- Gloves are made of artificial leather with added reinforcement between thumb and index finger, and palm area for enhanced durability.

Shrub Care Gloves Size 10					Art.no. 1071153	EAN 6 411501 600462
Height: 39,5 cm	Length: 2,5 cm	Width: 11,5 cm	Weight: 0,10 kg	Retail box: 10	Oldart.no. -	



- Fiskars® Shrub Care gloves provide the needed hand and wrist coverage to prevent injury or damage, especially while working with holly or berry bushes.
- Ideal for handling garden tools and hand actuated cutters while working with prickly shrubs.
- Gloves are made of artificial leather with added reinforcement between thumb and index finger, and palm area for enhanced durability.

Garden Work Gloves Size 10

Height: 25 cm	Length: 1,5 cm	Width: 12 cm	Weight: 0,07 kg	Retail box: 10
----------------------	-----------------------	---------------------	------------------------	-----------------------

Art.no. **1003477**Oldart.no. **160004**

EAN



- Non-slip grip with axes and stick tools.
- Reinforced for rough manual work.

Garden Work Gloves Size 8

Height: 24 cm	Length: 1,5 cm	Width: 11,5 cm	Weight: 0,06 kg	Retail box: 10
----------------------	-----------------------	-----------------------	------------------------	-----------------------

Art.no. **1003478**Oldart.no. **160005**

EAN



- Non-slip grip with axes and stick tools.
- Reinforced for rough manual work.

Winter Gloves

Height: 25 cm	Length: 2 cm	Width: 12 cm	Weight: 0,08 kg	Retail box: -
----------------------	---------------------	---------------------	------------------------	----------------------

Art.no. **1015447**Oldart.no. **160007**

EAN



- Non-slip grip with axes and stick tools.
- Reinforced for rough manual work.
- Soft shell polyuretane resists moisture and ensures a good grip.



Fiskars Pro Hardware Tools



Hardware saws [p.234](#)

CarbonMax™ knives [p.240](#)

Hardware knives [p.248](#)

PowerGear™ Aviation Snips [p.252](#)

PowerArc™ Scissors [p.256](#)

PowerGear™ Bolt Cutters [p.260](#)

IsoCore™ Tools [p.262](#)

Striking Tools [p.263](#)

Hammers [p.267](#)

Demolition Tools [p.269](#)

Iron bars [p.270](#)



Fiskars Pro Tools



Content

231 Hardware Tools

234 Hardware Saws

- 236 Handsaws
- 237 Other saws
- 238 Replacement blades

240 CarbonMax™ Knives

Introducing blades that stay sharp 24x longer than the competition

- 243 Utility Knives
- 244 Snap-off utility knives
- 245 Replacement blades

248 Hardware Knives

252 PowerGear™ Aviation Snips

Make tough jobs dramatically easier with leverage-enhancing tools.

256 PowerArc™ Scissors

Make cutting easier, especially at the end of the cut where more force is required

- 258 Amplify™ Scissors
- 259 Classic Hardware Scissors

260 PowerGear™ Bolt Cutters

Make cutting hardened rods up to 30 % easier, especially in the beginning of the cut where more force is required

262 IsoCore™ Tools

Shock control system absorbs strike shock and vibration to reduce the punishment your body takes, transferring up to 70 % less shock and vibration than wood handles

263 Striking Tools

267 Hammers

269 Demolition Tools

270 Iron bars

Please note! All the measurements portrayed in the catalogue are products in packaging measurements.

POS materials

The Fiskars® Pro assortment is supported by a wide range of POS materials, from category-specific top signs and posters, to popups and wobblers, to informative shelf-dividers with detailed information about technologies and products.

We also offer a modular display which is easily stacked with our shelf-ready retail packaging.



Pop-ups (600 x 1600 mm)



Shelf-dividers (200 x 1000 mm)

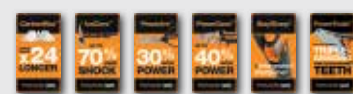

Wobblers (110 x 200 mm)



Wobblers (110 x 110 mm)



Universal displays (790 x 298 mm)



Floor stickers (650 mm)



Retail boxes

Utility knives, claw hammers, aviation snips & heavy duty scissors come in shelf-ready retail packaging.

PowerTooth™ Universal hand saws



Fine teeth for a controlled easy cut start.

PowerTooth™ technology offering precise triple-grinding for razor-sharp teeth.

PowerTooth™

INDUCTION-HARDENED

TRIPLE-GRINDING FOR RAZOR-SHARP TEETH

Included sheath securely locks onto blade for safe storage and transport and includes a built-in carpenter pencil holder.



Intelligently textured SoftGrip™ that displaces moisture, prevents blisters and provides a slip-free hold.

Power support to rip through rough materials.

Sharper.
Razor-sharp PowerTooth™ blade cuts faster & stays sharp longer.

Tougher.
Full-body metal construction, tested to withstand drops and impacts.

More Comfortable.
Ergonomic design supports multiple grips for whatever the job demands.

Saws

Hacksaw

Blade tensioning mechanism that clicks into place for optimal tensioning every time. A secondary grip feature for two-handed power, precision and control. Blade secures in out-front position for cutting in small spaces.



TrueTension™
BLADE TENSIONING
"CLICKS" INTO PLACE

Soft Grip™
On-tool blade storage

Soft Grip™
Lock

Folding pull saws

Folding mechanism to protect fine delicate teeth and protect user from abrasions with a quick, accessible lock that clicks to communicate a securely locked blade. Hex bolt for intuitive and secure blade replacement.



PowerTooth™
INDUCTION-HARDENED
TRIPLE-GRINDING FOR RAZOR-SHARP TEETH

PowerTooth™
INDUCTION-HARDENED
TRIPLE-GRINDING FOR RAZOR-SHARP TEETH

Soft Grip™
Lock

Soft Grip™
Flexible blade
Non-Stick

Compact folding saw

Accepts standard reciprocating saw blades and opens with the flick of the wrist. Intuitive, fast front-loading blade change that fits standard reciprocating saw blades. Ergonomic control positioning for comfort in tight situations.



PowerTooth™
INDUCTION-HARDENED
TRIPLE-GRINDING FOR RAZOR-SHARP TEETH

PowerTooth™
INDUCTION-HARDENED
TRIPLE-GRINDING FOR RAZOR-SHARP TEETH

Soft Grip™
Universal fit. Fits 15 cm reciprocating saw blades

Soft Grip™
Lock
Non-Stick

Jab saw with sheath

Ultra-sharp, sturdy fixed blade with rugged sheath for ultimate safety. PowerTooth™ technology offering precise triple-grinding for razor-sharp teeth and a rasp for smoothing out rough cuts. The reinforced metal pommel end provides reliable resistance against pounding and drops.

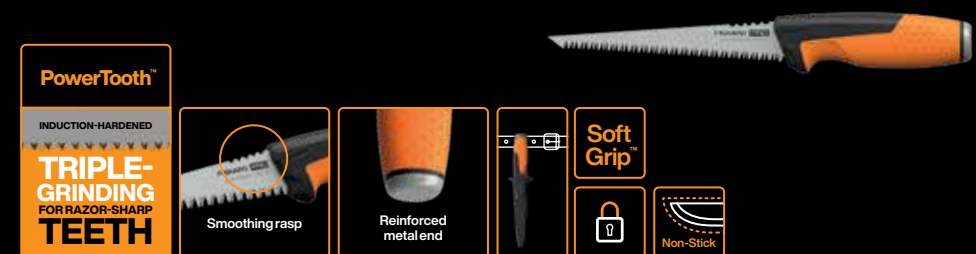

PowerTooth™
INDUCTION-HARDENED
TRIPLE-GRINDING FOR RAZOR-SHARP TEETH

PowerTooth™
INDUCTION-HARDENED
TRIPLE-GRINDING FOR RAZOR-SHARP TEETH

Soft Grip™
Reinforced metal end

Soft Grip™
Lock
Non-Stick

Hardware Saws | Handsaws

PowerTooth™ Handsaw, 380mm 9tpi					Art.no. 1062930	EAN 6 411501 201133
Height: 49,85cm	Length: 4,06cm	Width: 17,78cm	Weight: 0,51kg	Retailbox: 3	Oldart.no. -	



- Triple-ground saw blade for fast, powerful cuts.
- RapidStart™ blade technology offers greater control with virtually no binding for quicker, cleaner cut starts.
- Middle and heel of blade feature 9 TPI for forceful, smooth cuts through all types of wood, laminate, PVC and more.
- Oversized handle fits gloved hands, and innovative texturing on SoftGrip™ handle provides a slip-free hold.
- Includes blade protector with built-in pencil holder.

PowerTooth™ Handsaw, 500mm 9tpi					Art.no. 1062919	EAN 6 411501 201126
Height: 62,55cm	Length: 4,06cm	Width: 17,78cm	Weight: 0,57kg	Retailbox: 3	Oldart.no. -	



- Triple-ground saw blade for fast, powerful cuts.
- RapidStart™ blade technology offers greater control with virtually no binding for quicker, cleaner cut starts.
- Middle and heel of blade feature 9 TPI for forceful, smooth cuts through all types of wood, laminate, PVC and more.
- Oversized handle fits gloved hands, and innovative texturing on SoftGrip™ handle provides a slip-free hold.
- Includes blade protector with built-in pencil holder.

PowerTooth™ Handsaw, 550mm 7tpi					Art.no. 1062916	EAN 6 411501 201096
Height: 67,31cm	Length: 4,06cm	Width: 17,78cm	Weight: 0,58kg	Retailbox: 3	Oldart.no. -	



- Triple-ground saw blade for fast, powerful cuts.
- RapidStart™ blade technology offers greater control with virtually no binding for quicker, cleaner cut starts.
- Middle and heel of blade features 7 TPI for forceful cuts through all types of wood, laminate, PVC and more.
- Oversized handle fits gloved hands, and innovative texturing on SoftGrip™ handle provides a slip-free hold.
- Includes blade protector with built-in pencil holder.

PowerTooth™ Handsaw, 550mm 9tpi					Art.no. 1062917	EAN 6 411501 201102
Height: 67,31cm	Length: 4,06cm	Width: 17,78cm	Weight: 0,58kg	Retailbox: 3	Oldart.no. -	



- Triple-ground saw blade for fast, powerful cuts.
- RapidStart™ blade technology offers greater control with virtually no binding for quicker, cleaner cut starts.
- Middle and heel of blade feature 9 TPI for forceful, smooth cuts through all types of wood, laminate, PVC and more.
- Oversized handle fits gloved hands, and innovative texturing on SoftGrip™ handle provides a slip-free hold.
- Includes blade protector with built-in pencil holder.

PowerTooth™ Handsaw, 550mm 11tpi					Art.no. 1062918	EAN 6 411501 201119
Height: 67,31cm	Length: 4,06cm	Width: 17,78cm	Weight: 0,58kg	Retailbox: 3	Oldart.no. -	

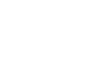

- Triple-ground saw blade for fast, powerful cuts.
- RapidStart™ blade technology offers greater control with virtually no binding for quicker, cleaner cut starts.
- Middle and heel of blade feature 11 TPI for smooth, clean cuts through softer wood.
- Oversized handle fits gloved hands, and innovative texturing on SoftGrip™ handle provides a slip-free hold.
- Includes blade protector with built-in pencil holder.

Other Saws

TrueTension™ Hacksaw, 300mm 24tpi					Art.no. 1062931	EAN 6 411501 201140
Height: 41,27cm	Length: 1,52cm	Width: 18,42cm	Weight: 0,83kg	Retailbox: 3	Oldart.no. -	



- Intuitive tensioning mechanism 'clicks' when optimal tensioning is achieved.
- TrueTension™ provides confidence in tensioning for frustration-free blade tightening.
- Quick, clean cuts on metal, plastic, PVC, conduit, copper pipe, bolts, nails and more.
- Blade changes are faster and easier with no loose parts and visible, easily accessible on-tool blade storage.
- Innovative texturing on SoftGrip™ handle provides a slip-free hold.
- Includes one long-lasting, bimetal blade (24 TPI). Replacement blades available (item #1062941).

PowerTooth™ Detail Pull saw, 150mm 19tpi					Art.no. 1062932	EAN 6 411501 201157
Height: 40,96cm	Length: 2,79cm	Width: 12,7cm	Weight: 0,20kg	Retailbox: 6	Oldart.no. -	



- Secure folding and locking mechanism protects exposed teeth and prevents accidental deployment.
- Fine-finish, 19 TPI blade offers excellent accuracy and control for detailed, clean cuts.
- Flexible for quick, easy and clean flush cuts.
- Compact size allows for easy access and is ideal for precise cuts.
- Ideal for use on softer woods.
- SoftGrip™ touchpoints feature innovative texturing that displaces moisture, prevents blisters and provides a slip-free hold.
- Replacement blades available (item #1062942).

PowerTooth™ Folding Pull saw, 250mm 13tpi					Art.no. 1062933	EAN 6 411501 201164
Height: 60,96cm	Length: 2,79cm	Width: 15,24cm	Weight: 0,32kg	Retailbox: 3	Oldart.no. -	



- Secure folding and locking mechanism protects exposed teeth and prevents accidental deployment.
- Optimized 13 TPI blade offers excellent precision and control on softer woods, while allowing for general cuts on 2x4s, PVC and more.
- Flexible for easy, clean flush cuts.
- Hooked end provides a secure hold for pulling motion.
- SoftGrip™ touchpoints feature innovative texturing that displaces moisture, prevents blisters and provides a slip-free hold.
- Replacement blades available (item #1062943).

Compact Folding Toolbox Saw, 2 blades					Art.no. 1062934	EAN 6 411501 201171
Height: 33,65cm	Length: 2,79cm	Width: 12,7cm	Weight: 0,19kg	Retailbox: 6	Oldart.no. -	



- Easily stores in your toolbox.
- One-handed, flip-open design allows for fast blade deployment with just the flick of a wrist.
- Quick, easy, front-loading blade changes.
- Optimal for most 15 cm reciprocating saw blades.
- SoftGrip™ touchpoints feature innovative texturing that displaces moisture, prevents blisters and provides a slip-free hold.
- Includes two saw blades with induction-hardened teeth: One 13 TPI Power Tooth™ blade for wood and plastic and one 24 TPI bi-metal blade for metal.

PowerTooth™ Jab Saw with Sheath 8tpi					Art.no. 1062935	EAN 6 411501 201188
Height: 38,74cm	Length: 3,81cm	Width: 15,24cm	Weight: 0,18kg	Retailbox: 6	Oldart.no. -	



- Jab saw snaps into sheath for a secure fit. Sheath features a belt clip and hang hole for storage.
- Triple-ground blade cuts with speed and efficiency with ultra-sharp tip for piercing quick starts through plasterboards.
- Rasp on non-sawing side of blade smooths out rough cuts.
- Handle is sized and shaped for optimized comfort and control with textured SoftGrip™ for a slip-free hold.
- Reinforced metal end protects against pounding and drops.
- Low-friction blade coating resists rust and dust buildup.

Other Saws | Replacement blades

Builder's Saw, 233mm					Art.no. 1000612	EAN 6 411501 238603
Height: 3,4 cm	Length: 40 cm	Width: 8,5 cm	Weight: 0,13 kg	Retail box: 4	Oldart.no. -	



- Fine toothing for cutting dry wood.
- Cuts on the pull stroke.
- Blade can be safely stored inside the handle when not in use.
- Features a handy belt clip for easy carrying.
- SoftGrip™ handle ensures a safe grip during operations.
- Finger guard protects fingers from sliding to the blade part.

Replacement Blade Hacksaw 300mm 24tpi					Art.no. 1062941	EAN 6 411501 201249
Height: 0,64 cm	Length: 5,08 cm	Width: 36,83 cm	Weight: 0,05 kg	Retail box: 12	Oldart.no. -	

- Bi-metal constructed for long-lasting sharpness.
- Ideal for clean cuts through metal, plastic, PVC and more.
- Fits Fiskars® Pro TrueTension™ hacksaw (item #1062931) with on-tool blade storage.

Replacement Blade Pull Saw 150mm 19tpi					Art.no. 1062942	EAN 6 411501 201256
Height: 0,64 cm	Length: 12,7 cm	Width: 25,4 cm	Weight: 0,09 kg	Retail box: 12	Oldart.no. -	



- Bind-resistant profile with 19 TPI for fine finishing work.
- Ideal for accurate, controlled cuts on softer woods.
- Thin kerf allows flexibility for quick, clean flush cuts.
- Induction-hardened teeth provide long-lasting sharpness.
- Low-friction coating prolongs blade life and resists rust.
- Fits Fiskars® Pro folding detail pull saw (item #1062932), which has an intuitive hex-bolt blade replacement mechanism.

Replacement Blade Pull Saw 250mm 13tpi					Art.no. 1062943	EAN 6 411501 201263
Height: 0,64 cm	Length: 12,7 cm	Width: 35,56 cm	Weight: 0,14 kg	Retail box: 12	Oldart.no. -	



- Bind-resistant profile with 13 TPI for a fine finish.
- Ideal for controlled cuts on softer woods as well as general cuts on 2x4s, PVC and more.
- Thin kerf allows flexibility for quick, clean flush cuts.
- Induction-hardened teeth provide long-lasting sharpness.
- Low-friction coating prolongs blade life and resists rust.
- Fits Fiskars® Pro Folding pull saw (item #1062933), which has an intuitive hex-bolt blade replacement mechanism.

Cut faster, straighter, closer & safer.

Builder's Saw



CarbonMax™

Sharper.

CarbonMax™ blades stay sharp longer than the competition – even carbide.

Tougher.

Full-body metal construction, tested to withstand drops and impacts.

More comfortable.

Ergonomic design supports multiple grips for whatever the job demands.



Sharper,
smarter,
more durable
knives.

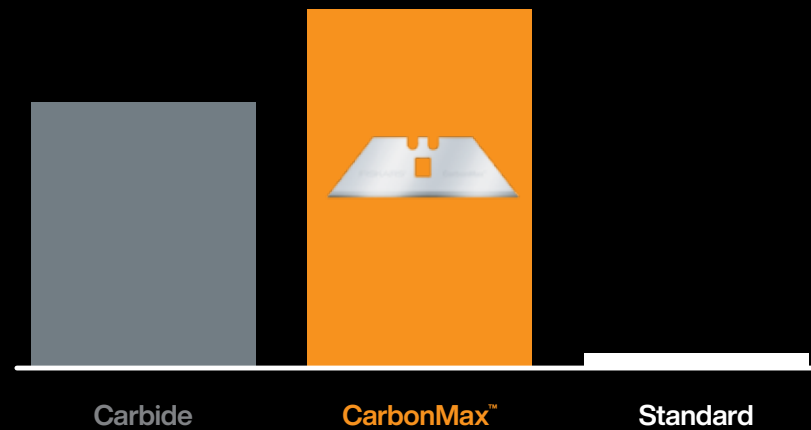

Laboratory tested and verified.

CarbonMax™



STAYS SHARP
x24
LONGER

Utility Knives

Visual and audible cues ensure the blade is locked into place

CarbonMax™ blades that stay sharp 24 times longer

Full metal body for optimal balance and ultimate, jobsite durability

Secure locking system prevents accidental release, without sacrificing blade change speed

Features dynamic grip pattern for all day comfort and control

Folding blade guard deploys with the push of a button

Internal blade storage for up to 5 blades

Superior ergonomics with contoured handle & SoftGrip™

Soft Grip™

Reinforced metal end resists impact from pounding & drops

CarbonMax™
STAYS SHARP
x24
LONGER

CarbonMax™ Knives

CarbonMax™ Compact Folding Utility Knife						Art.no. 1062939	EAN 6 411501 201225
Height: 18,42 cm	Length: 2,13 cm	Width: 10,8 cm	Weight: 0,84 kg	Retail box: 3	Old art.no. -		
					<ul style="list-style-type: none"> • Smaller than other folding utility knives for ultimate storage in pockets & toolbelts. • One-handed, flip-open design for fast blade deployment. • Quick, easy front-loading blade change. • Reinforced metal end for sturdy, reliable resistance against pounding and drops. 		
+1							
CarbonMax™ Safety Utility Knife						Art.no. 1062938	EAN 6 411501 201218
Height: 26,04 cm	Length: 2,95 cm	Width: 11,13 cm	Weight: 0,23 kg	Retail box: 3	Old art.no. -		
					<ul style="list-style-type: none"> • Auto-retracting blade for safety. • Intuitive, one-handed blade deployment. • Safety lock prevent accidental blade release. • Knife easily hinges open for tool-free blade changes. • Reinforced metal end for sturdy, reliable resistance against pounding and drops. 		
+1							
CarbonMax™ Fixed Utility Knife						Art.no. 1027222	EAN 6 411501 701404
Height: 25,9 cm	Length: 3 cm	Width: 10,9 cm	Weight: 0,20 kg	Retail box: 6	Old art.no. -		
					<p>Retail pack</p> <ul style="list-style-type: none"> • Folding blade guard deploys with the push of a button for convenient, easy protection. • Reinforced metal end provides reliable resistance against pounding and drops. • Knife hinges open for easy blade change with no loose parts. • Includes one CarbonMax™ utility blade. • Accommodates five standard-sized utility blades. 		
+1							
CarbonMax™ Retractable Utility Knife						Art.no. 1027223	EAN 6 411501 701411
Height: 25,9 cm	Length: 3 cm	Width: 10,9 cm	Weight: 0,17 kg	Retail box: 6	Old art.no. -		
					<p>Retail pack</p> <ul style="list-style-type: none"> • Side blade actuation helps prevent accidental blade retraction when you're in the middle of a job. • Knife easily hinges open with no loose parts to keep track of during blade change. • Reinforced metal end provides sturdy, reliable resistance against pounding and drops. • Includes one CarbonMax™ utility blade. • Accommodates five standard-sized utility blades. 		
+1							
CarbonMax™ Folding Utility Knife						Art.no. 1027224	EAN 6 411501 701428
Height: 18,5 cm	Length: 3 cm	Width: 10,9 cm	Weight: 0,17 kg	Retail box: 6	Old art.no. -		
					<p>Retail pack</p> <ul style="list-style-type: none"> • Dual-locking system prevents accidental blade release without sacrificing blade-change speed. • Easy, one-handed, flip-open design means knife opens with the flick of a wrist. • Ergonomic design, including deep grooves and contouring allows for multiple grips. • Reinforced metal end provides sturdy, reliable resistance against pounding and drops. 		
+1							

CarbonMax™ Painters Utility Knife					Art.no. 1027225	EAN 6 411501 701435
Height: 26cm	Length: 3,3cm	Width: 10,9cm	Weight: 0,24kg	Retailbox: 6	Oldart.no. -	



+1 

Retail pack

VPA GS
Sicherheit
Sicherheit

- Paint bucket opener allows you to easily open stubborn 18 L paint bucket lids.
- Includes #1 size flathead screwdriver bit, perfect for outlet covers and opening paint cans.
- Reinforced metal end provides sturdy, reliable resistance against drops and pounding.
- Knife easily flips open for one-handed deployment.
- Push & slide blade change with magnet for blade security.
- Accommodates two standard-sized utility blades.

CarbonMax™ Drywaller Utility Knife					Art.no. 1027226	EAN 6 411501 701442
Height: 26cm	Length: 3cm	Width: 10,9cm	Weight: 0,21kg	Retailbox: 6	Oldart.no. -	



+1 

Retail pack

VPA GS
Sicherheit
Sicherheit

- 2-in-1 tool with a standard blade + jab saw that punches through drywall for electrical boxes & more.
- Reinforced metal end to knock out drywall pieces, and to finish sinking screws and nails.
- Both blades deploy from the same end for ease and safety.
- Push & slide blade change includes magnet that secures blade.
- Top retraction button avoids accidental retraction.
- Knife hinges open for easy access and cleaning.
- Accommodates two standard-sized utility blades

Snap-off Knives | Changeable Blades



CarbonMax™ blades that stay sharp 24 times longer

Integrated segment snapper that easily snaps and captures used blades

STAYS SHARP x24 LONGER

Superior ergonomics with contoured handle & SoftGrip™

Soft Grip™

Secure locking system prevents accidental release, without sacrificing blade change speed

CarbonMax™ Snap-off Knife, 18mm					Art.no. 1027227	EAN 6 411501 701459
Height: 25,9cm	Length: 2,6cm	Width: 10,9cm	Weight: 0,15kg	Retailbox: 8	Oldart.no. -	



+1 

Retail pack

VPA GS
Sicherheit
Sicherheit

- Offers convenient, front-loading blade change with no loose parts.
- Integrated segment snapper safely snaps — and automatically captures — used blades.
- Reinforced metal end provides sturdy, reliable resistance against pounding and drops.
- Accommodates 18 mm snap-off utility blades.

CarbonMax™ Snap-off Knife, 25mm					Art.no. 1027228	EAN 6 411501 701466
Height: 25,9cm	Length: 2,9cm	Width: 10,9cm	Weight: 0,24kg	Retailbox: 6	Oldart.no. -	



+1 

Retail pack

VPA GS
Sicherheit
Sicherheit

- Offers convenient, front-loading blade change with no loose parts.
- Integrated segment snapper safely snaps — and automatically captures — used blades.
- Reinforced metal end provides sturdy, reliable resistance against pounding and drops.
- Accommodates 25 mm snap-off utility blades.

CarbonMax™ Utility Knife Blades, 5 pack					Art.no. 1027229	EAN 6 411501 701473
Height: 16,5cm	Length: 1cm	Width: 7,6cm	Weight: 0,02kg	Retailbox: 6	Oldart.no. -	



x 5

- Replacement blades for any CarbonMax™ utility knives.
- Blade features Fiskars' proprietary, edge-retention coating.
- Stays sharp up to 24x longer than standard utility blades.
- Laboratory tested and verified.
- Blades fit non-Fiskars knives as well.
- Pack includes 5 blades.

CarbonMax™ Snap-off Blades, 18mm, 5 pack					Art.no. 1027232	EAN 6 411501 701503
Height: 17,8cm	Length: 0,5cm	Width: 4,8cm	Weight: 0,02kg	Retailbox: 6	Oldart.no. -	



x 5

- Replacement blades for CarbonMax™ 18 mm snap-off utility knives.
- Blade features Fiskars' proprietary, edge-retention coating.
- Stays sharp up to 24x longer than standard utility blades.
- Laboratory tested and verified.
- Blade snaps off cleanly for a new sharp tip.
- Pack includes 5 x 18 mm blades.

CarbonMax™ Snap-off Blades, 25mm, 5 pack					Art.no. 1027233	EAN 6 411501 701510
Height: 21,6cm	Length: 1,6cm	Width: 7,6cm	Weight: 0,09kg	Retailbox: 6	Oldart.no. -	



x 5

- Replacement blades for CarbonMax™ 25 mm snap-off utility knives.
- Blade features Fiskars' proprietary, edge-retention coating.
- Stays sharp up to 24x longer than standard utility blades.
- Laboratory tested and verified.
- Blade snaps off cleanly for a new sharp tip.
- Pack includes 5 x 25 mm blades.



Stay Sharp™
knives for
every task

Hardware Knives

For effective cuts, it's important to keep your knife as sharp as possible. That's why we've integrated a high-quality sharpener into every sheath. This sheath is available for all knives within this range so you'll always have it with you.

The handle has great ergonomics, while innovation in the sheath allows for both left- and right-handed use. The range consists of 5 different colour-coded knives for all your building tasks.



Impact hammer head for deeper cuts

Soft Grip™ Superior ergonomics
Optimised handle shape with patent pending grip pattern that provides additional grip exactly where it is needed

Easy to use
Fully exposed handle makes it easy to extract the knife from its sheath

StaySharp™
+ Integrated sharpener

Reversible collar for left and right handed use

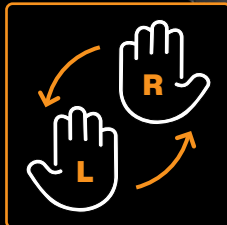

Hardware Knives | Fixed Blades

Builder's Knife with Sharpener (black)					Art.no. 1023617	EAN 6 411501 560162
Height: 22,7 cm	Length: 3,6 cm	Width: 4,2 cm	Weight: 0,09 kg	Retail box: 12	Oldart.no. -	



- High quality blade that lasts longer.
- Built-in, easy-to-use sharpener.
- Sheath reversible for right- or left-handed use.

Universal Knife with Sharpener (orange)					Art.no. 1023618	EAN 6 411501 560179
Height: 28 cm	Length: 3,6 cm	Width: 8 cm	Weight: 0,13 kg	Retail box: 8	Oldart.no. -	



- High quality blade for general use.
- Built-in, easy-to-use sharpener.
- Sheath reversible for right- or left-handed use.
- 3-component ergonomic handle (patented).
- Stainless steel.

Heavy duty Knife with Sharpener (green)					Art.no. 1023619	EAN 6 411501 560186
Height: 28 cm	Length: 3,6 cm	Width: 8 cm	Weight: 0,15 kg	Retail box: 8	Oldart.no. -	



- Stronger and thicker blade for heavy use.
- Works also as deburring file.
- Built-in, easy-to-use sharpener.
- Sheath reversible for right- or left-handed use.
- 3-component ergonomic handle (patented).

Craftsman's Knife with Sharpener (red)					Art.no. 1023620	EAN 6 411501 560193
Height: 28 cm	Length: 3,6 cm	Width: 8 cm	Weight: 0,12 kg	Retail box: 8	Oldart.no. -	



- Shorter blade for more precision.
- Built-in, easy-to-use sharpener.
- Sheath reversible for right- or left-handed use.
- 3-component ergonomic handle (patented).

Carpenter's Knife with Sharpener (yellow)					Art.no. 1023621	EAN 6 411501 560209
Height: 28 cm	Length: 3,6 cm	Width: 8 cm	Weight: 0,15 kg	Retail box: 8	Oldart.no. -	



- High quality chisel blade.
- Built-in, easy-to-use sharpener.
- Sheath reversible for right- or left-handed use.
- 3-component ergonomic handle (patented).

Other Knives | Fixed Blades

Mineral Wool Knife (K20)					Art.no. 1001626	 EAN 6 411 502 879 027
Height: 42cm	Length: 1,8cm	Width: 3,8cm	Weight: 0,14kg	Retailbox: 4	Oldart.no. -	



• Ideal for cutting insulating materials such as mineral wool or polystyrene.



Tough,
relentless
cuts

PowerGear™

Utilise more of your strength

Patented PowerGear™ technology gives you over 40% more power, making it easier to cut sheet metal, especially at the beginning of the cut where more force is required.

Optimised handle span

Fits your grip, letting you apply more power without sacrificing cut length.

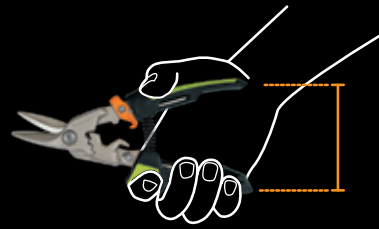

A tool for every task

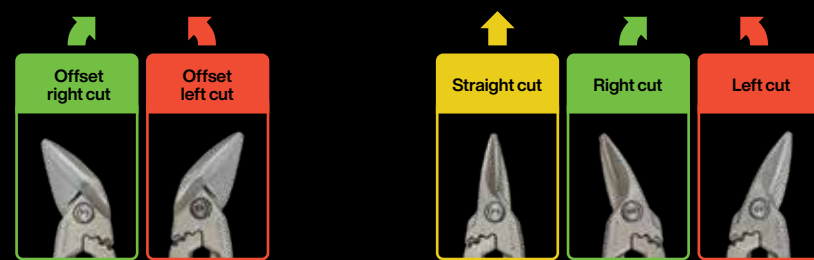

Offset aviation snips allow you to keep your hand on top of the sheet for cuts through the center of the sheet. These tools cut at a sharper angle, distancing your hands from sharp, jagged work surfaces.

Ideal for cutting a range of heavy-duty materials.



Shorter cut length increases cutting capacity.

PowerGear™

40% MORE POWER

Aviation Snips

Fiskars Pro PowerGear™ aviation snips are ideal for cutting a range of heavy-duty materials, including sheet metal, ductwork, drywall corners, metal studs, siding, soffit, fascia, drip edge, gutters and more.

Equipped with PowerGear™ patented technology, these tools feature leverage-enhancing gears that give you over 40% more power, especially during the toughest part of the cut.

PowerGear™ Aviation Snips (straight cut)						Art.no. 1027207	EAN 6 411501 701251
Height: 29,5 cm	Length: 2,5 cm	Width: 10,2 cm	Weight: 0,43 kg	Retail box: 8	Old art.no. -		



Retail pack



- Forged, heat-treated steel blades and handle are 40% stronger for long life and durability.
- EasyAction™ handle with optimized span truly fits your grip, for more power without sacrificing cut length.
- Ergonomic, spring-assisted, SoftGrip™ handle reduces hand fatigue and enhances dexterity.
- Cut capacity: 18-gauge cold-rolled steel, 22-gauge stainless steel; cut length: 38.1mm.

PowerGear™ Aviation Snips (right cut)						Art.no. 1027208	EAN 6 411501 701268
Height: 29 cm	Length: 2,5 cm	Width: 10,2 cm	Weight: 0,44 kg	Retail box: 8	Old art.no. -		



Retail pack



- Forged, heat-treated steel blades and handle are 40% stronger for long life and durability.
- EasyAction™ handle with optimized span truly fits your grip, for more power without sacrificing cut length.
- Ergonomic, spring-assisted, SoftGrip™ handle reduces hand fatigue and enhances dexterity.
- Cut capacity: 18-gauge cold-rolled steel, 22-gauge stainless steel; cut length: 38.1mm.

PowerGear™ Aviation Snips (left cut)						Art.no. 1027209	EAN 6 411501 701275
Height: 29 cm	Length: 2,3 cm	Width: 10,5 cm	Weight: 0,45 kg	Retail box: 8	Old art.no. -		



Retail pack



- Forged, heat-treated steel blades and handle are 40% stronger for long life and durability.
- EasyAction™ handle with optimized span truly fits your grip, for more power without sacrificing cut length.
- Ergonomic, spring-assisted, SoftGrip™ handle reduces hand fatigue and enhances dexterity.
- Cut capacity: 18-gauge cold-rolled steel, 22-gauge stainless steel; cut length: 38.1mm.

PowerGear™ Aviation Snips (offset right cut)						Art.no. 1027210	EAN 6 411501 701282
Height: 29,5 cm	Length: 3,5 cm	Width: 10,5 cm	Weight: 0,49 kg	Retail box: 6	Old art.no. -		



Retail pack



- Forged, heat-treated steel blades and handle are 40% stronger for long life and durability.
- EasyAction™ handle with optimized span truly fits your grip, for more power without sacrificing cut length.
- Ergonomic, spring-assisted, SoftGrip™ handle reduces hand fatigue and enhances dexterity.
- Cut capacity: 18-gauge cold-rolled steel, 22-gauge stainless steel; cut length: 38.1mm.

PowerGear™ Aviation Snips (offset left cut)

Height: 29,5cm Length: 3,5cm Width: 10,5cm Weight: 0,48kg Retail box: 6

Art.no. 1027211

Oldart.no. -



Retail pack



- Forged, heat-treated steel blades and handle are 40% stronger for long life and durability.
- EasyAction™ handle with optimized span truly fits your grip, for more power without sacrificing cut length.
- Ergonomic, spring-assisted, SoftGrip™ handle reduces hand fatigue and enhances dexterity.
- Cut capacity: 18-gauge cold-rolled steel, 22-gauge stainless steel; cut length: 38.1mm.

PowerGear™ Aviation Snips (bulldog)

Height: 29,3cm Length: 2,5cm Width: 10,2cm Weight: 0,43kg Retail box: 8

Art.no. 1027212

Oldart.no. -



Retail pack



- Forged, heat-treated steel blades and handle are 40% stronger, while a shorter cut length increases cutting capacity.
- EasyAction™ handle with optimized span truly fits your grip, for more power without sacrificing cut length.
- Ergonomic, spring-assisted, SoftGrip™ handle reduces hand fatigue and enhances dexterity.
- Cut capacity: 16-gauge cold-rolled steel, 18-gauge stainless steel; cut length: 25.4 mm.

Aviation Snips

Forged, heat-treated steel construction from blade to handle for long life and durability



Extended, forged blade tang improves leverage and strength

Soft Grip™ Handles with strategic texturing for enhanced comfort & control



PowerGear™

40% MORE POWER

EasyAction™ handle opens automatically to reduce fatigue

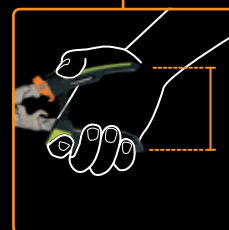

Limited handle opening Prevents over-extension without sacrificing cut length

Outperforms leading competitors



PowerArc™

Intelligent mechanics
 Patentend technology
 features curved blades for
 up to 40 % more power.

PowerArc™

**30%
 MORE
 POWER**

Heavy-duty Scissors

Fiskars Pro heavy-duty scissors feature power-enhancing technologies, such as PowerArc™ for up to 30% more power, and Amplify™ that cuts up to 2x thicker materials. This makes them ideal for cutting a variety of materials including insulation, duct tape, cardboard, cork, board rope, tar paper, Tyvek, hoses and more. Heavy-duty stainless steel blades power through thick materials without separation, while durable construction and high-quality materials guarantee long life.

PowerArc™ Heavy-duty Scissors, 21 cm					Art.no. 1027204	EAN 6 411501 701220
Height: 26 cm	Length: 10 cm	Width: 22 cm	Weight: 0,20 kg	Retail box: 6	Old art.no. -	



Retail pack



- Heavy-duty coined stainless steel blades power through thick materials without separation and won't rust.
- Serrated blade and extended blade tang improve strength and control.
- Ergonomic handle with SoftGrip™ and strategic texturing enhances comfort.

PowerArc™ Heavy-duty Scissors, 26 cm					Art.no. 1027205	EAN 6 411501 701237
Height: 29,5 cm	Length: 10 cm	Width: 26 cm	Weight: 0,26 kg	Retail box: 6	Old art.no. -	



Retail pack



- Heavy-duty coined stainless steel blades power through thick materials without separation and won't rust.
- Serrated blade and extended blade tang improve strength and control.
- Ergonomic handle with SoftGrip™ and strategic texturing enhances comfort.

PowerArc™ Heavy-duty Utility Snip					Art.no. 1027206	EAN 6 411501 701244
Height: 26,4 cm	Length: 12 cm	Width: 26 cm	Weight: 0,21 kg	Retail box: 6	Old art.no. -	



Retail pack



- Offset Easy Action™ handle opens automatically, cuts from above or below and keeps your hand away from the materials you're cutting.
- Heavy-duty stainless steel blades power through thick materials without separation and won't rust.
- Serrated edge grips slippery materials for better control.
- Handle features SoftGrip™ for enhanced dexterity and comfort.
- Easy-open lock protects the blades during transport and storage.

Amplify™ Scissors, 21 cm					Art.no. 1020224	EAN 6 411508 891580
Height: 22 cm	Length: 2 cm	Width: 8 cm	Weight: 0,11 kg	Retail box: 5	Old art.no. -	



- Ideal for cuts through thick, heavy materials like leather, burlap, carpet, canvas, upholstery and more.
- Amplify™ technology senses blade separation when cutting thick materials, forcing them back together for crisp, clean cuts every time.
- Floating blade tang transfers energy to the torsion bar, which adjusts the blade to its optimal angle.
- Soft-grip handle for comfort and control.
- High quality stainless steel blades hold their sharp edge longer.
- For right-handed.

Amplify™ Scissors, 24 cm					Art.no. 1020223	EAN 6 4 1 1 5 0 8 8 9 1 6 8 9
Height: 25 cm	Length: 2 cm	Width: 9 cm	Weight: 0,17 kg	Retailbox: 5	Oldart.no. -	



- Ideal for cuts through thick, heavy materials like leather, burlap, carpet, canvas, upholstery and much more.
- Premium-grade, stainless steel blades with a precisely-honed edge stay sharp and cut cleanly, all the way to the tip.
- Thumb and finger loops with ergonomic sculpting for exceptional comfort and control.
- Soft-grip handle for comfort and control.
- High quality stainless steel blades hold their sharp edge longer.
- For right-handed.

Hardware Scissors, 25 cm					Art.no. 1020478	EAN 3 3 5 9 9 0 0 6 9 9 6 3 8
Height: 32 cm	Length: 2 cm	Width: 9 cm	Weight: 0,13 kg	Retailbox: 6	Oldart.no. -	



- MADE IN FINLAND**
- Long high-quality stainless steel blades with wire cutting notch.
 - Large ergonomic handle.
 - Ergonomic and durable design.
 - Made in Finland.
 - For right-handed.

Classic Hardware Scissors

Large universal purpose scissors 25 cm, hardware					Art.no. 1024882	EAN 3 3 5 9 9 0 0 3 9 8 6 3 0
Height: 31 cm	Length: 2,2 cm	Width: 11 cm	Weight: 0,16 kg	Retailbox: 5	Oldart.no. -	



MADE IN FINLAND

- One billion scissors sold.
- Ideal for all kinds of fixing cutting tasks such as cutting cardboard, wallpaper and packaging.
- Superior comfort and performance.
- Long stainless steel blades. HRC 57.
- Handles made from impact-resistant PBT.
- Adjustable blade tension.
- Made in Finland with premium and durable materials, tested by hand.
- For right-handed.

Universal purpose scissors 21 cm, hardware					Art.no. 1024880	EAN 3 3 5 9 9 0 0 3 9 8 5 3 1
Height: 28 cm	Length: 2 cm	Width: 8,6 cm	Weight: 0,09 kg	Retailbox: 5	Oldart.no. -	



MADE IN FINLAND

- One billion scissors sold.
- Ideal for all kinds of fixing cutting tasks such as cutting cardboard, wallpaper and packaging.
- Superior comfort and performance.
- Handles made from impact-resistant PBT.
- Adjustable blade tension.
- Made in Finland with premium and durable materials, tested by hand.
- For right-handed.

Universal purpose scissors 21 cm, left-handed, hardware					Art.no. 1024886	EAN 3 3 5 9 9 0 0 3 9 9 5 0 7
Height: 28 cm	Length: 2 cm	Width: 8,6 cm	Weight: 0,09 kg	Retailbox: 5	Oldart.no. -	



MADE IN FINLAND

- One billion scissors sold.
- Ideal for all kinds of cutting tasks in and around the home.
- Superior comfort and performance.
- Adjustable blade tension.
- Made in Finland with premium and durable materials, tested by hand.
- For left-handed.

Small universal purpose scissors 17 cm, hardware					Art.no. 1024881	EAN 3 3 5 9 9 0 0 3 9 8 5 9 3
Height: 24,7 cm	Length: 1,5 cm	Width: 8,5 cm	Weight: 0,05 kg	Retailbox: 10	Oldart.no. -	



MADE IN FINLAND

- One billion scissors sold.
- Ideal for all kinds of cutting tasks in and around the home.
- Superior comfort and performance.
- Made in Finland with premium and durable materials, tested by hand.
- For right- and left-handed.

Extra-thick stainless steel blades
Power through thick materials. Blade tangs extend into the handles providing improved leverage and strength during tough cuts

Stronger coined blades
Help prevent blade separation when cutting thicker materials

Amplify™
2X CUT THICKER MATERIALS

With Amplify™ power enhancing technology Cut 2x thicker materials

PowerArc™

30% MORE POWER

PowerArc™ technology
Patent-pending blade technology that makes cutting easier, especially at the end of the cut where more force is required

Bigger loops
optimised for large gloved hands

Soft Grip™
Ergonomic handle with SoftGrip™ enhances comfort and control

Serrated blade edge
grips slippery materials for better control

PowerGear™ Bolt Cutters

Cut a range of heavy-duty materials including padlocks, chains, rebar, metal rods, threaded rods and more.



Forged, heat-treated blades
Stay sharp even through heavy use

Soft Grip™

Ergonomic handles with SoftGrip™ enhances comfort and control

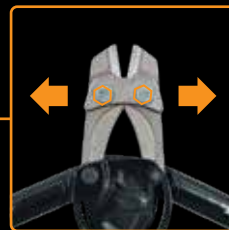

Adjustable bolts optimise jaw alignment to maintain cut performance

PowerGear™

40% MORE POWER

PowerGear™ patented technology
Makes cutting hardened rod up to 30% easier, especially at the beginning of the cut where more force is required

Bolt Cutters

Ideal for cutting a range of heavy-duty materials including paddle locks, chains, rebar, metal rod, threaded rod and more, Fiskars Pro Bolt cutters feature PowerGear™ patented technology - leverage-enhancing gears that give you over 40% more power, especially during the toughest part of the cut. Adjustable eccentric bolts allow you to optimize jaw alignment for optimal cut performance over time.

PowerGear™ Bolt Cutter, 91 cm

Height: 92 cm | Length: 5,5 cm | Width: 32 cm | Weight: 5,5 kg | Retail box: 1

Art.no. 1027216



• Cutting capacity: Cuts soft materials up to 12,7 mm (1/2") (<19 HRC) and hard materials up to 9,5 mm (3/8") (<40 HRC).
• Length: 91 cm

PowerGear™ Bolt Cutter, 76 cm

Height: 75 cm | Length: 5 cm | Width: 29 cm | Weight: 4,45 kg | Retail box: 1

Art.no. 1027215



• Cutting capacity: Cuts soft materials up to 11,1 mm (7/16") (<19 HRC) and hard materials up to 7,9 mm (5/16") (<40 HRC).
• Length: 76 cm

PowerGear™ Bolt Cutter, 61 cm

Height: 61,5 cm | Length: 4,5 cm | Width: 21 cm | Weight: 3,06 kg | Retail box: 2

Art.no. 1027214



• Cutting capacity: Cuts soft materials up to 9,5 mm (3/8") (<19 HRC) and hard materials up to 6,35 mm (1/4") (<40 HRC).
• Length: 61 cm

PowerGear™ Bolt Cutter, 36 cm

Height: 35,5 cm | Length: 4 cm | Width: 14,5 cm | Weight: 1,08 kg | Retail box: 2

Art.no. 1027213



• Cutting capacity: Cuts soft materials up to 7,9 mm (5/16") (<19 HRC) and hard materials up to 4,76 mm (3/16") (<40 HRC).
• Length: 36 cm

IsoCore™

Reduce punishment on your body
Patented technology reduces strike shock and vibration up to 70%, reducing muscle fatigue and joint pain.

Built to last longer
Forged, heat-treated steel head, finished with a rust-resistant coating.

Maximum strike control
Ergonomically contoured grip and perfectly balanced shaft to give the ultimate strike feel.

IsoCore™

UP TO
70%
LESS
SHOCK



Sledge Hammers

Patented IsoCore™ Shock Control System transfers 2x less shock and vibration than wood handles, reducing the punishment your body takes

5x more destructive
Induction-hardened, wedge-shaped demolition head concentrates force for maximum destruction, directing debris to the sides and away from the user

Inseparable riveted head
Stainless steel riveted head with steel-reinforced core gives our product unmatched head retention and durability



Driving face
Induction hardened extra-large diameter improves strike accuracy. Larger than competition.



Forged, heat-treated steel with rust-resistant coating



Strategic texturing improves grip & helps prevent blisters



IsoCore™ Shock-absorbing insulation sleeve with overstrike protection

Handle flare keeps tool firmly in hand

IsoCore™

50%
LESS
SHOCK

Striking Tools

IsoCore™ L Sledge Hammer					Art.no. 1020219	EAN 6 411501 560063
Height: 92,1cm	Length: 7,6cm	Width: 15,9cm	Weight: 4,76kg	Retail box: 2	Oldart.no. -	



reddot award 2016 winner



- Wedged demolition face concentrates force for up to 5x more destructive power.
- Inseparable riveted head will not slide down or snap off.
- Forged, heat-treated steel with rust-resistant coating.
- Extra-large diameter driving face improves strike accuracy.
- Handle flare keeps the tool firmly in hand when swinging.
- Insulation sleeve captures initial strike shock.
- Dual-layer handle features insulating materials to dampen lingering vibration.
- Steel-jacketed core improves handle strength.
- Sculpted SoftGrip™ handle for enhanced comfort and control.

IsoCore™ XL Sledge Hammer					Art.no. 1020164	EAN 6 411501 560070
Height: 92,1cm	Length: 8,3cm	Width: 17,8cm	Weight: 5,67kg	Retail box: 2	Oldart.no. -	



reddot award 2016 winner



- Wedged demolition face concentrates force for up to 5x more destructive power.
- Inseparable riveted head will not slide down or snap off.
- Forged, heat-treated steel with rust-resistant coating.
- Extra-large diameter driving face improves strike accuracy.
- Handle flare keeps the tool firmly in hand when swinging.
- Insulation sleeve captures initial strike shock.
- Dual-layer handle features insulating materials to dampen lingering vibration.
- Steel-jacketed core improves handle strength.
- Sculpted SoftGrip™ handle for enhanced comfort and control.

IsoCore™ M Club Hammer					Art.no. 1020217	EAN 6 411501 560049
Height: 28,6cm	Length: 5,7cm	Width: 12,1cm	Weight: 1,63kg	Retail box: 2	Oldart.no. -	



reddot award 2016 winner



- Wedged demolition face concentrates force for up to 5x more destructive power.
- Extra-large diameter driving face improves strike accuracy.
- Forged, heat-treated steel with rust-resistant coating.
- Sculpted SoftGrip™ handle for enhanced comfort and control.
- Handle flare keeps tool firmly in hand when swinging.
- Strategic handle texturing for maximum grip helps prevent blisters.
- Insulation sleeve captures initial strike shock.
- Dual-layer handle features insulating materials to dampen lingering vibration.

IsoCore™ L Club Hammer					Art.no. 1020218	EAN 6 411501 560056
Height: 36,2cm	Length: 5,7cm	Width: 14cm	Weight: 2,18kg	Retail box: 2	Oldart.no. -	



reddot award 2016 winner



- Wedged demolition face concentrates force for up to 5x more destructive power.
- Extra-large diameter driving face improves strike accuracy.
- Forged, heat-treated steel with rust-resistant coating.
- Sculpted SoftGrip™ handle for enhanced comfort and control.
- Handle flare keeps tool firmly in hand when swinging.
- Strategic handle texturing for maximum grip helps prevent blisters.
- Insulation sleeve captures initial strike shock.
- Dual-layer handle features insulating materials to dampen lingering vibration.

IsoCore™ XXL Builder's Axe					Art.no. 1020220	EAN 6 411501 560087
Height: 92,1cm	Length: 7,6cm	Width: 20,3cm	Weight: 4,23kg	Retail box: 2	Oldart.no. -	



reddot award 2016 winner



- Optimized blade geometry blasts tough logs apart while the driving face can be struck with another tool to force the wedge.
- Inseparable riveted head will not slide down or snap off.
- Forged, heat-treated steel with rust-resistant coating.
- Driving face can be struck with another tool during splitting to help force the wedge.
- Handle flare keeps tool firmly in hand when swinging.
- Strategic handle texturing for maximum grip helps prevent blisters.
- Insulation sleeve captures initial strike shock.

Industry's leading shock control system



Striking Tools

IsoCore™ L Pick					Art.no. 1020166	EAN 6 411501 560094
Height: 91,36 cm	Length: 9 cm	Width: 46,89 cm	Weight: 3,4 kg	Retailbox: 2	Oldart.no. -	



- Head features a pick end for driving through hard surfaces and mattock end for use as a hoe in tough soil.
- Inseparable riveted head will not slide down or snap off.
- Forged, heat-treated steel with rust-resistant coating.
- Sculpted SoftGrip™ handle for enhanced comfort and control.
- Patent-pending, strategic handle texturing features large finger dimples for maximum grip and small dimples where the palm rests to prevent blisters.
- Insulation sleeve captures initial strike shock.

IsoCore™ S Pick					Art.no. 1062937	EAN 6 411501 201201
Height: 36,3 cm	Length: 6,3 cm	Width: 14,6 cm	Weight: 1,2 kg	Retailbox: 2	Oldart.no. -	



- Head features a pick end for driving through hard surfaces and a mattock end for use as a hoe in tough soil.
- Inseparable riveted head will not slide down or snap off.
- Forged, heat-treated steel with rust-resistant coating.
- Sculpted SoftGrip™ handle for enhanced comfort and control.
- Handle texturing improves grip and prevents blisters.

IsoCore™ S Maul					Art.no. 1062936	EAN 6 411501 201195
Height: 35,89 cm	Length: 5,08 cm	Width: 14,30 cm	Weight: 1,36 kg	Retailbox: 2	Oldart.no. -	



- Ideal for splitting small logs and kindling.
- Transfers less shock and vibration than wood-handled mauls, reducing punishment on your body.
- Inseparable riveted head will not slide down or snap off, even when swinging with maximum force.
- Forged, heat-treated steel with rust-resistant coating.

Hammers

IsoCore™ M Finishing Hammer					Art.no. 1020213	EAN 6 411501 560001
Height: 34,3 cm	Length: 3,8 cm	Width: 13,3 cm	Weight: 0,82 kg	Retailbox: 4	Oldart.no. -	



Retail pack



- Ideal for driving small nails into visible surfaces without damaging the surrounding area.
- Sculpted SoftGrip™ handle with texturing helps prevent blisters while improving comfort and control.
- Rip claw pulls nails quickly and easily.
- Insulation sleeve captures initial strike shock.

IsoCore™ M Finishing Hammer, Curved Claw					Art.no. 1027202	EAN 6 411501 701206
Height: 34 cm	Length: 2,8 cm	Width: 13,6 cm	Weight: 0,88 kg	Retailbox: 6	Oldart.no. -	



Retail pack



- Ideal for driving small nails into visible surfaces without damaging the surrounding area.
- Sculpted SoftGrip™ handle with texturing helps prevent blisters while improving comfort and control.
- Curved claw optimised to make removing nails faster and easier.
- Insulation sleeve captures initial strike shock.

IsoCore™ L General Use Hammer					Art.no. 1020214	EAN 6 411501 560018
Height: 34,3 cm	Length: 3,8 cm	Width: 14,6 cm	Weight: 0,91 kg	Retailbox: 4	Oldart.no. -	



Retail pack



- Ideal for driving small nails into visible surfaces without damaging the surrounding area.
- Sculpted SoftGrip™ handle with texturing helps prevent blisters while improving comfort and control.
- Magnetic nail-starter groove allows you to start nails with one hand in hard places.
- Rip claw pulls nails quickly and easily.
- Insulation sleeve captures initial strike shock.

IsoCore™ L General Use Hammer, Curved Claw					Art.no. 1027203	EAN 6 411501 701213
Height: 34 cm	Length: 3,2 cm	Width: 13,4 cm	Weight: 0,78 kg	Retailbox: 6	Oldart.no. -	



Retail pack



- Ideal for driving nails during a wide variety of common tasks on the job site or around the house.
- Sculpted SoftGrip™ handle with texturing helps prevent blisters while improving comfort and control.
- Curved claw optimised to make removing nails faster and easier.
- Insulation sleeve captures initial strike shock.

IsoCore™ XL General Use Hammer					Art.no. 1020215	EAN 6 411501 560025
Height: 39,4 cm	Length: 3,8 cm	Width: 14,6 cm	Weight: 0,86 kg	Retailbox: 4	Oldart.no. -	



Retail pack



- Ideal for driving small nails into visible surfaces without damaging the surrounding area.
- Sculpted SoftGrip™ handle with texturing helps prevent blisters while improving comfort and control.
- Magnetic nail-starter groove allows you to start nails with one hand in hard places.
- Rip claw pulls nails quickly and easily.
- Insulation sleeve captures initial strike shock.

IsoCore™ XXL Milled-faced Framing Hammer					Art.no. 1020216	EAN 6 411501 560032
Height: 40,6 cm	Length: 3,8 cm	Width: 14,6 cm	Weight: 1,02 kg	Retail box: 4	Old art.no. -	



Retail pack



reddot award 2016 winner



- Head optimized for balance, weight and superior durability.
- Handle flare keeps the tool firmly in hand when swinging.
- Sculpted SoftGrip™ handle with texturing helps prevent blisters while improving comfort and control.
- Milled face grips nail head to help prevent hammer from sliding off the nail when striking.
- Magnetic nail-starter groove allows you to start nails with one hand in hard places.
- Rip claw pulls nails quickly and easily.
- Forged, heat-treated steel with rust-resistant coating.
- Extended grip lets you choke up for added control when making precision strikes.
- Insulation sleeve captures initial strike shock.

General Use Hammers



Superior durability

Forged, heat treated steel with rust resistant coating



Optimal weight balance

Unique design allows the distribution of the mass in optimised locations to get the right balance for each hammer in the line

Strategic handle texturing improves grip & helps prevent blisters



Optimised head for balance, weight & superior durability

Handle ergonomics Contoured handle with extended grip to choke up on for starting nails

Hook end More control during swing



Magnetic nail starter on framing & general use hammers



IsoCore™ Shock-absorbing insulation sleeve

Patented IsoCore™ Shock Control System absorbs strike shock and vibration to reduce the punishment your body takes, transferring up to 70 % less shock and vibration than wood handles

IsoCore™
70% LESS SHOCK

Demolition Tools

Fiskars Pro demolition tools are great for a variety of demolishing tasks and feature patented IsoCore™ shock control technology to reduce shock and vibration by up to 70%.

IsoCore™ L Demolition Tool					Art.no. 1027221	EAN 6 411501 701398
Height: 75 cm	Length: 3,5 cm	Width: 15 cm	Weight: 2,60 kg	Retail box: 2	Old art.no. -	



- IsoCore™ shock control system transfers 30% less vibration than wood handles.
- Board bender & straightener to reuse and straighten boards.
- SoftGrip™ handle with texturing for improved grip.
- Chisel & pry to easily remove tile, striking face for pounding.
- Demo edge maximizes striking force.
- Striking & struck face lets you position and strike to target tight spaces.
- Claw for easily pulling nails.

IsoCore™ M Demolition Tool					Art.no. 1027220	EAN 6 411501 701381
Height: 46,2 cm	Length: 3 cm	Width: 14,2 cm	Weight: 1,38 kg	Retail box: 4	Old art.no. -	



- IsoCore™ shock control system transfers 30% less vibration than wood handles.
- Board bender & straightener to reuse and straighten boards.
- SoftGrip™ handle with texturing for improved grip.
- Chisel & pry to easily remove tile.
- Demo edge maximizes striking force.
- Claw for easily pulling nails.
- Handle flare keeps the tool firmly in hand when swinging.

Claw easily pulls nails

Board bender & straightener to move and straighten boards

Soft Grip™ improves grip & helps prevent blisters

Optimised balance, ultimate feel

Forged, heat-treated steel with rust-resistant coating

IsoCore™ Shock-absorbing insulation sleeve

Handle flare keeps tool firmly in hand

IsoCore™
30% LESS SHOCK

Iron bars

Iron Bar, 5 kg					Art.no. 1027234	EAN 6 411501 701527
Height: 120 cm	Length: 2,9 cm	Width: 2,9 cm	Weight: 4,97 kg	Retailbox: 1	Oldart.no. -	

- For levering, moving loads, dislodging stones & digging.
- Octagonal cross-section for better grip.
- Made of high quality & durable carbon steel.
- Hardened ends to ensure user safety when using the bar to strike.

Iron Bar, 6 kg					Art.no. 1027235	EAN 6 411501 701534
Height: 135 cm	Length: 3 cm	Width: 3 cm	Weight: 5,97 kg	Retailbox: 1	Oldart.no. -	

- For levering, moving loads, dislodging stones & digging.
- Octagonal cross-section for better grip.
- Made of high quality & durable carbon steel.
- Hardened ends to ensure user safety when using the bar to strike.

Iron Bar, 7 kg					Art.no. 1027236	EAN 6 411501 701541
Height: 150 cm	Length: 3,1 cm	Width: 3,1 cm	Weight: 7,01 kg	Retailbox: 1	Oldart.no. -	

- For levering, moving loads, dislodging stones & digging.
- Octagonal cross-section for better grip.
- Made of high quality & durable carbon steel.
- Hardened ends to ensure user safety when using the bar to strike.

Maintenance & Spare parts

Maintenance [p.272](#)

Spare parts [p.272](#)

Maintenance | Spare Parts

Maintenance Kit					Art.no. 1001640	EAN 6 4 1 1 5 0 1 9 6 9 9 0 3
Height: 19,7cm	Length: 3,3cm	Width: 10,5cm	Weight: 0,15kg	Retailbox: 4	Oldart.no. 110990	



- For regular maintenance on Fiskars garden tools.
- Includes a maintenance guidebook, diamond file and oil.
- Detailed instructions using pictures and symbols for sharpening, oiling, washing, storage and more.

Spare Blade For Folding Saw SW68					Art.no. 1067554	EAN 6 4 1 1 5 0 1 2 0 1 3 5 5
Height: 23,4cm	Length: 0,4cm	Width: 8cm	Weight: 0,06kg	Retailbox: 4	Oldart.no. -	



- SW-68 (1067552)
- For quick, clean cuts on thick stems and branches.
- 7 TPI blade for fast cutting.
- Blade length: 15 cm

Spare Blade For Folding Saw SW69					Art.no. 1067555	EAN 6 4 1 1 5 0 1 2 0 1 3 6 2
Height: 29,4cm	Length: 0,4cm	Width: 8cm	Weight: 0,08kg	Retailbox: 4	Oldart.no. -	



- SW-69 (1067553)
- For quick, clean cuts on thick stems and branches.
- 7 TPI blade for fast cutting.
- Blade length: 20 cm

Handle Kit for Pruning Saw (SW240 & SW330)					Art.no. 1020202	EAN 6 4 1 1 5 0 1 2 3 3 3 2 5
Height: 22cm	Length: 2,2cm	Width: 11cm	Weight: 0,16kg	Retailbox: 4	Oldart.no. 123332	



- Handle kit for use with:
- SW-330 (article No 1020199).
- SW-240 (article No 1020200).
- Sturdy grip with SoftGrip™.
- Screw and nut.

Scabbard Kit for Pruning Saw (SW240 & SW330)					Art.no. 1020201	EAN 6 4 1 1 5 0 1 2 3 3 3 1 8
Height: 42cm	Length: 5,5cm	Width: 9cm	Weight: 0,18kg	Retailbox: 4	Oldart.no. 123331	



- Scabbard kit for use with:
- SW-330 (article No 1020199).
- SW-240 (article No 1020200).
- Scabbard with left- and right-side mounting.
- Usable with WoodXpert™ tool belt (Article No 1003626).

Curved Replacement Blade (CC33)					Art.no. 1020193	EAN 6 4 1 1 5 0 1 2 3 3 3 6 3
Height: 43,4cm	Length: 0,3cm	Width: 7,1cm	Weight: 0,10kg	Retailbox: 4	Oldart.no. 123336	



- Replacement blade for use with:
- SW-330 (article No 1020199).
- SW-240 (article No 1020200).
- General cutting, fast pruning with fewer strokes.
- Pitch of teeth 4 mm.

Straight Replacement Blade (SC33)					Art.no. 1020195	EAN 6 4 1 1 5 0 1 2 3 3 3 7 0
Height: 43,4cm	Length: 0,3cm	Width: 7,1cm	Weight: 0,08kg	Retailbox: 4	Oldart.no. 123337	



- Replacement blade for use with:
- SW-330 (article No 1020199).
- SW-240 (article No 1020200).
- Felling cuts.
- Pitch of teeth 4 mm.

Straight Replacement Blade (SF33)					Art.no. 1020197	EAN 6 4 1 1 5 0 1 2 3 3 3 8 7
Height: 43,4cm	Length: 0,3cm	Width: 7,1cm	Weight: 0,09kg	Retailbox: 4	Oldart.no. 123338	



- Replacement blade for use with:
- SW-330 (article No 1020199).
- SW-240 (article No 1020200).
- Fruit trees and trees with loose bark.
- Pitch of teeth 2,5 mm.

Curved Replacement Blade (CC24)					Art.no. 1020194	EAN 6 4 1 1 5 0 1 2 3 2 4 6 5
Height: 34cm	Length: 0,3cm	Width: 5,3cm	Weight: 0,06kg	Retailbox: 4	Oldart.no. 123246	



- Replacement blade for use with:
- SW-330 (article No 1020199).
- SW-240 (article No 1020200).
- General cutting.
- Pitch of teeth 4 mm.

Straight Replacement Blade (SC24)					Art.no. 1020196	EAN 6 4 1 1 5 0 1 2 3 2 4 7 2
Height: 34cm	Length: 0,3cm	Width: 5,3cm	Weight: 0,06kg	Retailbox: 4	Oldart.no. 123247	



- Replacement blade for use with:
- SW-330 (article No 1020199).
- SW-240 (article No 1020200).
- Root cuts.
- Pitch of teeth 4 mm.

Straight Replacement Blade (SF24)					Art.no. 1020198	EAN 6 411501 232489
Height: 34cm	Length: 0,3cm	Width: 5,3cm	Weight: 0,07kg	Retailbox: 4	Oldart.no. 123248	



Replacement blade for use with:
 • SW-330 (article No 1020199).
 • SW-240 (article No 1020200).
 • Fruit trees and trees with loose bark.
 • Pitch of teeth 2,5mm.

Spare Blade for Bow Saw (SW30)					Art.no. 1001706	EAN 0 046561 100674
Height: 63cm	Length: 0,1cm	Width: 4cm	Weight: 0,05kg	Retailbox: 5	Oldart.no. 124807	



Replacement blade for use with:
 • 21" Bow Saw SW30 (article No 1001621).

Spare Blade for Bow Saw (SW31)					Art.no. 1001707	EAN 0 046561 100681
Height: 67,1cm	Length: 0,1cm	Width: 4cm	Weight: 0,05kg	Retailbox: 5	Oldart.no. 124817	



Replacement blade for use with:
 • 24" Bow Saw SW31 (article No 1000615).

Blade, spring, screw (P961)					Art.no. 1064258	EAN 6 411501 704382
Height: 27cm	Length: 3,5cm	Width: 17cm	Weight: 0,07kg	Retailbox: 4	Oldart.no. -	



Blade, spring, screw for use with:
 • X-series Pruner bypass L P961 (article No 1057175).

Blade, spring, screw (P941)					Art.no. 1064259	EAN 6 411501 704399
Height: 27cm	Length: 3,5cm	Width: 17cm	Weight: 0,06kg	Retailbox: 4	Oldart.no. -	



Blade, spring, screw for use with:
 • X-series Pruner anvil L P941 (article No 1057174).

Blade, spring, screw (P921)					Art.no. 1064260	EAN 6 411501 704405
Height: 27cm	Length: 3,5cm	Width: 17cm	Weight: 0,06kg	Retailbox: 4	Oldart.no. -	



Blade, spring, screw for use with:
 • X-series Pruner bypass M P921 (article No 1057173).

Blade, Spring, Screw (PX92)					Art.no. 1026275	EAN 6 424002 008491
Height: 27cm	Length: 3,5cm	Width: 17cm	Weight: 0,06kg	Retailbox: 4	Oldart.no. -	



Blade, spring, screw for use with:
 • PGX Pruner bypass M PX92 (article No 1023630).

Blade, Spring, Screw (PX93)					Art.no. 1026276	EAN 6 424002 008507
Height: 27cm	Length: 3,5cm	Width: 17cm	Weight: 0,06kg	Retailbox: 4	Oldart.no. -	



Blade, spring, screw for use with:
 • PGX Pruner anvil L PX93 (article No 1023629).

Blade, Spring, Screw (PX94)					Art.no. 1026277	EAN 6 424002 008514
Height: 27cm	Length: 3,5cm	Width: 17cm	Weight: 0,07kg	Retailbox: 4	Oldart.no. -	



Blade, spring, screw for use with:
 • PGX Pruner bypass L PX94 (article No 1023628).

Blade, Spring, Bolt, Screw (P90)					Art.no. 1026278	EAN 6 424002 008521
Height: 27cm	Length: 3,5cm	Width: 17cm	Weight: 0,10kg	Retailbox: 4	Oldart.no. -	



Blade, spring, bolt, screw for use with:
 • Pro Pruner P90 (article No 1001530).

Blade, Spring, Screw (P100)					Art.no. 1026279	EAN 6 424002 008538
Height: 27cm	Length: 2,5cm	Width: 17cm	Weight: 0,05kg	Retailbox: 4	Oldart.no. -	



Blade, spring, screw for use with:
 • Quantum Pruner bypass P100 (article No 1001434).

Blade, Lock, Screw Kit, M & L (PB8)					Art.no. 1026280	EAN 6 424002 008545
Height: 27cm	Length: 2cm	Width: 17cm	Weight: 0,12kg	Retailbox: 4	Oldart.no. -	



Blade, lock, screw kit for use with:
 • Pro Tools Pruner PB8 M (article No 1020204).
 • Pro Tools Pruner PB8 L (article No 1020203).

Blade Kit PTFE, M & L (PB8)					Art.no. 1026281	EAN 6 424002 008552
Height: 27cm	Length: 1,2cm	Width: 17cm	Weight: 0,04kg	Retailbox: 4	Oldart.no. -	



Blade kit PTFE for use with:
 • Pro Tools Pruner PB8 M (article No 1020204).
 • Pro Tools Pruner PB8 L (article No 1020203).

Handle Kit, M (PB8)					Art.no. 1026282	EAN 6 424002 008569
Height: 27cm	Length: 2,2cm	Width: 17cm	Weight: 0,08kg	Retailbox: 4	Oldart.no. -	



Handle kit for use with:
 • Pro Tools Pruner PB8 M (article No 1020204).

Handle Kit, L (PB8)					Art.no. 1026283	EAN 6 424002 008576
Height: 27cm	Length: 2,5cm	Width: 17cm	Weight: 0,09kg	Retailbox: 4	Oldart.no. -	



Handle kit for use with:
 • Pro Tools Pruner PB8 L (article No 1020203).

Blade, Screws (L102, L72, L76)					Art.no. 1026284	EAN 6 424002 008583
Height: 27cm	Length: 2cm	Width: 17cm	Weight: 0,14kg	Retailbox: 4	Oldart.no. -	



Blade, screws for use with:
 • Quantum Lopper bypass Scissor SL102 (article No 1001436).
 • PowerGear Lopper bypass Scissor SL72 (article No 1001555).
 • PowerGear Lopper bypass Scissor M L76 (article No 1001553).

Blade, Screws (L104, L108, LX94, LX98, L78, L94, L98)					Art.no. 1026285	EAN 6 424002 008590
Height: 27cm	Length: 2,6cm	Width: 17cm	Weight: 0,29kg	Retailbox: 4	Oldart.no. -	



Blade, screws for use with:
 • Quantum Lopper bypass M L104 (article No 1001438) and bypass L L108 (article No 1001435).
 • PGX Lopper bypass M LX94 (article No 1020187) and bypass L LX98 (article No 1020188).
 • PowerGear Lopper bypass Hook L L78 (article No 1000584).
 • PowerGear Steel Lopper bypass M L94 (article No 1001549) and bypass L L98 (article No 1001548).

Blades Anvil, Screw (L109, LX99, L93, L99)					Art.no. 1026286	EAN 6 424002 008606
Height: 27cm	Length: 2,2cm	Width: 17cm	Weight: 0,25kg	Retailbox: 4	Oldart.no. -	



Blades anvil, screw for use with:
 • Quantum Lopper anvil L L109 (article No 1001437).
 • PGX Lopper anvil L LX99 (article No 1020189).
 • PowerGear Steel Lopper Anvil M L93 (article No 1001550).
 • PowerGear Steel Lopper Anvil L L99 (article No 1001547).

Blade, Screw (L70, L74, L90, L92, LX92)					Art.no. 1026288	EAN 6 424002 008620
Height: 27cm	Length: 2cm	Width: 17cm	Weight: 0,14kg	Retailbox: 4	Oldart.no. -	



Blade, screw for use with:
 • PowerGear Lopper bypass Hook Head SL70 (article No 1002104).
 • PowerGear Lopper bypass Hook ML74 (article No 1000582).
 • PowerGear Steel Lopper bypass XS L90 (article No 1001552).
 • PowerGear Steel Lopper bypass SL92 (article No 1001551).
 • PGX Lopper bypass SLX92 (article No 1020186).

Blades, Anvil, Screw (L71)					Art.no. 1026290	EAN 6 424002 008644
Height: 27cm	Length: 2,5cm	Width: 17cm	Weight: 0,18kg	Retailbox: 4	Oldart.no. -	



Blades, anvil, screw for use with:
 • PowerGear Lopper anvil SL71 (article No 1001556).

Blades, Anvil, Screw (L77)					Art.no. 1026292	EAN 6 424002 008668
Height: 27 cm	Length: 3,1 cm	Width: 17 cm	Weight: 0,37 kg	Retail box: 4	Old art.no. -	



Blades, anvil, screw for use with:
 • PowerGear Lopper anvil L77 (article No 1000583).

Blade, Spring, Chain link for Tree pruners					Art.no. 1026293	EAN 6 424002 008675
Height: 27 cm	Length: 2,2 cm	Width: 17 cm	Weight: 0,07 kg	Retail box: 4	Old art.no. -	



Blade, spring, chain link for use with:
 • PowerGear Tree pruners UP82 (article No 1001558) / UP84 (article No 1001557) / UP86 (article No 1000598/1073084).
 • PowerGear X Tree pruners UPX82 (article No 1023625) / UPX86 (article No 1023624).

Spare Cutting Head (UPX82, UPX86)					Art.no. 1026295	EAN 6 424002 008699
Height: 24 cm	Length: 8,2 cm	Width: 10 cm	Weight: 0,44 kg	Retail box: 4	Old art.no. -	



Spare cutting head for use with:
 • PGX Tree pruner UPX82 (article No 1023625).
 • PGX Telescopic Tree pruner UPX86 (article No 1023624).

Internal Rope & Roll Cord (UP86)					Art.no. 1027526	EAN 6 411501 150356
Height: 27 cm	Length: 2,6 cm	Width: 17 cm	Weight: 0,12 kg	Retail box: 4	Old art.no. -	



For use with Universal Cutters Tree Pruner Bypass Telescopic UP86 (article No 1000598/1073084).

Internal Rope & Roll Cord (UP82)					Art.no. 1027525	EAN 6 411501 150349
Height: 27 cm	Length: 2,6 cm	Width: 17 cm	Weight: 0,09 kg	Retail box: 4	Old art.no. -	



For use with Universal Cutters Tree Pruner Bypass UP82 (article No 1001558).

Handle and Rope Set (UPX86)					Art.no. 1026296	EAN 6 424002 008705
Height: 24 cm	Length: 8,2 cm	Width: 10 cm	Weight: 0,19 kg	Retail box: 4	Old art.no. -	



Handle and rope set for use with:
 • PGX Telescopic tree pruner UPX86 (article No 1023624).

Handle and Rope Set (UPX82)					Art.no. 1026297	EAN 6 424002 008712
Height: 24 cm	Length: 8,2 cm	Width: 10 cm	Weight: 0,16 kg	Retail box: 4	Old art.no. -	



Handle and rope set for use with:
 • PGX Tree pruner UPX82 (article No 1023625).

QuikDrill™ Plus™ Part, S					Art.no. 1000637	EAN 5 905568 347176
Height: 14,5 cm	Length: 2 cm	Width: 10 cm	Weight: 0,14 kg	Retail box: 2	Old art.no. 134717	



Spare blades for use with:
 • QuikDrill™ Garden Drill S (article No 1000636).
 • Working diameter 100 mm.

QuikDrill™ Plus™ Part, L					Art.no. 1000641	EAN 5 905568 347374
Height: 22 cm	Length: 2 cm	Width: 15 cm	Weight: 0,55 kg	Retail box: 2	Old art.no. 134737	

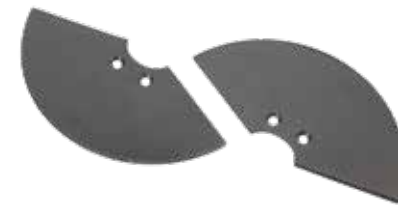

Spare blades for use with:
 • QuikDrill™ Garden Drill L (article No 1000640).
 • Working diameter 200 mm.



Happiness is
seed to
sprout

The right tool for each task

PRUNERS



Solid™ Pruners
1057162



Fingerloop Pruners
1001534



Plus Pruners
1057170



X-series™ Pruners
1057173



PowerGear™ X Tree Pruner
1023625

UNIVERSAL CUTTERS

Universal cutters help you reach difficult spots.

LOPPERS

Loppers are particularly suited for cutting thicker branches.



PowerGear™ Lopper, S
1000581



PowerGear™ X Lopper, M
1020187



PowerGear™ X Lopper, L
1020188

AXES AND SAWS

Saws are particularly suited for removing thick (over Ø 5 cm) branches.



Xtract™ Garden Saw, L
1000614

Axes are good for cutting the thickest branches and splitting firewood.



Chopping Axe (X24 M)
1069104

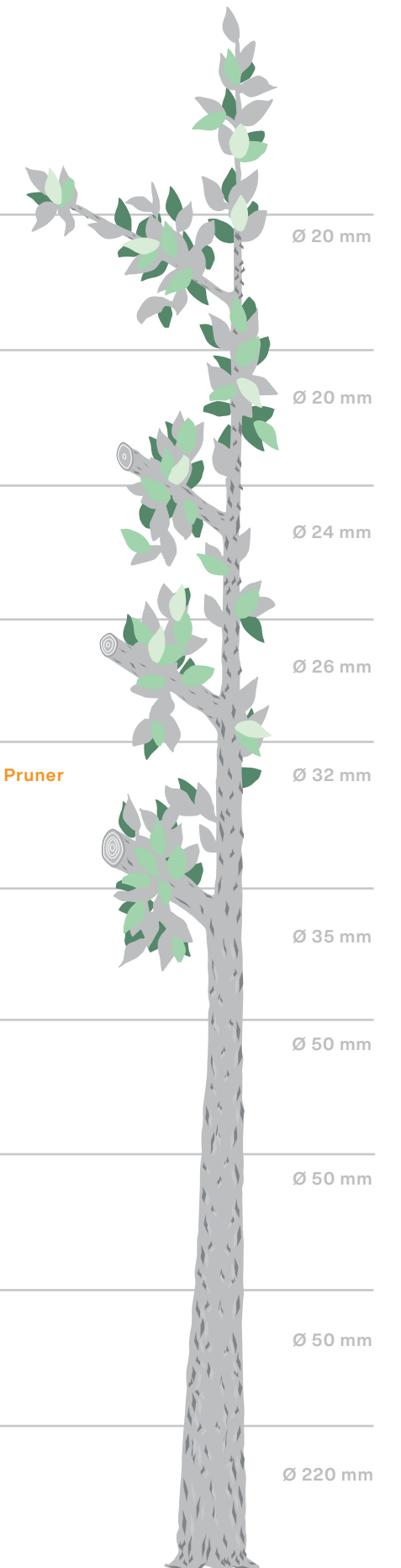

Gardening - general

Made in Finland	Weather proof	Frost resistant	Frost resistant up to -30°C
From S-M sized hands	From S-L sized hands	From M-L sized hands	Left- & right-handed use
Right-handed use only	Pocket fit	Locking system	Double locking system
Cutting diameter	Product size		

Gardening - general materials & technologies

SoftGrip™	TruGrip™	Non-slip	Lightweight	SmartFit™
Steel (Newicon)	Steel	Stainless steel	Boron steel	Steel parts
2X MORE DURABLE	FiberComp™	FiberComp™ (2x more durable)	Aluminium	Dura frame®
Cotton fabric	EaseCut™	Power Step™	Power Gear™ 3X MORE POWER	Power Gear™ 3X MORE POWER
Power Lever™	Power Lever™ MORE POWER	Power Lever™ MORE POWER		

Gardening - plant care maintenance

Maintenance: Wash with water & brush	Maintenance: Wipe with cloth
Maintenance: Oiling connections	Maintenance: Sharpening direction & Fiskars sharpening tool

Spare parts

Spare part symbol	Oil
-------------------	-----

Plant Care

Bypass blades - Promotes growth	Bypass blades function	Anvil blades - Stunts growth	Anvil blades function
Optimised cutting power	Optimised cutting power	Optimised power tip	Non-Stick blade coating
FingerLoop	CrMoV blade material	Ultrablade® coating	TruEdge™ blade
PTFE coating	Coated blade, general	Serrated lower blade	Blade toothing & Sawing direction
Hollow grind blade (branch saw)	Universal snip	For flowers	
Telescopic length	Telescopic max. reach	PowerReel mechanism	

Yard Care

Power Clean™	Power Clean™ usage	Power Clean™ details
--------------	--------------------	----------------------

Car & Snow Tools

Reflectors (sledge)	Double bladed (ice scraper)	Floating (camping & car spade)	Stainless steel (car shovel)
Zinc coated steel edge (sledge)	Non-sticky scoop (sledge)	Telescopic/extendable length	
Boron steel (ice iron)			

Reinforced blade
Stainless steel core

UP TO 3X MORE DURABLE

Lawn Care

180° angle (grass shears)

360° cutting angle (grass shears)

Anti-jamming

Anti-jamming (grass shears)

Weed puller usage: Press into ground

Weed puller usage: Tilt

Weed puller usage: Release

Telescopic length

Pop-up bags sizes

Tear-resistant (Pop-up bags)

Water-resistant (Pop-up bags)

Soil Care

Hardness 52 HRC (hay fork)

Hardness 52 HRC (manure fork)

QuikDrill S, usage 1

QuikDrill S, usage 2

QuikDrill M, usage 1

QuikDrill M, usage 2

QuikDrill L, usage 1

QuikDrill L, usage 2

Aerator rake spike

Flexible prongs (rakes)

Shovel profile

Spade profile

Boron steel (shovels)

Boron steel (pointed spades)

Boron steel (rounded spades)

Step board (spades)

Drop shape shaft (spades)

Construction spade

Double hand usage

Aeration (rakes)

QuikFit™

QuikFit

Universal adapter, connection diameter $\varnothing 12\text{ mm}$

Universal adapter, universal connection

Telescopic reach

Spiker (Sharp blade)

Wood Preparation

Sharp blade (axes)

Chopping axe

Chopping axe for branches

Felling axe

Splitting axe

Splitting log size (axes)

Balanced

Ceramic (axe & knife sharpener)

Push & pull (axe & knife sharpener)

Sharp steel blade (knives)

Blade length

Product length

Sharp blade (brush hooks)

Reinforced (Wood Xpert)

Belt clip (knives)

Dishwasher safe (knives)

Finger guard (knives)

Grafting (knives)

Grafting pen (knives)

Universal usage

Wood carving (knives)

Sappie XA22

Felling lever usage

Log size (log splitter)

Log thongs usage (LT6)

Sappie XA2

Finger guard (bow saws)

Finger guard, D-handle (saws)

Finger guard (saws)

Belt clip (saws)

Maintenance saws: Oiling

Maintenance saws: Wipe with cloth

Push & pull blade (bow saw)

Pull blade, usage (saws)

Pull blade (saws)

Sliding blade (saws)

Special rubber (sledge hammers)

Drop forged (splitting wedge)

Helicoidal (splitting wedge)

Safety warning (axes)

Safety gear

Safety glasses

Safety gloves











Safety instructions (wood prep)

Safe area wedge







Watering - general

 Hose connection diameter 9 mm	 Hose connection diameter 13-15 mm	 Hose connection diameter 19 mm	 Garden size recommendation	 Frost resistant
 Universal fit. Fits with other brands.	 Pressure resistance > XY bar	 Rust resistant	 Rotation capability	

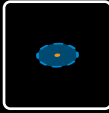
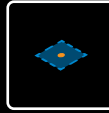
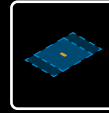
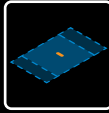
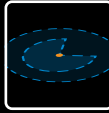

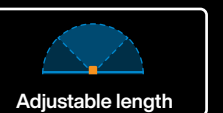

Hoses

 Product length	 UV resistant	 Pressure tested	 Flow control
 Time saving	 70% less water	 Can be cut	 Twist resistancy, level 3
 Twist resistancy, level 4	 Twist resistancy, level 5		



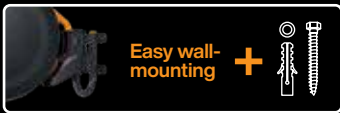







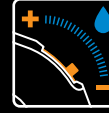

Sprinklers

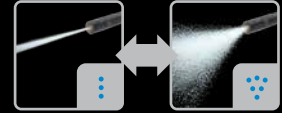
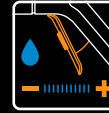
 Watering area S, round	 Watering area S, square	 Watering area M	 Watering area L	 Watering area XL
 20% water saving	 On/Off	 Adjustable distance and rotation	 Adjustable width	 Adjustable area
 Adjustable length				

Waterwheels

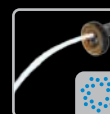
 Easy wall-mounting	 Easy wall-mounting	 Auto On/Off function	 Automatic reel-in function
---	--	--	--



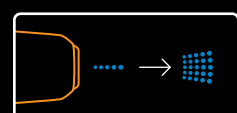
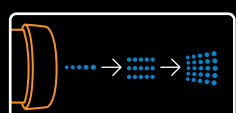
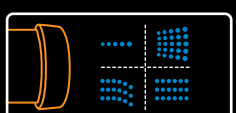



Spray Guns & Nozzles

 Easy to use/connect	 Ergonomic grip pattern	 Water flow	 Water flow	 Water flow, Solid
 Spray pattern, Adjustable, hard to wide	 Front control flow	 Thumb control flow		
 Spray pattern, 3-function, hard jet	 Spray pattern, 3-function, mist	 Spray pattern, 3-function, shower		
 Spray pattern, Multi, bubble spray	 Spray pattern, Multi, flat spray	 Spray pattern, Multi, hard jet	 Spray pattern, Multi, mist	 Spray pattern, Multi, shower
 Spray pattern, Spray gun	 Spray pattern, 3-function	 Spray pattern, 4-function		

Connectors

 Tap connector connection size in inch & mm	 Twin tap, hose On/Off	 Watering stop
--	---	---

Pressure Sprayers & Timers

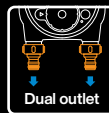
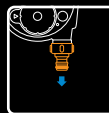
 Up to 5L capacity	 Safety valve	 Timing duration capability 1-360 min	 Auto Off function
 Instant watering	 Watering frequency: every 6h & up to 7 days	 Dual outlet	 Single outlet

FISKARS®



Let your
ideas
grow
wild

Happiness is
[fiskars.com](https://www.fiskars.com)



Fiskars has championed the ageless principles of high quality, intuitive and sustainable design since 1649. We empower every enthusiast to follow their passions and create the life they want. We believe that making our daily activities enjoyable, inspiring and sustainable builds happiness and wellbeing that extends beyond our homes – to our families, our friends, our communities, and our planet.

COOKING | **GARDENING** | CRAFTING