

Index

02	Switchs and Sockets
30	Grup Sockets
35	Installation
74	Kitchen & Bathroom Fans
77	Emergency Lightings
79	Bulkhead Lightings
89	Lighting Products
90	Garden Lightings
91	Automation Products
134	Thermoplastic Box
136	Industrial Type Products

WE SHARE... WE CARE...

With 5V 2.4A energy output, it allows charging your devices quickly and safely like 2 separate tablets, mobile phones etc. however we continue to energize your other devices with earthed socket outlets.

To play
game as you wish...



For your uninterrupted
conversations ...

For your
entertainment



Ritä

For Perfect Solutions ...



SWITCH GROUP (WITH SCREW)												
	2220 401 02XX Oneg. One Way Switch	2220 402 02XX Twog. One Way Control	2220 403 02XX Oneg. Two Way Switch	2220 404 02XX Two Gang Two Way Switch	2220 405 02XX Oneg. One Way Dp	2220 406 02XX Blind Switch -W/Spring	2220 407 02XX One Gang One Way Control	2220 407 02XX Door Switch				
	2220 407 02XXZ Ring Switch	2220 408 02XX Oneg. Intermediate-Deviator	2220 409 02XX 3 Gang Switch	2220 411 02XX Heater Switch	2220 415 02XX Illu.1g.1w.Swi. (220v)	2220 416 02XX Illu.Oneg. Two Way (220v)	2220 417 02XX Illu.1g.1w.Cntrl (220v)	2220 418 02XX Illu.1g.1w.W/Lab. (220v)				
			SWITCH GROUP (EASY CONNEC.)									
	2220 422 02XX Illu.1a.1w.Cntrl (12v)	2220 426 02XX Illu.Twog. One Way Switch		2220 401 01XX Oneg. One Way Switch	2220 402 01XX Twog. One Way Control	2220 403 01XX Oneg. Two Way Switch	2220 404 01XX Two Gang Two Way Switch	2220 405 01XX Oneg. One Way Dp	2220 406 01XX Blind Switch -W/Spring			
	2220 407 01XX One Gang One Way Control	2220 407 01XXK Door Switch		2220 407 01XXZ Ring Switch	2220 408 01XX Oneg. Intermediate-Deviator	2220 409 01XX 3 Gang Switch	2220 415 01XX Illu.1g.1w.Swi. (220v)	2220 416 01XX Illu.Oneg. Two Way (220v)	2220 417 01XX Illu.1g.1w.Cntrl (220v)			
					DIMMER GROUP				ELECTRONICS GROUP			
	2220 419 01XX I.1g.1w.Cntrlw/Lab. (220v)	2220 422 01XX Illu.1g.1w.Cntrl (12v)		2220 426 01XX Illu.Twog. One Way Switch		2220 440 02XX Rotary Dimmer 600W	2220 444 02XX Rotary Dimmer 1000W	2220 447 02XX RC Dimmer 325W		2220 450 01XX Energy Saver Not Delay Illu.		
							SOCKET GROUP					
2220 452 01XX Energy Saver Delay Illu.	2220 470 02XX Audio Switch	2220 480 01XX Speaker Socket		2220 485 02XX Warning Bell		2220 495 02XX Motion Sensor		2220 600 02XX Earthed Socket		2220 601 02XX Non Earthed Socket	2220 605 02XX Earthed Socket (Child Prot.)	
2220 606 02XX Non Earth. Soc. (Child Prot.)	2220 610 02XX Earthed Socket With Cover	2220 611 02XX Earthed Soc. Cover (Child Prot.)		2220 615 02XX Ups (French) Socket (Earthed)		2220 616 02XX Ups (French) Soc.Child Prot.		2220 617 02XX Ups (French) Soc. With Cover		2220 618 02XX Ups (French) Soc.W.Cover (C.P.)	2220 448 01XX 1*Usb Charger	2220 449 01XX 2*Usb Charger
2220 200 02XX Double Socket Earthed Porcelain	2220 201 02XX Double Soc.Non Earthed Porcelain	2220 202 02XX Double Socket Earthed	2220 203 02XX Double Soc.Non Earthed	2220 215 01XX Double Socket Ups		2220 619 02XX 2*Usb (2,4A) Earthed Socket						
COMMUNICATION GROUP												
	2220 125 01XX Phonesocket 1* Rj12 (Cat3)	2220 126 01XX Telephone Soc.2xRj12	2220 128 01XX Tlf Data Soc.W/O Con. Label	2220 135 02XX Data Soc.1* Rj45w/Ocon.		2220 136 01XX Data Soc.1* Rj45 (Cat5e)		2220 137 01XX Data Soc.2* Rj45w/Ocon.		2220 138 01XX Data Soc.2* Rj45 (Cat5e)	2220 139 01XX Tlf Data Soc.(Rj12 Cat5e)	
	2220 140 01XX Data Soc.1* Rj45 (Cat6)	2220 141 01XX Data Soc.2* Rj45 (Cat6)	2220 455 01XX Data Soc.1* Usb	2220 456 01XX Data Soc.2* Usb	2220 457 01XX Data Soc.1* Hdmi	2220 458 01XX Data Soc.2* Hdmi		2220 459 01XX Data Soc. 1*Usb/1*Hdmi	2220 460 01XX Switch Vga Socket			
		TV / SAT GROUP										
	2220 121 02XX Blind Cover White		2220 156 02XX Tv-Sat Soc.Thr.4db/Fcon.	2220 157 02XX Tv-Sat Soc.(Dead End)	2220 166 01XX Sat Soc.(Through)4db/Fcon.	2220 167 01XX Sat Soc.(Dead End)	2220 170 01XX Tv Socket (Thr) 11db	2220 171 01XX Tv Soc.(Dead End) 11db	2220 172 01XX Tv Socket F Female			



NATURAL



01 - WHITE



02 - CREAM

WOOD



56 - CHERRY



57 - WALNUTS



58 - OAK

METALLIC



80 - GOLD



82 - INOX



83 - TITANIUM



85 - DORE



84 - BLACK



95 - SMOKE

PASTEL



04 - RED



06 - ORANGE



08 - YELLOW



10 - GREEN



11 - PINK



12 - BLUE



25 - PURPLE



09 - NAVY BLUE



03 - GREY

Code	Product Description	Number of Box	Quantity of Package
------	---------------------	---------------	---------------------

Switch Group (With Screw)

2200 401 02XX	One Gang One Way Switch	12	120
2200 402 02XX	Two Gang One Way Control	12	120
2200 403 02XX	One Gang Two Way Switch	12	120
2200 404 02XX	Two Gang Two Way Switch	12	120
2200 405 02XX	One Gang One Way Dp	12	120
2200 406 02XX	Blind Switch -W/Spring	12	120
2200 436 02XX	Jalousie Switch with screw without spring	12	120
2200 407 02XX	One Gang One Way Control	12	120
2200 407 02XXK	Door Switch	12	120
2200 407 02XXZ	Ring Switch	12	120
2200 408 02XX	One Gang Intermediate-Deviator	12	120
2200 409 02XX	3 Gang Switch	12	120
2200 411 02XX	Heater Switch	12	120
2200 415 02XX	Illu.1g.1w.Swi. (220v)	12	120
2200 416 02XX	Illu.One Gang Two Way (220v)	12	120
2200 417 02XX	Illu.1g.1w.Cntrl (220v)	12	120
2200 418 02XX	Illu.1g.1w.W/Lab. (220v)	12	120
2200 419 02XX	I.1g.1w.Ctrlw/Lab. (220v)	12	120
2200 422 02XX	Illu.1g.1w.Cntrl (12v)	12	120
2200 426 02XX	Illu.Two Gang One Way Switch	12	120

Switch Group (Easy Connection)

2200 401 01XX	One Gang One Way Switch	12	120
2200 402 01XX	Two Gang One Way Control	12	120
2200 403 01XX	One Gang Two Way Switch	12	120
2200 404 01XX	Two Gang Two Way Switch	12	120
2200 405 01XX	One Gang One Way Dp	12	120
2200 406 01XX	Blind Switch -W/Spring	12	120
2200 436 01XX	Jalousie Switch , easy connection without spring	12	120
2200 407 01XX	One Gang One Way Control	12	120
2200 407 01XXK	Door Switch	12	120
2200 407 01XXZ	Ring Switch	12	120
2200 408 01XX	One Gang Intermediate-Deviator	12	120
2200 409 01XX	3 Gang Switch	12	120
2200 415 01XX	Illu.1g.1w.Swi. (220v)	12	120
2200 416 01XX	Illu.One Gang Two Way (220v)	12	120
2200 417 01XX	Illu.1g.1w.Cntrl (220v)	12	120
2200 418 01XX	Illu.1g.1w.W/Lab. (220v)	12	120
2200 419 01XX	I.1g.1w.Ctrlw/Lab. (220v)	12	120
2200 422 01XX	Illu.1g.1w.Cntrl (12v)	12	120
2200 426 01XX	Illu.Two Gang One Way Switch	12	120

Dimmer Group

2200 440 02XX	Rotary Dimmer 600W	8	80
2200 443 02XX	Rotary Dimmer (CE) 600W		
2200 444 02XX	Rotary Dimmer 1000W	8	80
2200 447 02XX	RC Dimmer	8	80

Electronics Group

2200 450 01XX	Energy Saver Not Delay Illu.	8	80
2200 452 01XX	Energy Saver Delay Illu.	8	80
2200 470 02XX	Audio Switch	8	80
2200 480 01XX	Speaker Socket	8	80
2200 485 02XX	Warning Bell	8	80
2200 495 02XX	Motion Sensor	8	80

Socket Group

2200 600 02XX	Earthed Socket	12	120
2200 601 02XX	Non Earthed Socket	12	120
2200 605 02XX	Earthed Socket (Child Protection)	12	120
2200 606 02XX	Non Earthed Socket -Child Protection	12	120
2200 610 02XX	Earthed Socket With Cover	12	120
2200 611 02XX	Earthed Socket Cover (Child Protection)	12	120
2200 615 02XX	Ups (French) Socket (Earthed)	12	120
2200 616 02XX	Ups (French) Socket Child Protection	12	120
2200 617 02XX	Ups (French) Soc. With Cover	12	120
2200 618 02XX	Ups (French) Soc.With Cover Child Pro	12	120
2220 200 02XX	Double Socket Earthed Porcelain	5	50
2220 201 02XX	Double Soc.Non Earthed Porcelain	5	50
2220 202 02XX	Double Socket Earthed	5	50
2220 203 02XX	Double Soc.Non Earthed	5	50
2220 215 02XX	Double Socket Ups	5	50
2200 448 01XX	Single USB charging socket	5	50
2200 449 01XX	Double usb charging socket	5	50
2200 619 02XX	2*Usb (2,4A) earthed socket (child prot.)	8	-



It can be used with single frame only.



- Gold 80
- Inox 82
- Titanium 83
- Black 84
- Smoked 95





Code	Product Description	Number of Box	Quantity of Package
------	---------------------	---------------	---------------------

Communication Group

2200 125 01XX	Phonesocket 1*Rj12 (Cat3)	12	120
2200 126 01XX	Telephone Soc.2xRJ12	12	120
2200 128 01XX	Tlf Data Soc.W/O Con. Label	12	120
2200 135 01XX	Data Soc.1*Rj45w/Ocon.	12	120
2200 136 01XX	Data Soc.1*Rj45 (Cat5e)	12	120
2200 137 01XX	Data Soc.2*Rj45w/Ocon.	12	120
2200 138 01XX	Data Soc.2*Rj45 (Cat5e)	12	120
2200 139 01XX	Tlf Data Soc.(Rj12 Cat5e)	12	120
2200 140 01XX	Data Soc.1*Rj45 (Cat6)	12	120
2200 141 01XX	Data Soc.2*Rj45 (Cat6)	12	120
2200 455 01XX	Data Soc.1*Usb	12	120
2200 456 01XX	Data Soc.2*Usb	12	120
2200 457 01XX	Data Soc.1*Hdmi	12	120
2200 458 01XX	Data Soc.2*Hdmi	12	120
2200 459 01XX	Data Soc. 1*Usb/1*Hdmi	12	120
2200 460 01XX	Switch Vga Socket	12	120
NEW 2200 461 01XX	Switch +mechanism , 2 outlets, fiber optic socket	12	120
2200 121 02XX	Blind Cover White	12	120

Tv - Sat Group

2200 156 02XX	Tv-Sat Soc.Thr.4db/Fcon.	12	120
2200 157 02XX	Tv-Sat Soc.(Dead End)	12	120
2200 166 01XX	Sat Soc.(Through)4db/Fcon.	12	120
2200 167 01XX	Sat Soc.(Dead End)	12	120
2200 170 01XX	Tv Socket (Thr) 11db	12	120
2200 171 01XX	Tv Soc.(Dead End) 11db	12	120
2200 172 01XX	Tv Socket F Female	12	120
2200 173 01XX	Tv Socket Male (Through)	12	120
2200 174 01XX	Tv Socket Male (Dead End)	12	120

Frame

2220 800 11XX	One Gang Frame	20	400
2220 800 12XX	2g. Horizontal Frame	10	200
2220 800 13XX	3g. Horizontal Frame	10	50
2220 800 14XX	4g. Horizontal Frame	10	50
2220 800 15XX	5g. Horizontal Frame	10	50
2220 800 16XX	6g. Horizontal Frame	10	50
2220 800 22XX	2g. Vertical Frame	10	50
2220 800 23XX	3g. Vertical Frame	10	50
2220 800 24XX	4g. Vertical Frame	10	50
2220 800 25XX	5g. Vertical Frame	10	50
2220 800 26XX	6g. Vertical Frame	10	50
2220 820 12XX	Double Socket Frame	12	60
2100 000 11XX	Surface Mounted Case	12	60
NEW 2200 000 11XX	Surpafe M Case	-	-
2200 800 00XX	Phone holder	24	240
NEW 2200 000 00XX	Flush mounted earthed and covered socket protection gasket	24	120

RITA PASTEL Frame

2220 800 11XX	One Gang Frame	20	400
2220 800 12XX	2g. Horizontal Frame	10	200
2220 800 13XX	3g. Horizontal Frame	10	50
2220 800 14XX	4g. Horizontal Frame	10	50
2220 800 15XX	5g. Horizontal Frame	10	50
2220 800 16XX	6g. Horizontal Frame	10	50
2220 800 22XX	2g. Vertical Frame	10	50
2220 800 23XX	3g. Vertical Frame	10	50
2220 800 24XX	4g. Vertical Frame	10	50
2220 800 25XX	5g. Vertical Frame	10	50
2220 800 26XX	6g. Vertical Frame	10	50

New
YENİ



Yeni
Swa Üstü Kasa
Uygulamas ile istediğiniz Kadar
Anahtar Uygulaması
Yapabilirsiniz.



Elitra | Plus

Challenge ordinaryness...



Elitra | Plus

Elitra Glass



XXX-811



XXX-814



► WHITE / BLACK

Code	Product Description	Number of Box
2170 XXX 11XX	One Gang Frame	10
2170 XXX 12XX	2g. Horizontal Frame	10
2170 XXX 13XX	3g. Horizontal Frame	10
2170 XXX 14XX	4g. Horizontal Frame	10
2170 XXX 15XX	5g. Horizontal Frame	10
2170 XXX 22XX	2g. Vertical Frame	10
2170 XXX 23XX	3g. Vertical Frame	10
2170 XXX 24XX	4g. Vertical Frame	10
2170 XXX 25XX	5g. Vertical Frame	10

Elitra Chrome



XXX-821



XXX-824

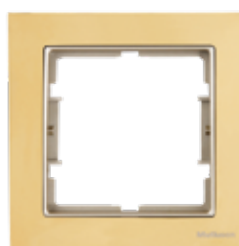

XXX-822

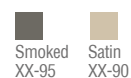

► CHROME / STAINLESS STEEL / GOLD

Code	Product Description	Number of Box
2170 XXX 11XX	One Gang Frame	10
2170 XXX 12XX	2g. Horizontal Frame	10
2170 XXX 13XX	3g. Horizontal Frame	10
2170 XXX 14XX	4g. Horizontal Frame	10
2170 XXX 15XX	5g. Horizontal Frame	10
2170 XXX 16XX	6g. Horizontal Frame	10
2170 XXX 22XX	2g. Vertical Frame	10
2170 XXX 23XX	3g. Vertical Frame	10
2170 XXX 24XX	4g. Vertical Frame	10
2170 XXX 25XX	5g. Vertical Frame	10
2170 XXX 26XX	6g. Vertical Frame	10



XXX-825



XXX-825

Smoked
XX-95

Silver
XX-92

► **SILVER / GLOSSY SMOKE**

Code	Product Description	Number of Box
2170 825 11XX	One Gang Frame	10
2170 825 12XX	2g. Horizontal Frame	10
2170 825 13XX	3g. Horizontal Frame	10
2170 825 14XX	4g. Horizontal Frame	10
2170 825 15XX	5g. Horizontal Frame	10
2170 825 16XX	6g. Horizontal Frame	10
2170 825 22XX	2g. Vertical Frame	10
2170 825 23XX	3g. Vertical Frame	10
2170 825 24XX	4g. Vertical Frame	10
2170 825 25XX	5g. Vertical Frame	10
2170 825 26XX	6g. Vertical Frame	10



XXX-827



XXX-828

Smoked
XX-95

Satin
XX-90

► **MATTE ALUMINUM / MATTE SATIN**

Code	Product Description	Number of Box
2170 XXX 11XX	One Gang Frame	10
2170 XXX 12XX	2g. Horizontal Frame	10
2170 XXX 13XX	3g. Horizontal Frame	10
2170 XXX 14XX	4g. Horizontal Frame	10
2170 XXX 15XX	5g. Horizontal Frame	10
2170 XXX 16XX	6g. Horizontal Frame	10
2170 XXX 22XX	2g. Vertical Frame	10
2170 XXX 23XX	3g. Vertical Frame	10
2170 XXX 24XX	4g. Vertical Frame	10
2170 XXX 25XX	5g. Vertical Frame	10
2170 XXX 26XX	6g. Vertical Frame	10

Elitra Plus

Elitra Wood

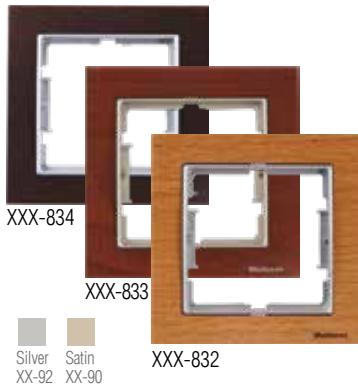

► BEECH / CHERRY / VENGE

Code	Product Description	Number of Box
2170 XXX 11XX	One Gang Frame	10
2170 XXX 12XX	2g. Horizontal Frame	10
2170 XXX 13XX	3g. Horizontal Frame	10
2170 XXX 14XX	4g. Horizontal Frame	10
2170 XXX 15XX	5g. Horizontal Frame	10
2170 XXX 22XX	2g. Vertical Frame	10
2170 XXX 23XX	3g. Vertical Frame	10
2170 XXX 24XX	4g. Vertical Frame	10
2170 XXX 25XX	5g. Vertical Frame	10

Elitra Marble

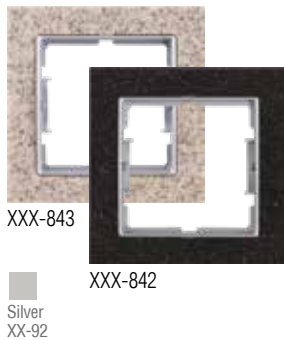

► BLACK QUARTZ / SAND STONE

Code	Product Description	Number of Box
2170 XXX 11XX	One Gang Frame	10
2170 XXX 12XX	2g. Horizontal Frame	10
2170 XXX 13XX	3g. Horizontal Frame	10
2170 XXX 14XX	4g. Horizontal Frame	10
2170 XXX 15XX	5g. Horizontal Frame	10
2170 XXX 22XX	2g. Vertical Frame	10
2170 XXX 23XX	3g. Vertical Frame	10
2170 XXX 24XX	4g. Vertical Frame	10
2170 XXX 25XX	5g. Vertical Frame	10

Elitra Ale



► NATURAL / SATEN / MATTE SMOKED

Code	Product Description	Number of Box
2170 XXX 11XX	One Gang Frame	10
2170 XXX 12XX	2g. Horizontal Frame	10
2170 XXX 13XX	3g. Horizontal Frame	10
2170 XXX 14XX	4g. Horizontal Frame	10
2170 XXX 15XX	5g. Horizontal Frame	10
2170 XXX 16XX	6g. Horizontal Frame	10
2170 XXX 22XX	2g. Vertical Frame	10
2170 XXX 23XX	3g. Vertical Frame	10
2170 XXX 24XX	4g. Vertical Frame	10
2170 XXX 25XX	5g. Vertical Frame	10
2170 XXX 26XX	6g. Vertical Frame	10



White
 Satin
 Silver
 Smoked
 XX-01 XX-90 XX-92 XX-95

Code	Product Description	Number of Box
Switch Group (With Screw)		
2270 401 02XX	One Gang One Way Switch	10
2270 402 02XX	Two Gang One Way Control	10
2270 403 02XX	One Gang Two Way Switch	10
2270 404 02XX	Two Gang Two Way Switch	10
2270 405 02XX	One Gang One Way Dp	10
2270 406 02XX	Blind Switch -W/Spring	10
2270 407 02XX	One Gang One Way Control	10
2270 407 02XXZ	Ring Switch	10
2270 407 02XXK	Door Switch	10
2270 408 02XX	One Gang Intermediate-Deviator	10
2270 409 02XX	3 Gang Switch	10
2270 411 02XX	Heater Switch	10
2270 415 02XX	llu.1g.1w.Swi. (220v)	10
2270 416 02XX	llu.One Gang Two Way (220v)	10
2270 417 02XX	llu.1g.1w.Cntrl (220v)	10
2270 418 02XX	llu.1g.1w.W/Lab. (220v)	10
2270 419 02XX	l.1g.1w.Ctrlw/Lab. (220v)	10
2270 422 02XX	llu.1g.1w.Cntrl (12v)	10
2270 426 02XX	llu.Two Gang One Way Switch	10
Switch Group (Easy Connection)		
2270 401 01XX	One Gang One Way Switch	10
2270 402 01XX	Two Gang One Way Control	10
2270 403 01XX	One Gang Two Way Switch	10
2270 404 01XX	Two Gang Two Way Switch	10
2270 405 01XX	One Gang One Way Dp	10
2270 406 01XX	Blind Switch -W/Spring	10
2270 407 01XX	One Gang One Way Control	10
2270 407 01XXZ	Ring Switch	10
2270 407 01XXK	Door Switch	10
2270 408 01XX	One Gang Intermediate-Deviator	10
2270 409 01XX	3 Gang Switch	10
2270 415 01XX	llu.1g.1w.Swi. (220v)	10
2270 416 01XX	llu.One Gang Two Way (220v)	10
2270 417 01XX	llu.1g.1w.Cntrl (220v)	10
2270 418 01XX	llu.1g.1w.W/Lab. (220v)	10
2270 419 01XX	l.1g.1w.Ctrlw/Lab. (220v)	10
2270 422 01XX	llu.1g.1w.Cntrl (12v)	10
2270 426 01XX	llu.Two Gang One Way Switch	10
Dimmer Group		
2270 440 02XX	RL Rotary Dimmer 600W	8
2270 444 02XX	RL Rotary Dimmer 1000W	8
2270 447 02XX	RC Dimmer 325W	8
Electronics Group		
2270 050 01XX	Energy Saver Without Delay Illu.	8
2270 052 01XX	Energy Saver Delay Illu.	8
2270 070 02XX	Audio Switch	8
2270 080 01XX	Speaker Socket	10
2270 085 02XX	Warning Bell	10
2270 095 02XX	Motion Sensor	10
Socket Group		
2270 600 02XX	Earthed Socket	10
2270 601 02XX	Non Earthed Socket	10
2270 605 02XX	Earthed Socket (Child Protection)	10
2270 606 02XX	Non Earthed Socket -Child Protection	10
2270 610 02XX	Earthed Socket With Cover	10
2270 611 02XX	Earthed Socket Cover (Child Protection)	10
2270 615 02XX	Ups (French) Socket (Earthed)	10
2270 616 02XX	Ups (French) Socket Child Protection	10
2270 617 02XX	Ups (French) Soc. With Cover	10
2270 618 02XX	Ups (French) Soc.With Cover Child Pro	10
2270 121 02XX	Blind Cover White	10
Communication Group		
2270 455 01XX	Data Soc.1*Usb	10
2270 456 01XX	Data Soc.2*Usb	10
2270 457 01XX	Data Soc.1*Hdmi	10
2270 458 01XX	Data Soc.2*Hdmi	10
2270 459 01XX	Data Soc. 1*Usb/1*Hdmi	10
2270 125 01XX	Phonesocket 1*Rj12 (Cat3)	10
2270 126 01XX	Telephone Soc.2xrj12	10
2270 128 01XX	Tlf Data Soc.W/O Con. Label	10
2270 135 01XX	Data Soc.1*Rj45w/Ocon.	10
2270 136 01XX	Data Soc.1*Rj45 (Cat5e)	10
2270 137 01XX	Data Soc.2*Rj45w/Ocon.	10
2270 138 01XX	Data Soc.2*Rj45 (Cat5e)	10
2270 139 01XX	Tlf Data Soc.(Rj12 Cat5e)	10
2270 140 01XX	Data Soc.1*Rj45 (Cat6)	10
2270 141 01XX	Data Soc.2*Rj45 (Cat6)	10
Tv - Sat Group		
2270 156 02XX	Tv-Sat Soc.Thr.4db/Fcon.	10
2270 157 02XX	Tv-Sat Soc.(Dead End)	10
2270 166 01XX	Sat Soc.(Through)4db/Fcon.	10
2270 167 01XX	Sat Soc.(Dead End)	10
2270 170 01XX	Tv Socket (Thr)	10
2270 171 01XX	Tv Soc.(Dead End)	10
2270 172 01XX	Tv Socket F Female	10

Candelä

For Stylish Solutions ...



SWITCH GROUP (WITH SCREW)													
	2125 401 00XX Oneg. One Way Switch	2125 402 02XX TwoG. One Way Control	2125 403 02XX Oneg. Two Way Switch	2125 404 02XX Two Gang Two Way Switch	2125 405 02XX Oneg. One Way Dp	2125 406 02XX Blind Switch -W/Spring	2125 407 02XX One Gang One Way Cont.	2125 407 02XXK Door Switch					
	2125 407 02XXZ Ring Switch	2125 408 02XX Oneg. Intermediate-Deviator	2125 409 02XX 3 Gang Switch	2125 411 02XX Heater Switch	2125 415 02XX Illu.1g.1w.Swi. (220v)	2125 416 02XX Illu.Oneg. Two Way (220v)	2125 417 02XX Illu.1g.1w.Cntrl (220v)	2125 418 02XX Illu.1g.1w.W/Lab. (220v)	2125 419 02XX I.1g.1w.Cntrlw/Lab. (220v)				
			SWITCH GROUP (EASY CONNEC.)										
	2125 422 02XX Illu.1g.1w.Cntrl (12v)	2125 426 02XX Illu.TwoG. One Way Switch		2125 401 01XX Oneg. One Way Switch	2125 402 01XX TwoG. One Way Control	2125 403 01XX Oneg. Two Way Switch	2125 404 01XX Two Gang Two Way Switch	2125 405 01XX Oneg. One Way Dp	2125 406 01XX Blind Switch -W/Spring				
	2125 407 01XX One Gang One Way Control	2125 407 01XXK Door Switch		2125 407 01XXZ Ring Switch	2125 408 01XX Oneg. Intermediate-Deviator	2125 409 01XX 3 Gang Switch	2125 415 01XX Illu.1g.1w.Swi. (220v)	2125 416 01XX Illu.Oneg. Two Way (220v)	2125 417 01XX Illu.1g.1w.Cntrl (220v)	2125 418 01XX Illu.1g.1w.W/Lab. (220v)			
					DIMMER GROUP				ELECTRONICS GROUP				
	2125 419 01XX I.1g.1w.Cntrlw/Lab. (220v)	2125 422 01XX Illu.1g.1w.Cntrl (12v)		2125 426 01XX Illu.TwoG. One Way Switch		2125 440 02XX Rotary Dimmer 600W	2125 444 02XX Rotary Dimmer 1000W	2125 447 02XX RC Dimmer 325W		2125 450 01XX Energy Saver Not Delay Illu.			
							SOCKET GROUP						
2125 452 01XX Energy Saver Delay Illu.	2125 470 02XX Audio Switch	2125 480 01XX Speaker Socket		2125 485 02XX Warning Bell		2125 495 02XX Motion Sensor		2125 600 02XX Earthed Socket		2125 601 02XX Non Earthed Socket	2125 605 02XX Earthed Socket (Child Prot.)		
2125 606 02XX Non Earthed Soc.-Child Prot.	2125 610 02XX Earthed Socket With Cover	2125 611 02XX Earthed Soc.Cover (Ch. Prot.)		2125 615 02XX Ups (French) Soc. (Earthed)		2125 616 02XX Ups (French) Soc. Child Prot.		2125 617 02XX Ups (French) Soc. With Cover		2125 618 02XX Ups (French) Soc.W.Cover (C.P.)	2125 448 01XX 1*Usb Charger	2125 449 01XX 2*Usb Charger	
						COMMUNICATION GROUP							
2125 200 02XX Double Socket Earthed Porcelain	2125 201 02XX Double Soc.Non Earthed Porcelain	2125 202 02XX Double Socket Earthed	2125 203 02XX Double Soc.Non Earthed	2125 215 01XX Double Socket Ups									
2125 125 01XX Phonesocket 1*Rj12 (Cat3)	2125 126 01XX Telephone Soc.2xrj12	2125 128 01XX Tlf Data Soc.W/O Con. Label	2125 135 02XX Data Soc.1*Rj45w/Ocon.	2125 136 01XX Data Soc.1*Rj45 (Cat5e)						2125 137 01XX Data Soc.2*Rj45w/Ocon.	2125 138 01XX Data Soc.2*Rj45 (Cat5e)	2125 139 01XX Tlf Data Soc.(Rj12 Cat5e)	
2125 140 01XX Data Soc.1*Rj45 (Cat6)	2125 141 01XX Data Soc.2*Rj45 (Cat6)	2125 455 01XX Data Soc.1*Usb	2125 456 01XX Data Soc.2*Usb	2125 457 01XX Data Soc.1*Hdmi	2125 458 01XX Data Soc.2*Hdmi				2125 459 01XX Data Soc.1*Usb/1*Hdmi	2125 460 01XX Switch Vga Socket	2125 121 02XX Blind Cover White		
										TV / SAT GROUP			
2125 156 02XX Tv-Sat Soc.Thr.4db/Fcon.	2125 157 02XX Tv-Sat Soc.(Dead End)	2125 166 01XX Sat Soc.(Through)4db/Fcon.	2125 167 01XX Sat Soc.(Dead End)	2125 170 01XX Tv Socket (Thr) 11db	2125 171 01XX Tv Soc.(Dead End) 11db				2125 172 01XX Tv Socket F Female				

NATURAL



01 - WHITE



02 - CREAM

WOOD



56 - CHERRY



57 - WALNUTS



58 - OAK

METALLIC



80 - GOLD



82 - INOX



83 - TITANIUM



85 - DORE



84 - BLACK



95 - SMOKE



Candela

Mechanism + Plate Product List

Code	Product Description	Number of Box	Quantity of Package
Switch Group (With Screw)			
2100 401 02XX	One Gang One Way Switch	12	120
2100 402 02XX	Two Gang One Way Control	12	120
2100 403 02XX	One Gang Two Way Switch	12	120
2100 404 02XX	Two Gang Two Way Switch	12	120
2100 405 02XX	One Gang One Way Dp	12	120
2100 406 02XX	Blind Switch -W/Spring	12	120
2100 436 02XX	Jalousie Switch, easy connection, without spring	12	120
2100 407 02XX	One Gang One Way Control	12	120
2100 407 02XXK	Door Switch	12	120
2100 407 02XXZ	Ring Switch	12	120
2100 408 02XX	One Gang Intermediate-Deviator	12	120
2100 409 02XX	3 Gang Switch	12	120
2100 411 02XX	Heater Switch	12	120
2100 415 02XX	Illu.1g.1w.Swi. (220v)	12	120
2100 416 02XX	Illu.One Gang Two Way (220v)	12	120
2100 417 02XX	Illu.1g.1w.Cntrl (220v)	12	120
2100 418 02XX	Illu.1g.1w.W/Lab. (220v)	12	120
2100 419 02XX	I.1g.1w.Ctrl W/Lab. (220v)	12	120
2100 422 02XX	Illu.1g.1w.Cntrl (12v)	12	120
2100 426 02XX	Illu.Two Gang One Way Switch	12	120
Switch Group (Easy Connection)			
2100 401 01XX	One Gang One Way Switch	12	120
2100 402 01XX	Two Gang One Way Control	12	120
2100 403 01XX	One Gang Two Way Switch	12	120
2100 404 01XX	Two Gang Two Way Switch	12	120
2100 405 01XX	One Gang One Way Dp	12	120
2100 406 01XX	Blind Switch -W/Spring	12	120
2100 436 01XX	Jalousie Switch , easy connection without spring	12	120
2100 407 01XX	One Gang One Way Control	12	120
2100 407 01XXK	Door Switch	12	120
2100 407 01XXZ	Ring Switch	12	120
2100 408 01XX	One Gang Intermediate-Deviator	12	120
2100 409 01XX	3 Gang Switch	12	120
2100 415 01XX	Illu.1g.1w.Swi. (220v)	12	120
2100 416 01XX	Illu.One Gang Two Way (220v)	12	120
2100 417 01XX	Illu.1g.1w.Cntrl (220v)	12	120
2100 418 01XX	Illu.1g.1w.W/Lab. (220v)	12	120
2100 419 01XX	I.1g.1w.Ctrl W/Lab. (220v)	12	120
2100 422 01XX	Illu.1g.1w.Cntrl (12v)	12	120
2100 426 01XX	Illu.Two Gang One Way Switch	12	120
Dimmer Group			
2100 440 02XX	RL Rotary Dimmer 600W	8	80
2200 443 02XX	RL Rotary Dimmer (CE) 600W	8	80
2100 444 02XX	RL Rotary Dimmer 1000W	8	80
2100 447 02XX	RC Dimmer 325W	8	80
Electronics Group			
2100 450 01XX	Energy Saver Not Delay Illu.	8	80
2100 452 01XX	Energy Saver Delay Illu.	8	80
2100 470 02XX	Audio Switch	8	80
2100 480 01XX	Speaker Socket	8	80
2100 485 02XX	Warning Bell	8	80
2100 495 02XX	Motion Sensor	8	80
Socket Group			
2100 600 02XX	Earthed Socket	12	120
2100 601 02XX	Non Earthed Socket	12	120
2100 605 02XX	Earthed Socket (Child Protection)	12	120
2100 606 02XX	Non Earthed Socket -Child Protection	12	120
2100 610 02XX	Earthed Socket With Cover	12	120
2100 611 02XX	Earthed Socket Cover (Child Protection)	12	120
2100 615 02XX	Ups (French) Socket (Earthed)	12	120
2100 616 02XX	Ups (French) Socket Child Protection	12	120
2100 617 02XX	Ups (French) Soc. With Cover	12	120
2100 618 02XX	Ups (French) Soc.With Cover Child Pro	12	120
2125 200 02XX	Double Socket Earthed Porcelain	5	50
2125 201 02XX	Double Soc.Non Earthed Porcelain	5	50
2125 202 02XX	Double Socket Earthed	5	50
2125 203 02XX	Double Soc.Non Earthed	5	50
2125 215 02XX	Double Socket Ups	5	50
2100 448 01XX	Single USB charging socket	5	50
2100 449 01XX	Double usb charging socket	5	50



Candela

Mechanism + Plate Product List

Code	Product Description	Number of Box	Quantity of Package
------	---------------------	---------------	---------------------

Communication Group

2100 125 01XX	Phonesocket 1*Rj12 (Cat3)	12	120
2100 126 01XX	Telephone Soc.2xRJ12	12	120
2100 128 01XX	Tlf Data Soc.W/O Con. Label	12	120
2100 135 01XX	Data Soc.1*Rj45w/Ocon.	12	120
2100 136 01XX	Data Soc.1*Rj45 (Cat5e)	12	120
2100 137 01XX	Data Soc.2*Rj45w/Ocon.	12	120
2100 138 01XX	Data Soc.2*Rj45 (Cat5e)	12	120
2100 139 01XX	Tlf Data Soc.(Rj12 Cat5e)	12	120
2100 140 01XX	Data Soc.1*Rj45 (Cat6)	12	120
2100 141 01XX	Data Soc.2*Rj45 (Cat6)	12	120
2100 455 01XX	Data Soc.1*Usb	12	120
2100 456 01XX	Data Soc.2*Usb	12	120
2100 457 01XX	Data Soc.1*Hdmi	12	120
2100 458 01XX	Data Soc.2*Hdmi	12	120
2100 459 01XX	Data Soc. 1*Usb/1*Hdmi	12	120
2100 460 01XX	Switch Vga Socket	12	120
2100 121 02XX	Blind Cover White	12	120



Tv - Sat Group

2100 156 02XX	Tv-Sat Soc.Thr.4db/Fcon.	12	120
2100 157 02XX	Tv-Sat Soc.(Dead End)	12	120
2100 166 01XX	Sat Soc.(Through)4db/Fcon.	12	120
2100 167 01XX	Sat Soc.(Dead End)	12	120
2100 170 01XX	Tv Socket (Thr) 11db	12	120
2100 171 01XX	Tv Soc.(Dead End) 11db	12	120
2100 172 01XX	Tv Socket F Female	12	120
2100 173 01XX	Tv Socket Male (Through)	12	120
2100 174 01XX	Tv Socket Male (Dead End)	12	120



Frame

2125 800 11XX	One Gang Frame	20	400
2125 800 12XX	2g. Horizontal Frame	10	200
2125 800 13XX	3g. Horizontal Frame	10	50
2125 800 14XX	4g. Horizontal Frame	10	50
2125 800 15XX	5g. Horizontal Frame	10	50
2125 800 16XX	6g. Horizontal Frame	10	50
2125 800 22XX	2g. Vertical Frame	10	50
2125 800 23XX	3g. Vertical Frame	10	50
2125 800 24XX	4g. Vertical Frame	10	50
2125 800 25XX	5g. Vertical Frame	10	50
2125 800 26XX	6g. Vertical Frame	10	50
2125 820 12XX	Double Socket Frame	12	60
2100 000 11XX	Surface Mounted Case	12	60
 2200 000 00XX	Flush mounted earthed and covered socket protection gasket	24	120



OLIMPIA PI-TECH
NEMLIYER
BRON
DARIA
CANDELA
PLUS
RITA



► RITA MODULAR SYSTEM

Code	Description	Piece	Price
2200 250 01XX	Speakhone Socket	1	ASK THE CUSTOMER REPRESENTATIVE PRICE.
2200 251 01XX	RCA Socket	1	
2200 252 01XX	3,5 Audio Jack Socket	1	
2200 253 01XX	XLR Male Socket	1	
2200 254 01XX	XLR Female Socket	1	
2200 255 01XX	Usb Printer Socket	1	



► ELECTRONIC PRICES

Code	Description	Piece	Price
2100 852 0000	30a+16a Energy Saver Relay Pcb (Vrf/Fc)	1	ASK THE CUSTOMER REPRESENTATIVE PRICE.
2100 853 0000	3x16a Energy Saver Relay Pcb (Vrf/Fc)	1	
2100 854 0000	3x16a Energy Saver - Dnd Relay Pcb (Vrf/Fc)	1	
2100 855 0000	30a+2x16a Energy Saver - Dnd Relay Pcb (Vrf/Fc)	1	
2110 052 0001	Energy Saver Cover	1	
2100 012 01XX	Mec. + Switch Impuls Switch	12	
2100 023 01XX	Mec. + Switch Impuls Commutator	12	
2100 024 01XX	Mec. + Switch Impuls Illuminated Switch (220v)	12	
2100 027 01XX	Mec. + Switch Impuls Illuminated Commutator	12	
2125 010 0101	Hotel Warning Indoor Unit Commutator (Mechanical) Light	12	
2220 010 0101	Hotel Warning Indoor Unit Commutator (Mechanical) Light	12	
2220 010 0201	Hotel Warning Indoor Unit Commutator (Mec.) Light Screw	12	
2200 412 01XX	Impulse Key (Easy Connection)	12	
2200 412 02XX	Impulse Wrench (Screw)	12	
2200 423 01XX	Impulse Commutator (Easy Connection)	12	
2200 423 02XX	Impulse Commutator (Screw)	12	
2200 424 01XX	Impulse Light Switch (Easy Connection)	12	
2200 424 02XX	Impulse Illuminated Switch (Screw)	12	
2200 427 01XX	Impulse Illuminated Commutator (Easy Connection)	12	
2200 427 02XX	Impulse Illuminated Commutator (Screw)	12	

Dariä

For Stylish Solutions ...



SWITCH GROUP (WITH SCREW)



2120 401 00XX
One-g. One Way Switch



2120 402 02XX
Two-g. One Way Control



2120 403 02XX
One-g. Two Way Switch



2120 404 02XX
Two-gang Two Way Switch



2120 405 02XX
One-g. One Way Dip



2120 406 02XX
Blind Switch -W/Spring



2120 407 02XX
One-gang One Way Cont.



2120 407 02XXK
Door Switch



2120 407 02XXZ
Ring Switch



2120 408 02XX
One-g. Intermediate-Deviator



2120 409 02XX
3-gang Switch



2120 411 02XX
Heater Switch



2120 415 02XX
Illu. 1-g. 1-w. Swi. (220v)



2120 416 02XX
Illu. One-g. Two Way (220v)



2120 417 02XX
Illu. 1-g. 1-w. Cntrl (220v)



2120 418 02XX
Illu. 1-g. 1-w. W/Lab. (220v)



2120 419 02XX
I. 1-g. 1-w. Cntrl/Lab. (220v)



2120 422 02XX
Illu. 1-g. 1-w. Cntrl (12v)



2120 426 02XX
Illu. Two-g. One Way Switch

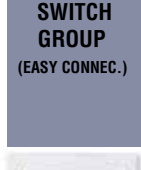

**SWITCH GROUP
(EASY CONNEX.)**



2120 401 01XX
One-g. One Way Switch



2120 402 01XX
Two-g. One Way Control



2120 403 01XX
One-g. Two Way Switch



2120 404 01XX
Two-gang Two Way Switch



2120 405 01XX
One-g. One Way Dip



2120 406 01XX
Blind Switch -W/Spring



2120 407 01XX
One-gang One Way Control



2120 407 01XXK
Door Switch



2120 407 01XXZ
Ring Switch



2120 408 01XX
One-g. Intermediate-Deviator



2120 409 01XX
3-gang Switch



2120 415 01XX
Illu. 1-g. 1-w. Swi. (220v)



2120 416 01XX
Illu. One-g. Two Way (220v)



2120 417 01XX
Illu. 1-g. 1-w. Cntrl (220v)



2120 418 01XX
Illu. 1-g. 1-w. W/Lab. (220v)



2120 419 01XX
I. 1-g. 1-w. Cntrl/Lab. (220v)



2120 422 01XX
Illu. 1-g. 1-w. Cntrl (12v)



2120 426 01XX
Illu. Two-g. One Way Switch



DIMMER GROUP



2120 440 02XX
Rotary Dimmer 600W



2120 444 02XX
Rotary Dimmer 1000W



2120 447 02XX
RC Dimmer 325W



ELECTRONICS GROUP



2120 450 01XX
Energy Saver Not Delay Illu.



2120 452 01XX
Energy Saver Delay Illu.



2120 470 02XX
Audio Switch



2120 480 01XX
Speaker Socket



2120 485 02XX
Warning Bell



2120 495 02XX
Motion Sensor



SOCKET GROUP



2120 600 02XX
Earthed Socket



2120 601 02XX
Non Earthed Socket



2120 605 02XX
Earthed Socket (Child Prot.)



2120 606 02XX
Non Earthed Soc. -Child Prot.



2120 610 02XX
Earthed Socket With Cover



2120 611 02XX
Earthed Soc.Cover (Ch. Prot.)



2120 615 02XX
Ups (French) Soc. (Earthed)



2120 616 02XX
Ups (French) Soc. Child Prot.



2120 617 02XX
Ups (French) Soc. With Cover



2120 618 02XX
Ups (French) Soc. W/Cover (C.P.)



2120 448 01XX
1*Usb Charger



2120 449 01XX
2*Usb Charger

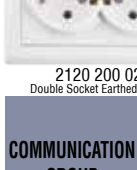

2120 200 02XX
Double Socket Earthed Porcelain



2120 201 02XX
Double Soc. Non Earthed Porcelain



2120 202 02XX
Double Socket Earthed



2120 203 02XX
Double Soc. Non Earthed



2120 215 01XX
Double Socket Ups



2120 125 01XX
Phonesocket 1*Rj12 (Cat3)



2120 126 01XX
Telephone Soc. 2xRj12



2120 128 01XX
TIF Data Soc. W/O Con. Label



2120 135 02XX
Data Soc. 1*Rj45w/Ocon.



2120 136 01XX
Data Soc. 1*Rj45 (Cat5e)



2120 137 01XX
Data Soc. 2*Rj45w/Ocon.



2120 138 01XX
Data Soc. 2*Rj45 (Cat5e)



2120 139 01XX
TIF Data Soc. (Rj12 Cat5e)



2120 140 01XX
Data Soc. 1*Rj45 (Cat6)



2120 141 01XX
Data Soc. 2*Rj45 (Cat6)



2120 455 01XX
Data Soc. 1*Usb



2120 456 01XX
Data Soc. 2*Usb



2120 457 01XX
Data Soc. 1*Hdmi



2120 458 01XX
Data Soc. 2*Hdmi



2120 459 01XX
Data Soc. 1*Usb/1*Hdmi



2120 460 01XX
Switch Vga Socket



2120 121 02XX
Blind Cover White



TV / SAT GROUP



2120 156 02XX
Tv-Sat Soc. Thr. 4db/Fcon.



2120 157 02XX
Tv-Sat Soc. (Dead End)



2120 166 01XX
Sat Soc. (Through) 4db/Fcon.



2120 167 01XX
Sat Soc. (Dead End)



2120 170 01XX
Tv Socket (Thr) 11db



2120 171 01XX
Tv Soc. (Dead End) 11db



2120 172 01XX
Tv Socket F Female



NATURAL



01 - WHITE



02 - CREAM

WOOD



56 - CHERRY



57 - WALNUTS



58 - OAK

METALLIC



80 - GOLD



82 - INOX



83 - TITANIUM



85 - DORE



84 - BLACK



95 - SMOKE



Daria

Mechanism + Plate Product List

Code	Product Description	Number of Box	Quantity of Package
Switch Group (With Screw)			
2120 401 02XX	One Gang One Way Switch	12	120
2120 402 02XX	Two Gang One Way Control	12	120
2120 403 02XX	One Gang Two Way Switch	12	120
2120 404 02XX	Two Gang Two Way Switch	12	120
2120 405 02XX	One Gang One Way Dp	12	120
2120 406 02XX	Blind Switch -W/Spring	12	120
2120 436 02XX	Jalousie Switch with screw without spring	12	120
2120 407 02XX	One Gang One Way Control	12	120
2120 407 02XXK	Door Switch	12	120
2120 407 02XXZ	Ring Switch	12	120
2120 408 02XX	One Gang Intermediate-Deviator	12	120
2120 409 02XX	3 Gang Switch	12	120
2120 411 02XX	Heater Switch	12	120
2120 415 02XX	Illu.1g.1w.Swi. (220v)	12	120
2120 416 02XX	Illu.One Gang Two Way (220v)	12	120
2120 417 02XX	Illu.1g.1w.Cntrl (220v)	12	120
2120 418 02XX	Illu.1g.1w.W/Lab. (220v)	12	120
2120 419 02XX	I.1g.1w.Ctrl W/Lab. (220v)	12	120
2120 422 02XX	Illu.1g.1w.Cntrl (12v)	12	120
2120 426 02XX	Illu.Two Gang One Way Switch	12	120
Switch Group (Easy Connection)			
2120 401 01XX	One Gang One Way Switch	12	120
2120 402 01XX	Two Gang One Way Control	12	120
2120 403 01XX	One Gang Two Way Switch	12	120
2120 404 01XX	Two Gang Two Way Switch	12	120
2120 405 01XX	One Gang One Way Dp	12	120
2120 406 01XX	Blind Switch -W/Spring	12	120
2120 436 01XX	Jalousie Switch, easy connection, without spring	12	120
2120 407 01XX	One Gang One Way Control	12	120
2120 407 01XXK	Door Switch	12	120
2120 407 01XXZ	Ring Switch	12	120
2120 408 01XX	One Gang Intermediate-Deviator	12	120
2120 409 01XX	3 Gang Switch	12	120
2120 415 01XX	Illu.1g.1w.Swi. (220v)	12	120
2120 416 01XX	Illu.One Gang Two Way (220v)	12	120
2120 417 01XX	Illu.1g.1w.Cntrl (220v)	12	120
2120 418 01XX	Illu.1g.1w.W/Lab. (220v)	12	120
2120 419 01XX	I.1g.1w.Ctrl W/Lab. (220v)	12	120
2120 422 01XX	Illu.1g.1w.Cntrl (12v)	12	120
2120 426 01XX	Illu.Two Gang One Way Switch	12	120
Dimmer Group			
2120 440 02XX	RL Rotary Dimmer 600W	8	80
2200 443 02XX	RL Rotary Dimmer (CE) 600W	8	80
2120 444 02XX	RL Rotary Dimmer 1000W	8	80
2120 447 02XX	RC Dimmer 325W	8	80
Electronics Group			
2120 450 01XX	Energy Saver Not Delay Illu.	8	80
2120 452 01XX	Energy Saver Delay Illu.	8	80
2120 470 02XX	Audio Switch	8	80
2120 480 01XX	Speaker Socket	8	80
2120 485 02XX	Warning Bell	8	80
2120 495 02XX	Motion Sensor	8	80
Socket Group			
2120 600 02XX	Earthed Socket	12	120
2120 601 02XX	Non Earthed Socket	12	120
2120 605 02XX	Earthed Socket (Child Protection)	12	120
2120 606 02XX	Non Earthed Socket -Child Protection	12	120
2120 610 02XX	Earthed Socket With Cover	12	120
2120 611 02XX	Earthed Socket Cover (Child Protection)	12	120
2120 615 02XX	Ups (French) Socket (Earthed)	12	120
2120 616 02XX	Ups (French) Socket Child Protection	12	120
2120 617 02XX	Ups (French) Soc. With Cover	12	120
2120 618 02XX	Ups (French) Soc.With Cover Child Pro	12	120
2125 200 02XX	Double Socket Earthed Porcelain	5	50
2125 201 02XX	Double Soc.Non Earthed Porcelain	5	50
2125 202 02XX	Double Socket Earthed	5	50
2125 203 02XX	Double Soc.Non Earthed	5	50
2125 215 02XX	Double Socket Ups	5	50
2120 448 01XX	Single USB charging socket	5	50
2120 449 01XX	Double usb charging socket	5	50



Daria

Mechanism + Plate Product List

Code	Product Description	Number of Box	Quantity of Package
------	---------------------	---------------	---------------------

Communication Group

2120 125 01XX	Phonesocket 1*Rj12 (Cat3)	12	120
2120 126 01XX	Telephone Soc.2xRJ12	12	120
2120 128 01XX	Tlf Data Soc.W/O Con. Label	12	120
2120 135 01XX	Data Soc.1*Rj45w/Ocon.	12	120
2120 136 01XX	Data Soc.1*Rj45 (Cat5e)	12	120
2120 137 01XX	Data Soc.2*Rj45w/Ocon.	12	120
2120 138 01XX	Data Soc.2*Rj45 (Cat5e)	12	120
2120 139 01XX	Tlf Data Soc.(Rj12 Cat5e)	12	120
2120 140 01XX	Data Soc.1*Rj45 (Cat6)	12	120
2120 141 01XX	Data Soc.2*Rj45 (Cat6)	12	120
2120 455 01XX	Data Soc.1*Usb	12	120
2120 456 01XX	Data Soc.2*Usb	12	120
2120 457 01XX	Data Soc.1*Hdmi	12	120
2120 458 01XX	Data Soc.2*Hdmi	12	120
2120 459 01XX	Data Soc. 1*Usb/1*Hdmi	12	120
2120 460 01XX	Switch Vga Socket	12	120
2120 121 02XX	Blind Cover White	12	120



Tv - Sat Group

2120 156 02XX	Tv-Sat Soc.Thr.4db/Fcon.	12	120
2120 157 02XX	Tv-Sat Soc.(Dead End)	12	120
2120 166 01XX	Sat Soc.(Through)4db/Fcon.	12	120
2120 167 01XX	Sat Soc.(Dead End)	12	120
2120 170 01XX	Tv Socket (Thr) 11db	12	120
2120 171 01XX	Tv Soc.(Dead End) 11db	12	120
2120 172 01XX	Tv Socket F Female	12	120
2120 173 01XX	Tv Socket Male (Through)	12	120
2120 174 01XX	Tv Socket Male (Dead End)	12	120



Frame

2120 800 11XX	One Gang Frame	20	400
2120 800 12XX	2g. Horizontal Frame	10	200
2120 800 13XX	3g. Horizontal Frame	10	50
2120 800 14XX	4g. Horizontal Frame	10	50
2120 800 15XX	5g. Horizontal Frame	10	50
2120 800 16XX	6g. Horizontal Frame	10	50
2120 800 22XX	2g. Vertical Frame	10	50
2120 800 23XX	3g. Vertical Frame	10	50
2120 800 24XX	4g. Vertical Frame	10	50
2120 800 25XX	5g. Vertical Frame	10	50
2120 800 26XX	6g. Vertical Frame	10	50
2120 820 12XX	Double Socket Frame	12	60
2100 000 11XX	Surface Mounted Case	12	60



BRON



Problem-free functional solutions at surface mounted applications.





White
 Cream
 01 02

BRON Natural

White / Cream

Code	Product Description	Number of Box	Quantity of Package
2160 301 02XX	One Gang One Way Switch	12	120
2160 302 02XX	Two Gang One Way Control	12	120
2160 303 02XX	One Gang Two Way Switch	12	120
2160 307 02XX	One Gang One Way Control	12	120
2160 315 02XX	Illu.1g.1w.Swi. (220v)	12	120
2160 316 02XX	Illu.One Gang Two Way (220v)	12	120
2160 317 02XX	Illu.1g.1w.Cntrl (220v)	12	120
2160 326 02XX	Illu.Two Gang One Way Switch	12	120
2160 100 02XX	Earthed Socket	12	120
2160 101 02XX	Non Earthed Socket	12	120
2160 103 02XX	Earthed Socket (Porcelain)	12	120
2160 104 02XX	Non Earthed Socket (Porcelain)	12	120
2160 110 02XX	Earthed Socket With Cover	12	120
2160 113 02XX	Earthed Socket With Cover (Porcelain)	12	120
2160 115 02XX	French Socket (UPS)	12	120
2160 125 02XX	Phonesocket 1*Rj12 (Cat3)	12	120
2160 136 02XX	Data Soc.1*Rj45 (Cat5e)	12	120
2160 166 02XX	Sat Soc.(Through)4db/Fcon.	12	120
2160 167 02XX	Sat Soc.(Dead End)	12	120
2160 170 02XX	Tv Socket (Thr) 11db	12	120
2160 171 02XX	Tv Soc.(Dead End) 11db	12	120
2160 200 02XX	Double Socket Earthed Porcelain	6	60
2160 201 02XX	Double Soc.Non Earthed Porcelain	6	60
2160 202 02XX	Double Socket Earthed	6	60
2160 203 02XX	Double Soc.Non Earthed	6	60
2160 215 02XX	Double Socket Ups	6	60

BRON Wood

Oac / Walnuts



Oam
 Walnuts
 58 57

Code	Product Description	Number of Box	Quantity of Package
2160 301 02XX	One Gang One Way Switch	12	120
2160 302 02XX	Two Gang One Way Control	12	120
2160 303 02XX	One Gang Two Way Switch	12	120
2160 307 02XX	One Gang One Way Control	12	120
2160 315 02XX	Illu.1g.1w.Swi. (220v)	12	120
2160 316 02XX	Illu.One Gang Two Way (220v)	12	120
2160 317 02XX	Illu.1g.1w.Cntrl (220v)	12	120
2160 326 02XX	Illu.Two Gang One Way Switch	12	120
2160 100 02XX	Earthed Socket	12	120
2160 101 02XX	Non Earthed Socket	12	120
2160 103 02XX	Earthed Socket (Porcelain)	12	120
2160 104 02XX	Non Earthed Socket (Porcelain)	12	120
2160 110 02XX	Earthed Socket With Cover	12	120
2160 113 02XX	Earthed Socket With Cover (Porcelain)	12	120
2160 115 02XX	French Socket (UPS)	12	120
2160 125 02XX	Phonesocket 1*Rj12 (Cat3)	12	120
2160 136 02XX	Data Soc.1*Rj45 (Cat5e)	12	120
2160 166 02XX	Sat Soc.(Through)4db/Fcon.	12	120
2160 167 02XX	Sat Soc.(Dead End)	12	120
2160 170 02XX	Tv Socket (Thr) 11db	12	120
2160 171 02XX	Tv Soc.(Dead End) 11db	12	120
2160 200 02XX	Double Socket Earthed Porcelain	6	60
2160 201 02XX	Double Soc.Non Earthed Porcelain	6	60
2160 202 02XX	Double Socket Earthed	6	60
2160 203 02XX	Double Soc.Non Earthed	6	60
2160 215 02XX	Double Socket Ups	6	60

Nemliyer



Safety- enhanced,
surface-mounted switch serie



IP44

Nemliyer Natural

Waterproof Switches

Code	Product Description	Number of Box	Quantity of Package
2150 001 01XX	One Gang One Way Switch	10	100
2150 002 01XX	Two Gang One Way Control	10	100
2150 003 01XX	One Gang Two Way Switch	10	100
2150 005 01XX	One Gang One Way Dp	10	100
2150 007 01XX	One Gang One Way Control	10	100
2150 008 01XX	One Gang Intermediate-Deviator	10	100
2150 110 02XX	Earthed Socket With Cover	8	80
2150 115 02XX	Ups (French) Socket (Earthed)	8	80
2150 125 02XX	Phonesocket 1*Rj12 (Cat3)	10	100
2150 136 01XX	Data Soc.1*Rj45 (Cat5e)	10	100
2150 166 02XX	Sat Soc.(Through)4db/Fcon.	10	100
2150 167 02XX	Sat Soc.(Dead End)	10	100
2150 170 02XX	Tv Socket (Thr) 11db	10	100
2150 171 02XX	Tv Soc.(Dead End) 11db	10	100



White-01

Gray-03

Nemliyer Wood

Waterproof Switches

Code	Product Description	Number of Box	Quantity of Package
2150 001 01XX	One Gang One Way Switch	10	100
2150 002 01XX	Two Gang One Way Control	10	100
2150 003 01XX	One Gang Two Way Switch	10	100
2150 005 01XX	One Gang One Way Dp	10	100
2150 007 01XX	One Gang One Way Control	10	100
2150 008 01XX	One Gang Intermediate-Deviator	10	100
2150 110 02XX	Earthed Socket With Cover	8	80
2150 115 02XX	Ups (French) Socket (Earthed)	8	80
2150 125 02XX	Phonesocket 1*Rj12 (Cat3)	10	100
2150 136 01XX	Data Soc.1*Rj45 (Cat5e)	10	100
2150 166 02XX	Sat Soc.(Through)4db/Fcon.	10	100
2150 167 02XX	Sat Soc.(Dead End)	10	100
2150 170 02XX	Tv Socket (Thr) 11db	10	100
2150 171 02XX	Tv Soc.(Dead End) 11db	10	100



MUT-40
Light Beech



MUT-41
Dark Walnuts



MUT-43
Merbau



MUT-44
Mahogany



MUT-49
Pear



Group Sockets Sockets & Switches

Shock protected, 2 USB charging, with/ without switch, UPS option, with/without cable, terminal block, double, triple, quadruple and six gangs options will meet your portable energy needs ...



NEW



Ri-tech Grup Socket

List of products

Code	Product Description	Number of Box
001 175 310002 03 00	3 GANG EARTHED GROUP SOC.(CHL PROTEC.)(3 MT)	12
001 175 310002 05 00	3 GANG EARTHED GROUP SOC.(CHL PROTEC.)(5 MT)	12
001 175 314002 01 00	3 GANG EARTHED GROUP SOC.(CHL PROTEC.)(1 MT)(3x1,5)	12
001 175 314002 02 00	3 GANG EARTHED GROUP SOC.(CHL PROTEC.)(2 MT)(3x1,5)	12
001 175 314002 03 00	3 GANG EARTHED GROUP SOC.(CHL PROTEC.)(3 MT)(3x1,5)	12
001 175 314002 05 00	3 GANG EARTHED GROUP SOC.(CHL PROTEC.)(5 MT)(3x1,5)	12
001 175 410001 00 00	4 GANG EARTHED GROUP SOC.(CHL PROTEC.)(W/OUT CABLE)	25
001 175 410002 01 00	4 GANG EARTHED GROUP SOC.(CHL PROTEC.)(1 MT)	12
001 175 410002 02 00	4 GANG EARTHED GROUP SOC.(CHL PROTEC.)(2 MT)	12
001 175 410002 03 00	4 GANG EARTHED GROUP SOC.(CHL PROTEC.)(3 MT)	12
001 175 410002 05 00	4 GANG EARTHED GROUP SOC.(CHL PROTEC.)(5 MT)	12
001 175 414002 01 00	4 GANG EARTHED GROUP SOC.(CHL PROTEC.)(1 MT)(3x1,5)	12
001 175 414002 02 00	4 GANG EARTHED GROUP SOC.(CHL PROTEC.)(2 MT)(3x1,5)	12
001 175 414002 03 00	4 GANG EARTHED GROUP SOC.(CHL PROTEC.)(3 MT)(3x1,5)	12
001 175 414002 05 00	4 GANG EARTHED GROUP SOC.(CHL PROTEC.)(5 MT)(3x1,5)	12
001 175 610001 00 00	6 GANG EARTHED GROUP SOC.(CHL PROTEC.)(W/OUT CABLE)	25
001 175 610002 01 00	6 GANG EARTHED GROUP SOC.(CHL PROTEC.)(1 MT)	12
001 175 610002 02 00	6 GANG EARTHED GROUP SOC.(CHL PROTEC.)(2 MT)	12
001 175 610002 03 00	6 GANG EARTHED GROUP SOC.(CHL PROTEC.)(3 MT)	12
001 175 610002 05 00	6 GANG EARTHED GROUP SOC.(CHL PROTEC.)(5 MT)	12
001 175 330001 00 00	3 GANG UPS GROUP SOC.(CHL PROTEC.)(W/OUT CABLE)	25
001 175 330002 02 00	3 GANG UPS GROUP SOC.(CHL PROTEC.)(2 MT)	12
001 175 330002 03 00	3 GANG UPS GROUP SOC.(CHL PROTEC.)(3 MT)	12
001 175 330002 05 00	3 GANG UPS GROUP SOC.(CHL PROTEC.)(5 MT)	12
001 175 334002 02 00	3 GANG UPS GROUP SOC.(CHL PROTEC.)(2 MT)(3x1,5)	12
001 175 334002 03 00	3 GANG UPS GROUP SOC.(CHL PROTEC.)(3 MT)(3x1,5)	12
001 175 334002 05 00	3 GANG UPS GROUP SOC.(CHL PROTEC.)(5 MT)(3x1,5)	12
001 175 430001 00 00	4 GANG UPS GROUP SOC.(CHL PROTEC.)(W/OUT CABLE)	25
001 175 430002 02 00	4 GANG UPS GROUP SOC.(CHL PROTEC.)(2 MT)	12
001 175 430002 03 00	4 GANG UPS GROUP SOC.(CHL PROTEC.)(3 MT)	12
001 175 430002 05 00	4 GANG UPS GROUP SOC.(CHL PROTEC.)(5 MT)	12
001 175 434002 02 00	4 GANG UPS GROUP SOC.(CHL PROTEC.)(2 MT)(3x1,5)	12
001 175 434002 03 00	4 GANG UPS GROUP SOC.(CHL PROTEC.)(3 MT)(3x1,5)	12
001 175 434002 05 00	4 GANG UPS GROUP SOC.(CHL PROTEC.)(5 MT)(3x1,5)	12
001 175 630001 00 00	6 GANG UPS GROUP SOC.(CHL PROTEC.)(W/OUT CABLE)	25
001 175 630002 02 00	6 GANG UPS GROUP SOC.(CHL PROTEC.)(2 MT)	12
001 175 630002 03 00	6 GANG UPS GROUP SOC.(CHL PROTEC.)(3 MT)	12
001 175 630002 05 00	6 GANG UPS GROUP SOC.(CHL PROTEC.)(5 MT)	12
001 175 650001 00 00	6 GANG UPS EARTHED GROUP SOC.(CHL PROTEC.)(W/OUT CAB.+ SWT.)	25
001 175 650002 02 00	6 GANG UPS EARTHED GROUP SOC.(CHL PROTEC.)(WITH SWITCH)(2 MT)	12
001 175 650002 03 00	6 GANG UPS EARTHED GROUP SOC.(CHL PROTEC.)(WITH SWITCH)(3 MT)	12
001 175 650002 05 00	6 GANG UPS EARTHED GROUP SOC.(CHL PROTEC.)(WITH SWITCH)(5 MT)	12
001 175 350001 00 00	3 GANG EARTHED GROUP SOC. WITH CURRENT PROTECTION 2XUSB CHARGER	25
001 175 350002 02 00	3 GANG EARTHED GROUP SOC. WITH CURRENT PROTECTION 2XUSB CHARGER	12
001 175 350002 03 00	3 GANG EARTHED GROUP SOC. WITH CURRENT PROTECTION 2XUSB CHARGER	12
001 175 350002 05 00	3 GANG EARTHED GROUP SOC. WITH CURRENT PROTECTION 2XUSB CHARGER	12

Ri-tech Current Protected Group Socket

Code	Product Description	Number of Box
001 175 660002 15 00	6 GANG EARTHED GROUP SOC. WITH CURRENT PROTECTION 2XUSB CHARGER (CHL PROTECTION+ WITH SWITCH) 1,5M CABLE	12
001 175 670002 15 00	6 GANG EARTHED GROUP SOC. WITH CURRENT PROTECTION (CHL PROTECTION+ WITH SWITCH) 1,5M CABLE	12

Ri-tech USB Changer

Code	Product Description	Number of Box
001 888 100002 00 00	DOUBLE USB CHARGER ADAPTER 2.4A	20

Olimpia Grup Socket

List of products



Code	Product Description	Number of Box
001 171 290001 00 00	2 GANG NON EARTHED GROUP SOCKET(W/OUT CABLE)	25
001 171 290002 02 00	2 GANG NON EARTHED GROUP SOCKET (2 MT)	12
001 171 290002 03 00	2 GANG NON EARTHED GROUP SOCKET (3 MT)	12
001 171 290002 05 00	2 GANG NON EARTHED GROUP SOCKET (5 MT)	12
001 171 390001 00 00	3 GANG NON EARTHED GROUP SOCKET(W/OUT CABLE)	25
001 171 390002 02 00	3 GANG SOCKET OUTLET 2 MT CABLE	12
001 171 390002 03 00	3 GANG SOCKET OUTLET 3 MT CABLE	12
001 171 390002 05 00	3 GANG SOCKET OUTLET 5 MT CABLE	12
001 171 210001 00 00	2 GANG GROUP SOCKET EARTHED(W/OUT CABLE)	25
001 171 210002 02 00	2 GANG EARTHED GROUP SOCKET(2 MT)	12
001 171 210002 03 00	2 GANG EARTHED GROUP SOCKET(3 MT)	12
001 171 210002 05 00	2 GANG EARTHED GROUP SOCKET(5 MT)	12
001 171 310001 00 00	3 GANG EARTHED SOCKET OUTLET CABLELESS	25
001 171 310002 02 00	3 GANG EARTHED GROUP SOCKET(2 MT)	12
001 171 310002 03 00	3 GANG EARTHED GROUP SOCKET(3 MT)	12
001 171 310002 05 00	3 GANG EARTHED GROUP SOCKET(5 MT)	12
001 171 320001 00 00	3 GANG EARTHED GROUP SOCKET(W/OUT CABLE- SWITCH)	25
001 171 320002 02 00	3 GANG EARTHED GROUP SOCKET(WITH SWITCH(2 MT)	12
001 171 320002 03 00	3 GANG EARTHED GROUP SOCKET(WITH SWITCH(5 MT)	12
001 171 320002 05 00	3 GANG EARTHED GROUP SOCKET(WITH SWITCH(3 MT)	12
001 171 340001 00 00	3 GANG UPS GROUP SOCKET(W/OUT CABLE)	25
001 171 330001 02 00	3 GANG UPS GROUP SOCKET(2 MT)	12
001 171 330001 03 00	3 GANG UPS GROUP SOCKET(3 MT)	12
001 171 330001 05 00	3 GANG UPS GROUP SOCKET(5 MT)	12
001 171 410001 00 00	4 GANG EARTHED GROUP SOCKET(W/OUT CABLE)	25
001 171 410001 02 00	4 GANG EARTHED GROUP SOCKET(2 MT)	12
001 171 410001 03 00	4 GANG EARTHED GROUP SOCKET(3 MT)	12
001 171 410001 05 00	4 GANG EARTHED GROUP SOCKET(5 MT)	12
001 171 410002 00 00	4 GANG EARTHED GROUP SOCKET(W/OUT CABLE-SWITCH	25
001 171 410002 02 00	4 GANG EARTHED GROUP SOCKET(WITH SWITCH(2 MT)	12
001 171 410002 03 00	4 GANG EARTHED GROUP SOCKET(WITH SWITCH(3 MT)	12
001 171 410002 05 00	4 GANG EARTHED GROUP SOCKET(WITH SWITCH(5 MT)	12
001 171 610001 00 00	EARTHED 6 GANG SOCKET OUTLET CABLELESS	25
001 171 610001 02 00	6 GANG EARTHED GROUP SOCKET(2 MT)	12
001 171 610001 03 00	6 GANG EARTHED GROUP SOCKET(3 MT)	12
001 171 610001 05 00	6 GANG EARTHED GROUP SOCKET(5 MT)	12
001 171 610002 00 00	6 GANG EARTHED GROUP SOCKET(W/OUT CABLE-WITH SWITCH	25
001 171 610002 02 00	6 GANG EARTHED GROUP SOCKET(WITH SWITCH (2 MT)	12
001 171 610002 03 00	6 GANG EARTHED GROUP SOCKET(WITH SWITCH (3 MT)	12
001 171 610002 05 00	6 GANG EARTHED GROUP SOCKET(WITH SWITCH (5 MT)	12
001 170 110001 00 00	10 GANG EARTHED GROUP SOCKET(W/OUT CABLE)	20

ACCESSORIES

List of products



CE

Code	001 170 012001 00 00
Name	Male Plug Earthed Tailed
Box	50



CE

Code	001 170 010001 00 00
Name	Male Plug
Box	50



CE

Code	001 170 013001 00 00
Name	UPS Male Plug Earthed Tailed
Box	50



CE

Code	001 170 020001 00 00
Name	Female Plug
Box	50



CE

Code	001 170 011001 00 00
Name	Male Plug Earthed
Box	50



CE

Code	001 170 021001 00 00
Name	Female Plug Earthed
Box	25



CE

Code	001 170 014001 00 00
Name	UPS Male Plug Earthed
Box	50



CE

Code	001 170 011002 00 00
Name	Male Plug Earth Handle
Box	50



CE

Code	001 170 051001 00 00
Name	Male Plug Earthed
Box	50



CE

Code	001 170 061001 00 00
Name	Female Plug Earthed
Box	25



CE

Code	001 170 050001 00 00
Name	Male Plug
Box	50



CE

Code	001 170 060001 00 00
Name	Female Plug
Box	50

ACCESSORIES

List of products



CE

Code	001 170 033001 00 00
Name	Clover Eart. 3 Gang Soc. Outlet Flush Mounted
Box	12



Code	001 888 000001 00 00
Name	Socketmatic Child Protection Cover
Box	100



CE

Code	001 170 033002 00 00
Name	Closer Eart. 3 Gang Soc. Outlet Surface M.
Box	20



CE

Code	001 170 033003 00 00
Name	2 Gang Socket Adapter
Box	24



Code	001 170 030002 00 00
Name	Adapter Bri. (BS 546) to Schuko (CEE 7/4)
Box	50



CE

Code	001 170 033005 00 00
Name	3 Gang Socket Adapter
Box	24



CE

Code	001 170 030001 00 00
Name	Bakalite Hand Switch
Box	50



CE

Code	001 170 033004 00 00
Name	3 Gang Socket Adapter (Switched)
Box	24

Child protection is provided with the help of this apparatus

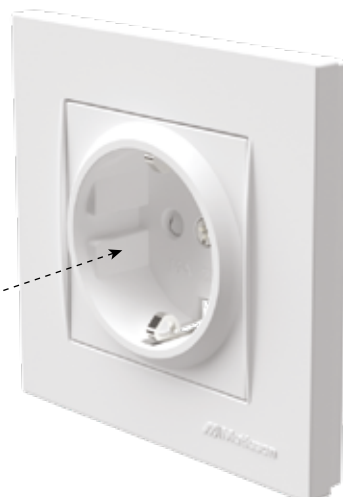

NEW

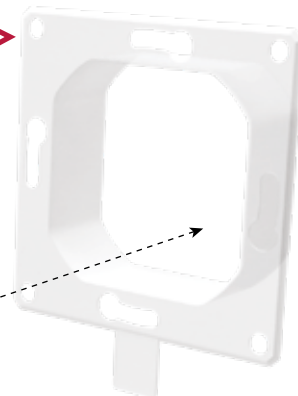

Safer with IP44 insulating frame



DISTRIBUTION BOARDS

Enjoy Quality and Advanced Technology...





OPENS ON TOP



001 026 00002 00 00



OPENS TO SIDE



Code	Product Description	Number of Box	Quantity of Pack
MEKSBOX CIRCUIT BREAKER BOXES			
	IP40		
001 027 200001 00 00	SEAL TYPE FUSE BOX (S/M) 1	20 pcs.	160
001 027 200002 00 00	SEAL TYPE FUSE BOX (S/M) 2	20 pcs.	80
001 027 200004 00 00	SEAL TYPE FUSE BOX (S/M) 4	10 pcs.	80
001 027 100002 00 00	MEKSBOX FUSE BOX SURFACE MOUNTED 2	1 pcs.	30
001 027 100004 00 00	MEKSBOX FUSE BOX SURFACE MOUNTED 4	1 pcs.	30
001 027 100006 00 00	MEKSBOX FUSE BOX SURFACE MOUNTED 6	1 pcs.	20
001 027 100009 00 00	MEKSBOX FUSE BOX SURFACE MOUNTED 9	1 pcs.	20
001 027 100012 00 00	MEKSBOX FUSE BOX SURFACE MOUNTED 12	1 pcs.	20
001 027 100016 00 00	MEKSBOX FUSE BOX SURFACE MOUNTED 16	1 pcs.	20
001 027 100024 00 00	MEKSBOX FUSE BOX SURFACE MOUNTED 24	1 pcs.	20
001 027 100036 00 00	MEKSBOX FUSE BOX SURFACE MOUNTED 36	1 pcs.	20
001 027 000002 00 00	MEKSBOX FUSE BOX FLUSH MOUNTED 2	1 pcs.	10
001 027 000004 00 00	MEKSBOX FUSE BOX FLUSH MOUNTED 4	1 pcs.	10
001 027 000006 00 00	MEKSBOX FUSE BOX FLUSH MOUNTED 6	1 pcs.	10
001 027 000009 00 00	MEKSBOX FUSE BOX FLUSH MOUNTED 9	1 pcs.	10
001 027 000012 00 00	MEKSBOX FUSE BOX FLUSH MOUNTED 12	1 pcs.	5
001 027 000016 00 00	MEKSBOX FUSE BOX FLUSH MOUNTED 16	1 pcs.	5
001 027 000024 00 00	MEKSBOX FUSE BOX FLUSH MOUNTED 24	1 pcs.	5
001 027 000036 00 00	MEKSBOX FUSE BOX FLUSH MOUNTED 36	1 pcs.	5

FUSE BOX COVER TOOL

001 026 00002 00 00	W OTOMAT COVER TOOL (12) NEW TYPE	50 pcs.	400
---------------------	-----------------------------------	---------	-----

COMFORT CIRCUIT BREAKER BOXES

Code	Product Description	Number of Box	Quantity of Pack
	IP40		
001 057 200001 00 00	COMFORT SURFACE MOUNTED SEALED FUSE BOX, 1 MODULE	20 pcs.	120
001 057 200002 00 00	COMFORT SURFACE MOUNTED SEALED FUSE BOX, 2 MODULES	20 pcs.	80
001 057 200004 00 00	COMFORT SURFACE MOUNTED SEALED FUSE BOX, 4 MODULES	10 pcs.	60
001 057 100006 00 00	COMFORT FUSE BOX SURFACE MOUNTED 6	1 pcs.	20
001 057 100009 00 00	COMFORT FUSE BOX SURFACE MOUNTED 9	1 pcs.	20
001 057 100012 00 00	COMFORT FUSE BOX SURFACE MOUNTED 12	1 pcs.	10
001 057 100018 00 00	COMFORT FUSE BOX SURFACE MOUNTED 18	1 pcs.	10
001 057 100024 00 00	COMFORT FUSE BOX SURFACE MOUNTED 24	1 pcs.	5
001 057 100036 00 00	COMFORT FUSE BOX SURFACE MOUNTED 36	1 pcs.	5
001 057 000006 00 00	COMFORT FUSE BOX FLUSH MOUNTED 6	1 pcs.	20
001 057 000009 00 00	COMFORT FUSE BOX FLUSH MOUNTED 9	1 pcs.	20
001 057 000012 00 00	COMFORT FUSE BOX FLUSH MOUNTED 12	1 pcs.	10
001 057 000018 00 00	COMFORT FUSE BOX FLUSH MOUNTED 18	1 pcs.	10
001 057 000024 00 00	COMFORT FUSE BOX FLUSH MOUNTED 24	1 pcs.	5
001 057 000036 00 00	COMFORT FUSE BOX FLUSH MOUNTED 36	1 pcs.	5

COMFORT W FUSE BOX ACCESSORIES

001 057 990001 00 00	FALSE WALL FIXING SET	1 pcs.	
001 057 990002 00 00	COMFORT BALANCE TOOL	1 pcs.	
000 700 000574 00 00	COMFORT RAIL RAISING SET	1 pcs.	
001 057 001236 00 00	COMFORT COVER TOOL	50 pcs.	

MEKSBOX FUSE BOXES (NON-FLAME)

Code	Product Description	Number of Box	Quantity of Pack
	CE IP40		
001 027 210001 00 00	SEAL TYPE FUSEBOX(H.FREE)NONFLAME(S/M)1	20 pcs.	160
001 027 210002 00 00	SEAL TYPE FUSEBOX(H.FREE)NONFLAME(S/M)2	20 pcs.	80
001 027 210004 00 00	SEAL TYPE FUSEBOX(H.FREE)NONFLAME(S/M)4	10 pcs.	80
001 027 110002 00 00	FUSE BOX SURFACE MOUNTED (H.FREE) NONFLAME 2	1 pcs.	30
001 027 110004 00 00	FUSE BOX SURFACE MOUNTED (H.FREE) NONFLAME 4	1 pcs.	30
001 027 110006 00 00	FUSE BOX SURFACE MOUNTED (H.FREE) NONFLAME 6	1 pcs.	20
001 027 110009 00 00	FUSE BOX SURFACE MOUNTED (H.FREE) NONFLAME 9	1 pcs.	20
001 027 110012 00 00	FUSE BOX SURFACE MOUNTED (H.FREE) NONFLAME 12	1 pcs.	20
001 027 110016 00 00	FUSE BOX SURFACE MOUNTED (H.FREE) NONFLAME 16	1 pcs.	20
001 027 110024 00 00	FUSE BOX SURFACE MOUNTED (H.FREE) NONFLAME 24	1 pcs.	20
001 027 110036 00 00	FUSE BOX SURFACE MOUNTED (H.FREE) NONFLAME 36	1 pcs.	20
001 027 010002 00 00	FUSE BOX FLUSH MOUNTED (H.FREE) NONFLAME 2	1 pcs.	10
001 027 010004 00 00	FUSE BOX FLUSH MOUNTED (H.FREE) NONFLAME 4	1 pcs.	10
001 027 010006 00 00	FUSE BOX FLUSH MOUNTED (H.FREE) NONFLAME 6	1 pcs.	10
001 027 010009 00 00	FUSE BOX FLUSH MOUNTED (H.FREE) NONFLAME 9	1 pcs.	10
001 027 010012 00 00	FUSE BOX FLUSH MOUNTED (H.FREE) NONFLAME 12	1 pcs.	5
001 027 010016 00 00	FUSE BOX FLUSH MOUNTED (H.FREE) NONFLAME 16	1 pcs.	5
001 027 010024 00 00	FUSE BOX FLUSH MOUNTED (H.FREE) NONFLAME 24	1 pcs.	5
001 027 010036 00 00	FUSE BOX FLUSH MOUNTED (H.FREE) NONFLAME 36	1 pcs.	5

COMFORT W FUSE BOXES (NON-FLAME)

Code	Product Description	Number of Box	Quantity of Pack
	CE IP40		
001 057 210001 00 00	COMFORT SURFACE MOUNTED SEALED FUSE BOX (NON FLAME) 1	20 pcs.	120
001 057 210002 00 00	COMFORT SURFACE MOUNTED SEALED FUSE BOX (NON FLAME) 2	20 pcs.	80
001 057 210004 00 00	COMFORT SURFACE MOUNTED SEALED FUSE BOX (NON FLAME) 4	10 pcs.	60
001 057 110006 00 00	COMFORT FUSE BOX SURFACE MOUNTED (NON-FLAME) 6	1 pcs.	20
001 057 110009 00 00	COMFORT FUSE BOX SURFACE MOUNTED (NON-FLAME) 9	1 pcs.	20
001 057 110012 00 00	COMFORT FUSE BOX SURFACE MOUNTED (NON-FLAME) 12	1 pcs.	10
001 057 110018 00 00	COMFORT FUSE BOX SURFACE MOUNTED (NON-FLAME) 18	1 pcs.	10
001 057 110024 00 00	COMFORT FUSE BOX SURFACE MOUNTED (NON-FLAME) 24	1 pcs.	5
001 057 110036 00 00	COMFORT FUSE BOX SURFACE MOUNTED (NON-FLAME) 36	1 pcs.	5
001 057 010006 00 00	COMFORT FUSE BOX FLUSH MOUNTED (NON-FLAME) 6	1 pcs.	20
001 057 010009 00 00	COMFORT FUSE BOX FLUSH MOUNTED (NON-FLAME) 9	1 pcs.	20
001 057 010012 00 00	COMFORT FUSE BOX FLUSH MOUNTED (NON-FLAME) 12	1 pcs.	10
001 057 010018 00 00	COMFORT FUSE BOX FLUSH MOUNTED (NON-FLAME) 18	1 pcs.	10
001 057 010024 00 00	COMFORT FUSE BOX FLUSH MOUNTED (NON-FLAME) 24	1 pcs.	5
001 057 010036 00 00	COMFORT FUSE BOX FLUSH MOUNTED (NON-FLAME) 36	1 pcs.	5

Code	Product Description	Number of Box	Quantity of Pack
COMFORT W FUSE BOXES H.FREE (FLAME-PROPAGATING)			
	IP40		
001 057 220001 00 00	COMFORT SURFACE MOUNTED SEALED FUSE BOX(H.FREE), 1 MODULE	20 pcs.	120
001 057 220002 00 00	COMFORT SURFACE MOUNTED SEALED FUSE BOX(H.FREE), 2 MOD.	20 pcs.	80
001 057 220004 00 00	COMFORT SURFACE MOUNTED SEALED FUSE BOX(H.FREE) ,4 MOD.	10 pcs.	60
001 057 120006 00 00	COMFORT FUSE BOX SURFACE MOUNTED (H.FREE) 6	1 pcs.	20
001 057 120009 00 00	COMFORT FUSE BOX SURFACE MOUNTED (H.FREE) 9	1 pcs.	20
001 057 120012 00 00	COMFORT FUSE BOX SURFACE MOUNTED (H.FREE) 12	1 pcs.	10
001 057 120018 00 00	COMFORT FUSE BOX SURFACE MOUNTED (H.FREE) 18	1 pcs.	10
001 057 120024 00 00	COMFORT FUSE BOX SURFACE MOUNTED (H.FREE) 24	1 pcs.	5
001 057 120036 00 00	COMFORT FUSE BOX SURFACE MOUNTED (H.FREE) 36	1 pcs.	5
001 057 020006 00 00	COMFORT FUSE BOX FLUSH MOUNTED (H.FREE) 6	1 pcs.	20
001 057 020009 00 00	COMFORT FUSE BOX FLUSH MOUNTED (H.FREE) 9	1 pcs.	20
001 057 020012 00 00	COMFORT FUSE BOX FLUSH MOUNTED (H.FREE) 12	1 pcs.	10
001 057 020018 00 00	COMFORT FUSE BOX FLUSH MOUNTED (H.FREE) 18	1 pcs.	10
001 057 020024 00 00	COMFORT FUSE BOX FLUSH MOUNTED (H.FREE) 24	1 pcs.	5
001 057 020036 00 00	COMFORT FUSE BOX FLUSH MOUNTED (H.FREE) 36	1 pcs.	5
COMFORT CIRCUIT BREAKER BOXES AND LOW-CURRENT BOXES			
001 057 101012 00 00	COMFORT FUSE BOX SURFACE MOUNTED 12 (WEAK CURRENT)	1 pcs.	10
001 057 101020 00 00	COMFORT FUSE BOX SURFACE MOUNTED (WEAK CURRENT) (270x340)	1 pcs.	5
001 057 101024 00 00	COMFORT FUSE BOX SURFACE MOUNTED 24 (WEAK CURRENT)	1 pcs.	5
001 057 101036 00 00	COMFORT FUSE BOX SURFACE MOUNTED 36 (WEAK CURRENT)	1 pcs.	5
001 057 001012 00 00	COMFORT FUSE BOX FLUSH MOUNTED 12 (WEAK CURRENT)	1 pcs.	10
001 057 001020 00 00	COMFORT FUSE BOX FLUSH MOUNTED (WEAK CURRENT) (243x318)	1 pcs.	5
001 057 001024 00 00	COMFORT FUSE BOX FLUSH MOUNTED 24 (WEAK CURRENT)	1 pcs.	5
001 057 001036 00 00	COMFORT FUSE BOX FLUSH MOUNTED 36 (WEAK CURRENT)	1 pcs.	5
COMFORT W AUTOMATIC WEAK CURRENT BOXES H.FREE (FLAME-PROPAGATING)			
001 057 121012 00 00	COMFORT SURFACE MOUN. (WEAK CURRENT)(H.FREE)(FLAMABLE)(225x270)	1 pcs.	10
001 057 121020 00 00	COMFORT SURFACE MOUN. (WEAK CURRENT)(H.FREE)(FLAMABLE)(270x340)	1 pcs.	5
001 057 121024 00 00	COMFORT 12 +WEAK CURRENT SURFACE MOUNTED (H.FREE)(FLAMABLE)	1 pcs.	5
001 057 121036 00 00	COMFORT 24 +WEAK CURRENT SURFACE MOUNTED (H.FREE)(FLAMABLE)	1 pcs.	5
001 057 021012 00 00	COMFORT FLUSH MOUN. (WEAK CURRENT)(H.FREE)(FLAMABLE)(205x250)	1 pcs.	10
001 057 021020 00 00	COMFORT FLUSH MOUN. (WEAK CURRENT)(H.FREE)(FLAMABLE)(243x318)	1 pcs.	5
001 057 021024 00 00	COMFORT 12 +WEAK CURRENT FLUSH MOUNTED (H.FREE)(FLAMABLE)	1 pcs.	5
001 057 021036 00 00	COMFORT 24 +WEAK CURRENT FLUSH MOUNTED (H.FREE)(FLAMABLE)	1 pcs.	5
COMFORT W AUTOMATIC WEAK CURRENT BOXES (FLAME RETARDANT)			
001 057 111012 00 00	COMFORT FUSE BOX SURFACE MOUNTED (FLAME RET.)(WEAK CURRENT) 12	1 pcs.	10
001 057 111020 00 00	COMFORT FUSE BOX SURFACE MOUNTED (FLAME R)(WEAK CURRENT)(270x340)	1 pcs.	5
001 057 111024 00 00	COMFORT FUSE BOX SURFACE MOUNTED (FLAME RET.)(WEAK CURRENT) 24	1 pcs.	5
001 057 111036 00 00	COMFORT FUSE BOX SURFACE MOUNTED (FLAME RET.)(WEAK CURRENT) 36	1 pcs.	5
001 057 011012 00 00	COMFORT FUSE BOX FLUSH MOUNTED (FLAME RET.)(WEAK CURRENT) 12	1 pcs.	10
001 057 011020 00 00	COMFORT FUSE BOX FLUSH MOUNTED (FLAME RET.)(WEAK CURRENT)(243x318)	1 pcs.	5
001 057 011024 00 00	COMFORT FUSE BOX FLUSH MOUNTED (FLAME RET.)(WEAK CURRENT) 24	1 pcs.	5
001 057 011036 00 00	COMFORT FUSE BOX FLUSH MOUNTED (FLAME RET.)(WEAK CURRENT) 36	1 pcs.	5
COMFORT W AUTOMATIC WEEK CURRENT BOXES (METAL)			
001 058 000012 00 00	12 MCB BOX METAL BASE + PLASTIC COVER FLUSH TYPE		
001 058 001012 00 00	WEEK CURRENT BOX METAL BASE + PLASTIC COVER FLUSH TYPE		
001 058 000024 00 00	24 MCB BOX METAL BASE + PLASTIC COVER FLUSH TYPE		
001 058 001024 00 00	12 MCB& WEEK CURRENT BOX METAL BASE + PLASTIC COVER FLUSH TYPE		
001 058 000036 00 00	36 MCB BOX METAL BASE + PLASTIC COVER FLUSH TYPE		
001 058 001036 00 00	24 MCB& WEEK CURRENT BOX METAL BASE + PLASTIC COVER FLUSH TYPE		



FOR A BETTER RESULT,
DO NOT FORGET TO
BUY TRUNKING
ACCESSORIES

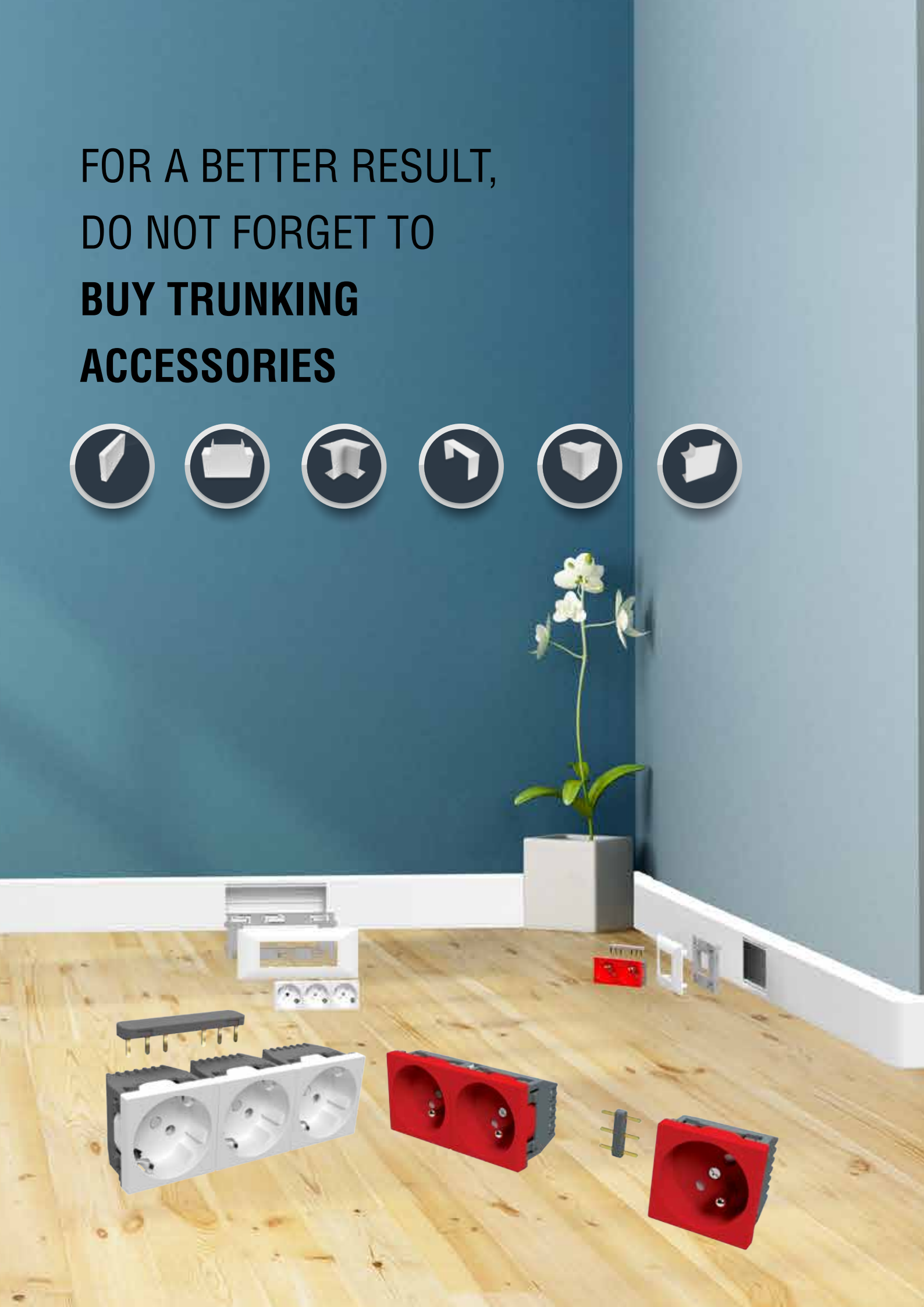



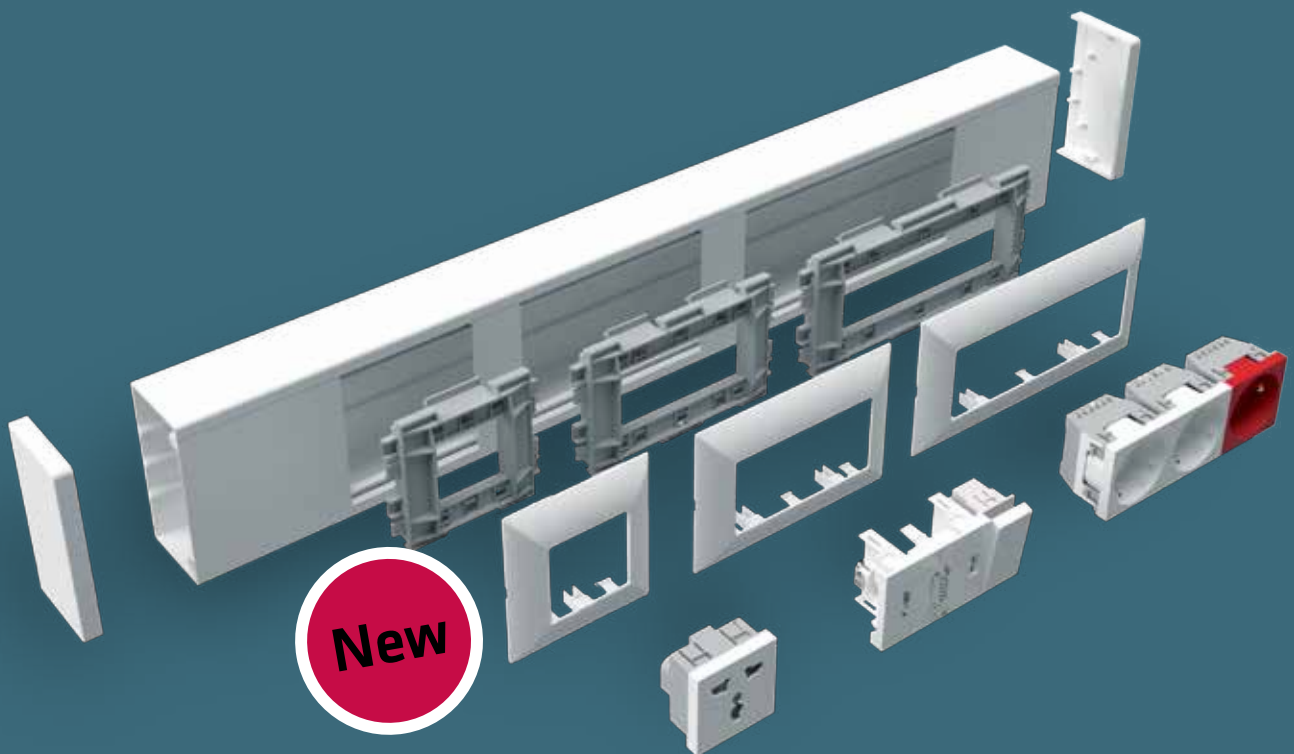

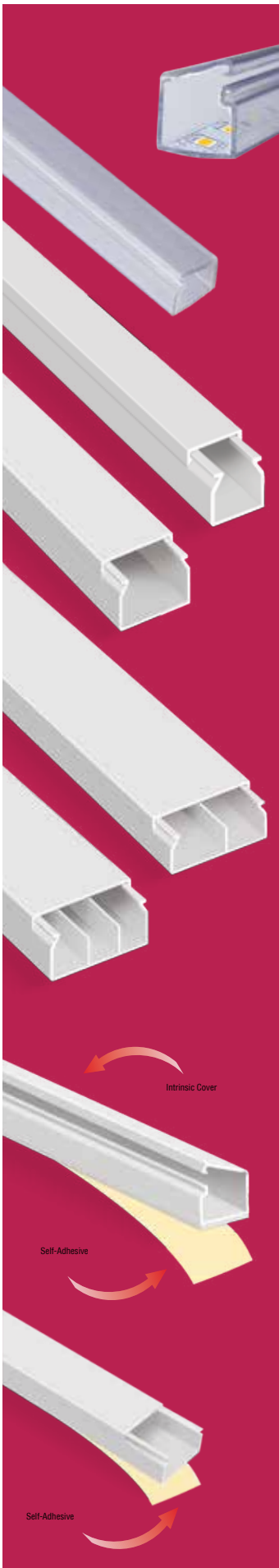
WITH **NEW NAIL STRUCTURE**
AND **RENEWED FRAMES**
STRONGER & SAFER





Code	Product Description	Number of Box	Quantity of Pack
FOR LED CABLE TRUNKING (TRANSPARENT)			
001 004 013012 20 44	13X12,5 CABLE TRUNKING ITSELF LID ADH.	300	mt.
CANALEX SERIES CLOSED TYPE CABLE TRUNKINGS (BOX)			
001 156 012012 20 00	12X12 CABLE TRUNKING CANALEX	250	mt.
001 156 015010 20 00	15X10 CABLE TRUNKING CANALEX	250	mt.
001 156 016016 20 00	16X16 CABLE TRUNKING CANALEX	250	mt.
001 156 020010 20 00	20X10 CABLE TRUNKING CANALEX	200	mt.
001 156 020015 20 00	20X15 CABLE TRUNKING CANALEX	200	mt.
001 156 025016 20 00	25X16 CABLE TRUNKING CANALEX	150	mt.
001 156 025025 20 00	25X25 CABLE TRUNKING CANALEX	100	mt.
001 156 030016 20 00	30X16 CABLE TRUNKING CANALEX	140	mt.
001 156 040016 20 00	40X16 CABLE TRUNKING CANALEX	100	mt.
001 156 040025 20 00	40X25 CABLE TRUNKING CANALEX	80	mt.
001 156 040040 20 00	40X40 CABLE TRUNKING CANALEX	50	mt.
001 156 060040 20 00	60X40 CABLE TRUNKING CANALEX	40	mt.
001 156 060060 20 00	60X60 CABLE TRUNKING CANALEX	32	mt.
001 156 080040 20 00	80X40 CABLE TRUNKING CANALEX	30	mt.
001 156 080060 20 00	80X60 CABLE TRUNKING CANALEX	24	mt.
001 156 100040 20 00	100X40 CABLE TRUNKING CANALEX	24	mt.
001 156 100050 20 00	100X50 CABLE TRUNKING CANALEX	20	mt.
001 156 100060 20 00	100X60 CABLE TRUNKING CANALEX	20	mt.
CANALEX SERIES CLOSED TYPE CABLE TRUNKINGS (SELF-ADHESIVE) (BOX)			
001 157 012012 20 00	12X12 CABLE TRUNKING CANALEX ADHESIVE	250	mt.
001 157 015010 20 00	15X10 CABLE TRUNKING CANALEX ADHESIVE	230	mt.
001 157 016016 20 00	16X16 CABLE TRUNKING CANALEX ADHESIVE	240	mt.
001 157 020010 20 00	20X10 CABLE TRUNKING CANALEX ADHESIVE	200	mt.
001 157 020015 20 00	20X15 CABLE TRUNKING CANALEX ADHESIVE	180	mt.
001 157 025016 20 00	25X16 CABLE TRUNKING CANALEX ADHESIVE	150	mt.
001 157 025025 20 00	25X25 CABLE TRUNKING CANALEX ADHESIVE	100	mt.
001 157 040016 20 00	40X16 CABLE TRUNKING CANALEX ADHESIVE	100	mt.
001 157 040025 20 00	40X25 CABLE TRUNKING CANALEX ADHESIVE	80	mt.
001 157 040040 20 00	40X40 CABLE TRUNKING CANALEX ADHESIVE	50	mt.
001 157 060040 20 00	60X40 CABLE TRUNKING CANALEX ADHESIVE	40	mt.
001 157 060060 20 00	60X60 CABLE TRUNKING CANALEX ADHESIVE	32	mt.
001 157 080040 20 00	80X40 CABLE TRUNKING CANALEX ADHESIVE	30	mt.
001 157 080060 20 00	80X60 CABLE TRUNKING CANALEX ADHESIVE	24	mt.
001 157 100040 20 00	100X40 CABLE TRUNKING CANALEX ADHESIVE	24	mt.
001 157 100060 20 00	100X60 CABLE TRUNKING CANALEX ADHESIVE	20	mt.
CANALEX SERIES CABLE TRUNKING (PLASTIC BAG)			
001 160 012012 20 00	12X12 CABLE TRUNKING CANALEX PACK	200	mt.
001 160 015010 20 00	15X10 CABLE TRUNKING CANALEX PACK	200	mt.
001 160 016016 20 00	16X16 CABLE TRUNKING CANALEX PACK	100	mt.
001 160 020010 20 00	20X10 CABLE TRUNKING CANALEX PACK	140	mt.
001 160 025016 20 00	25X16 CABLE TRUNKING CANALEX PACK	80	mt.
001 160 025025 20 00	25X25 CABLE TRUNKING CANALEX PACK	50	mt.
001 160 030016 20 00	30X16 CABLE TRUNKING CANALEX PACK	60	mt.
001 160 040016 20 00	40X16 CABLE TRUNKING CANALEX PACK	60	mt.
001 160 040025 20 00	40X25 CABLE TRUNKING CANALEX PACK	50	mt.
001 160 040040 20 00	40X40 CABLE TRUNKING CANALEX PACK	40	mt.
001 160 060040 20 00	60X40 CABLE TRUNKING CANALEX PACK	30	mt.
001 160 060060 20 00	60X60 CABLE TRUNKING CANALEX PACK	32	mt.
001 160 080040 20 00	80X40 CABLE TRUNKING CANALEX PACK	30	mt.
001 160 080060 20 00	80X60 CABLE TRUNKING CANALEX PACK	24	mt.
001 160 100040 20 00	100X40 CABLE TRUNKING CANALEX PACK	20	mt.
001 160 100060 20 00	100X60 CABLE TRUNKING CANALEX PACK	60	mt.
001 160 100048 20 00	100X48 CABLE TRUNKING CANALEX PACK	20	mt.
001 160 100100 20 00	100X100 CABLE TRUNKING CANALEX PACK	12	mt.
CANALEX SERIES CABLE TRUNKING (SELF-ADHESIVE) (PLASTIC BAG)			
001 161 012012 20 00	12X12 CABLE TRUNKING CANALEX ADHESIVE PACK	200	mt.
001 161 015010 20 00	15X10 CABLE TRUNKING CANALEX ADHESIVE PACK	200	mt.
001 161 016016 20 00	16X16 CABLE TRUNKING CANALEX ADHESIVE PACK	100	mt.
001 161 020010 20 00	20X10 CABLE TRUNKING CANALEX ADHESIVE PACK	140	mt.
001 161 020015 20 00	20X15 CABLE TRUNKING CANALEX ADHESIVE PACK	140	mt.
001 161 025016 20 00	25X16 CABLE TRUNKING CANALEX ADHESIVE PACK	80	mt.
001 161 025025 20 00	25X25 CABLE TRUNKING CANALEX ADHESIVE PACK	50	mt.
001 161 030016 20 00	30X16 CABLE TRUNKING CANALEX ADHESIVE PACK	60	mt.
001 161 040016 20 00	40X16 CABLE TRUNKING CANALEX ADHESIVE PACK	60	mt.
001 161 040025 20 00	40X25 CABLE TRUNKING CANALEX ADHESIVE PACK	50	mt.
001 161 040040 20 00	40X40 CABLE TRUNKING CANALEX ADHESIVE PACK	40	mt.
001 161 060040 20 00	60X40 CABLE TRUNKING CANALEX ADHESIVE PACK	30	mt.
001 161 060060 20 00	60X60 CABLE TRUNKING CANALEX ADHESIVE PACK	32	mt.
001 161 080040 20 00	80X40 CABLE TRUNKING CANALEX ADHESIVE PACK	30	mt.
001 161 080060 20 00	80X60 CABLE TRUNKING CANALEX ADHESIVE PACK	24	mt.
001 161 100040 20 00	100X40 CABLE TRUNKING CANALEX ADHESIVE PACK	20	mt.
001 161 100060 20 00	100X60 CABLE TRUNKING CANALEX ADHESIVE PACK	20	mt.
EKO SERIES CABLE TRUNKINGS (BOX)			
001 014 010008 20 00	10X8 CABLE TRUNKING	330	mt.
001 014 012012 20 00	12X12 CABLE TRUNKING	250	mt.
001 014 015010 20 00	15X10 CABLE TRUNKING	250	mt.
001 014 015015 20 00	15X15 CABLE TRUNKING	250	mt.
001 014 016016 20 00	16X16 CABLE TRUNKING	250	mt.
001 014 020010 20 00	20X10 CABLE TRUNKING	200	mt.
001 014 025016 20 00	25X16 CABLE TRUNKING	150	mt.
001 014 025025 20 00	25X25 CABLE TRUNKING	100	mt.
001 014 025040 20 00	25X40 CABLE TRUNKING	80	mt.
001 014 930010 20 00	30X10 CABLE TRUNKING(SEP)	140	mt.
001 014 030015 20 00	30X15 CABLE TRUNKING	140	mt.
001 014 930016 20 00	30X16 CABLE TRUNKING(SEP)	140	mt.
001 014 030016 20 00	30X16 CABLE TRUNKING	140	mt.
001 014 030025 20 00	30X25 CABLE TRUNKING	80	mt.

Code	Product Description	Number of Box	Quantity of Pack
001 014 030030 20 00	30X30 CABLE TRUNKING	80	mt.
001 014 940016 20 00	40X16 CABLE TRUNKING(SEP)	100	mt.
001 014 040016 20 00	40X16 CABLE TRUNKING	100	mt.
001 014 040025 20 00	40X25 CABLE TRUNKING	80	mt.
001 014 040040 20 00	40X40 CABLE TRUNKING	50	mt.
001 014 040060 20 00	40X60 CABLE TRUNKING	40	mt.
001 014 960025 20 00	60X25 CABLE TRUNKING(SEP)	40	mt.
001 014 060040 20 00	60X40 CABLE TRUNKING	40	mt.
001 014 050050 20 00	50X50 CABLE TRUNKING	30	mt.
001 014 060060 20 00	60X60 CABLE TRUNKING	32	mt.
001 014 075075 20 00	75X75 CABLE TRUNKING	28	mt.
001 014 080040 20 00	80X40 CABLE TRUNKING	30	mt.
001 014 080060 20 00	80X60 CABLE TRUNKING	24	mt.
001 014 100040 20 00	100X40 CABLE TRUNKING	24	mt.
001 014 100037 20 00	100X37 CABLE TRUNKING (IN. LID)	30	mt.
001 014 100050 20 00	100X50 CABLE TRUNKING (IN. LID)	20	mt.
001 014 100060 20 00	100X60 CABLE TRUNKING	20	mt.
001 014 120060 20 00	120X60 CABLE TRUNKING	16	mt.
001 014 100100 20 00	100X100 CABLE TRUNKING	20	mt.
EKO SERIES CABLE TRUNKINGS (SELF-ADHESIVE) (BOX)			
			
001 004 009005 20 00	9X5 CABLE TRUNKING ITSELF LID ADH.	500	mt.
001 004 010007 20 44	9,5X7 CABLE TRUNKING(TRANS.)(ADH.)	500	mt.
001 004 012007 20 00	12X7,5 CAB.TRUNK. ITSELF LID ADH.	350	mt.
001 004 013012 20 00	13X12,5 CAB.TRUNK. ITSELF LID ADH.	300	mt.
001 004 010008 20 00	10X8 CABLE TRUNKING(ADHESIVE)	330	mt.
001 004 010010 20 00	10X10 CABLE TRUNKING(ADHESIVE)	320	mt.
001 004 012012 20 00	12X12 CABLE TRUNKING(ADHESIVE)	250	mt.
001 004 015010 20 00	15X10 CABLE TRUNKING(ADHESIVE)	230	mt.
001 004 016016 20 00	16X16 CABLE TRUNKING(ADHESIVE)	240	mt.
001 004 020010 20 00	20X10 CABLE TRUNKING(ADHESIVE)	180	mt.
001 004 025016 20 00	25X16 CABLE TRUNKING(ADHESIVE)	150	mt.
001 004 025025 20 00	25X25 CABLE TRUNKING(ADHESIVE)	100	mt.
001 004 025040 20 00	25X40 CABLE TRUNKING(ADHESIVE)	80	mt.
001 004 930010 20 00	30X10 CABLE TRUNKING(ADHESIVE)(SEP.)	140	mt.
001 004 030016 20 00	30X16 CABLE TRUNKING(ADHESIVE)	140	mt.
001 004 030025 20 00	30X25 CABLE TRUNKING(ADHESIVE)	80	mt.
001 004 040016 20 00	40X16 CABLE TRUNKING(ADHESIVE)	100	mt.
001 004 040025 20 00	40X25 CABLE TRUNKING(ADHESIVE)	80	mt.
001 004 040040 20 00	40X40 CABLE TRUNKING(ADHESIVE)	50	mt.
001 004 060040 20 00	60X40 CABLE TRUNKING(ADHESIVE)	40	mt.
MEKS SERIES CLOSED TYPE CABLE TRUNKINGS			
			
001 002 015015 20 00	15X15 CABLE TRUNKING	250	mt.
001 002 016016 20 00	16X16 CABLE TRUNKING	250	mt.
001 002 025016 20 00	25X16 CABLE TRUNKING	150	mt.
001 002 025025 20 00	25X25 CABLE TRUNKING	100	mt.
001 002 030015 20 00	30X15 CABLE TRUNKING	140	mt.
001 002 030030 20 00	30X30 CABLE TRUNKING	80	mt.
001 002 040017 20 00	40X17 CABLE TRUNKING(N LID)	100	mt.
001 002 940017 20 00	40X17 CABLE TRUNKING(SEP)	100	mt.
001 002 040025 20 00	40X25 CABLE TRUNKING MEKS	80	mt.
001 002 040040 20 00	40X40 CABLE TRUNKING	50	mt.
001 002 960025 20 00	60X25 BASEBOARD CABLE TRUNK.SEP.	40	mt.
001 002 060040 20 00	60X40 CABLE TRUNKING MEKS	40	mt.
001 002 080060 20 00	80X60 CABLE TRUNKING MEKS	24	mt.
001 002 100036 20 00	100X36 CABLE TRUNKING MEKS	30	mt.
001 002 100040 20 00	100X40 CABLE TRUNKING MEKS	24	mt.
001 002 100048 20 00	100X48 CABLE TRUNKING MEKS	24	mt.
001 002 120070 20 00	120X70 CABLE TRUNKING MEKS (INT. COVER)(WITH ACCESSORIES)	16	mt.
001 002 170070 20 00	170X70 CABLE TRUNKING MEKS (INT. COVER)(WITH ACCESSORIES)	12	mt.
001 002 250070 20 00	250X70 CABLE TRUNKING MEKS (INT. COVER)(WITH ACCESSORIES)	8	mt.
001 002 100060 20 00	100X60 CABLE TRUNKING MEKS	20	mt.
001 002 120060 20 00	120X60 CABLE TRUNKING MEKS	16	mt.
MEKS SERIES CLOSED TYPE CABLE TRUNKINGS			
			
001 002 100037 20 00	100X37 CABLE TRUNKING MEKS (INTERNAL COVER)(PROT. BAND)	30	mt.
001 002 100041 20 00	100X41 CABLE TRUNKING MEKS (INTERNAL COVER)(PROT. BAND)	24	mt.
001 002 100050 20 00	100X50 CABLE TRUNKING MEKS (INTERNAL COVER)(PROT. BAND)	20	mt.
MEKSPPLUS SERIES CLOSED TYPE CABLE TRUNKINGS			
			
001 003 040025 20 00	40X25 CABLE TRUNKING(IN. LID)	80	mt.
001 003 100037 20 00	100X37 CABLE TRUNKING MEKS (IN. LID)	30	mt.
001 003 100041 20 00	100X41 CABLE TRUNKING(IN. LID)	24	mt.
001 003 100050 20 00	100X50 CABLE TRUNKING(IN. LID)	20	mt.
001 006 100050 20 00	100X50 C. TRUN.(IN. LID) Compatible with mounting without base	20	mt.
001 003 120070 20 00	120X70 CABLE TRUNKING(IN. LID)	16	mt.
001 003 170050 20 00	170X50 CABLE TRUNKING(IN. LID)	12	mt.
001 003 170070 20 00	170X70 CABLE TRUNKING(IN. LID)	12	mt.
001 003 250070 20 00	250X70 CABLE TRUNKING(IN. LID)	8	mt.
MEKS SERIES AIR CONDITIONER TRUNKING AND ACCESSORIES			
			
001 002 075060 20 00	75X60 AIR CONDITIONER TRUNKING	30	mt.
001 050 030002 00 00	AIR CONDITIONER TRUNKING CABLE FIXING TOOL	60	pcs.
001 043 075060 00 00	75X60 AIR CONDITIONER TRUNKING COUPLER FITTING	40	pcs.
001 039 075060 00 00	75X60 INSIDE CORNER (AIR COND.TRUNK.)	24	pcs.
001 040 075060 00 00	75X60 OUTSIDE CORNER(AIR COND.TRUNK.)	24	pcs.
001 042 075060 00 00	75X60 L CORNER (AIR COND.TRUNK.)	18	pcs.
001 050 030001 00 00	AIR CODITIONER TRUNK.WALL PASSING	60	pcs.
001 044 075060 01 00	75X60 INSIDE END CUP (AIR COND.TRUNK)	30	pcs.
001 044 075060 02 00	75X60 OUTSIDE END CUP (AIR COND.TRUNK)	18	pcs.





Code	Product Description	Number of Box	Quantity of Pack
------	---------------------	---------------	------------------

CEILING CORNER TRUNKING

001 002 023023 20 00	23X23 CABLE TRUNKING(CEILING CORNER)	120	mt.
001 041 023023 00 00	23X23 T CORNER	60	pcs.
001 042 023023 00 00	23X23 L CORNER	60	pcs.
001 043 023023 00 00	23X23 COUPLER FITTING	100	pcs.
001 044 023023 00 00	23X23 END CUP	100	pcs.

BASEBOARD CABLE TRUNKINGS AND ACCESSORIES

001 010 000200 20 00	50 MM BASEBOARD – LENGHT : 2 MT	60	mt.
001 014 974020 20 00	74 X 20 BASEBOARD CABLE TRUNKING SEPERATOR	50	mt.
001 002 975022 20 00	75X22 BASEBOARD CABLE TRUNK.SEP.	50	mt.
001 039 074020 00 00	74 X 20 INSIDE CORNER	20	pcs.
001 040 074020 00 00	74 X 20 OUTSIDE CORNER	20	pcs.
001 041 074020 00 00	T CORNER	30	pcs.
001 042 074020 01 00	L CORDER	40	pcs.
001 043 074020 00 00	COUPLER FITTING	50	pcs.
001 044 074020 00 00	END CUP	50	pcs.
001 047 017420 00 00	SOM FRAME (74 X 20)	6	pcs.
001 047 017421 00 00	SOM FRAME(45X45)(74X20)	12	pcs.
001 047 017423 00 00	SOM FRAME (74 X 20) (45X45) 3	12	pcs.
001 002 975022 20 00	75X22 BASEBOARD CABLE TRUNK.SEP.	50	mt.
001 039 075022 00 00	75X22 INSIDE CORNER	20	pcs.
001 040 075022 00 00	75X22 OUTSIDE CORNER	20	pcs.
001 044 075022 01 00	75X22 RIGHT END CUP	30	pcs.
001 044 075022 02 00	75X22 LEFT END CUP	20	pcs.
001 043 075022 00 00	75X22 COUPLER FITTING	100	pcs.

KITCHEN COUNTER CORNER TRUNKING

001 011 000100 00 00	25MM CORNER TRUNKING	60	mt.
----------------------	----------------------	----	-----

FLOOR CABLE TRUNKING

001 002 050013 20 17	50X13 CABLE TRUNKING (FLOOR)	60	mt.
001 002 060015 20 17	60X15 CABLE TRUNKING (FLOOR)	40	mt.
001 002 075018 20 17	75X18 CABLE TRUNKING (FLOOR)	30	mt.
001 002 090020 20 17	90X20 CABLE TRUNKING (FLOOR)	20	mt.
001 004 050013 20 17	50X13 CABLE TRUNKING(FLOOR)(ADHESIVE)	60	mt.
001 004 060015 20 17	60X15 CABLE TRUNKING(FLOOR)(ADHESIVE)	40	mt.
001 004 075018 20 17	75X18 CABLE TRUNKING(FLOOR)(ADHESIVE)	30	mt.
001 004 090020 20 17	90X20 CABLE TRUNKING(FLOOR)(ADHESIVE)	20	mt.

H.FREE FLARET SERIES CLOSED TYPE CABLE TRUNKINGS

001 060 100050 20 00	100X50 HALOGEN FREE CABLE TRUNKING	20	mt.
001 061 100050 20 00	100X50 CABLE TRUNKING SEPERATOR	150	mt.
001 039 100050 11 00	100X50 INSIDE CORNER(MOVING)(H.FREE)	12	pcs.
001 040 100050 11 00	100X50 OUTSIDE CORNER(MOVING)(H.FREE)	10	pcs.
001 041 100050 11 00	100X50 T CORNER(H.FREE)	10	pcs.
001 042 100050 11 00	100X50 L CORNER(H.FREE)	10	pcs.
001 043 100050 11 00	100X50 ADDITIONAL PART (TRIPLE SET)(H.FREE)	100	pcs.
001 044 100050 11 00	100X50 END CUP(H.FREE)	40	pcs.
001 047 100001 11 00	PMS(100X37/50)(45X45)(1 GANG)WITH INTERNAL CLIPS (H.FREE)	20	pcs.
001 047 100002 11 00	PMS(100X37/50)(45X45)(2 GANG)WITH INTERNAL CLIPS (H.FREE)	14	pcs.
001 047 100003 11 00	PMS(100X37/50)(45X45)(3 GANG)WITH INTERNAL CLIPS (H.FREE)	12	pcs.

H.FREE FLARET SERIES CLOSED TYPE CABLE TRUNKINGS

001 060 025016 20 00	25X16 CABLE TRUNKING (HALOGEN FREE)	150	mt.
001 060 025025 20 00	25X25 CABLE TRUNKING (HALOGEN FREE)	100	mt.
001 060 040025 20 00	40X25 CABLE TRUNKING (HALOGEN FREE)	80	mt.
001 060 040040 20 00	40X40 CABLE TRUNKING (HALOGEN FREE)	50	mt.

25X16 H.FREE SERIES TRUNKING ACCESSORIES

001 039 025016 11 00	25X16 INSIDE CORNER	40	pcs.
001 040 025016 11 00	25X16 OUTSIDE CORNER	40	pcs.
001 041 025016 11 00	25X16 T CORNER	30	pcs.
001 042 025016 11 00	25X16 L CORNER	50	pcs.
001 043 025016 11 00	25X16 COUPLER FITTING	100	pcs.
001 044 025016 11 00	25X16 END CUP	100	pcs.

25X25 H.FREE SERIES TRUNKING ACCESSORIES

001 039 025025 11 00	25X25 INSIDE CORNER	40	pcs.
001 040 025025 11 00	25X25 OUTSIDE CORNER	40	pcs.
001 041 025025 11 00	25X25 T CORNER	30	pcs.
001 042 025025 11 00	25X25 L CORNER	50	pcs.
001 043 025025 11 00	25X25 COUPLER FITTING	100	pcs.
001 044 025025 11 00	25X25 END CUP	100	pcs.









40X25 H.FREE SERIES TRUNKING ACCESSORIES

001 039 040025 11 00	40X25 INSIDE CORNER	24	pcs.
001 040 040025 11 00	40X25 OUTSIDE CORNER	30	pcs.
001 041 040025 11 00	40X25 T CORNER	18	pcs.
001 042 040025 11 00	40X25 L CORNER	24	pcs.
001 043 040025 11 00	40X25 COUPLER FITTING	70	pcs.
001 044 040025 11 00	40X25 END CUP	25	pcs.

40X40 H.FREE SERIES TRUNKING ACCESSORIES

001 039 040040 11 00	40X40 INSIDE CORNER	18	pcs.
001 040 040040 11 00	40X40 OUTSIDE CORNER	10	pcs.
001 041 040040 11 00	40X40 T CORNER	48	pcs.
001 042 040040 11 00	40X40 L CORNER	60	pcs.
001 043 040040 11 00	40X40 COUPLER FITTING	100	pcs.
001 044 040040 11 00	40X40 END CUP	25	pcs.



Code	Product Description	Number of Box	Quantity of Pack
ACCESSORIES FOR 60X15 FLOOR TRUNKINGS			
001 042 060015 00 17	60X15 L CORNER (FLOOR)	24	pcs.
001 043 060015 00 17	60X15 COUPLER FITTING (FLOOR)	50	pcs.
001 044 060015 00 17	60X15 END CUP (FLOOR)	50	pcs.
001 041 060015 00 17	60X15 T CORNER (FLOOR)	10	pcs.
ACCESSORIES FOR 75X18 FLOOR TRUNKINGS			
001 042 075018 00 17	75X18 L CORNER (FLOOR)	15	pcs.
001 043 075018 00 17	75X18 COUPLER FITTING (FLOOR)	50	pcs.
001 044 075018 00 17	75X18 END CUP FLOOR)	50	pcs.
001 041 075018 00 17	75X18 T CORNER (FLOOR)	8	pcs.
ACCESSORIES FOR 90X20 FLOOR TRUNKINGS			
001 042 090020 00 17	COIN L 90X20	20	pcs.
001 043 090020 00 17	90X20 COUPLER FITTING	50	pcs.
001 044 090020 00 17	90X20 END CUP (FLOOR)	50	pcs.
001 041 090020 00 17	90X20 T CORNER (FLOOR)	12	pcs.
12X12 TRUNKING ACCESSORIES  CE IP40			
001 039 012012 00 00	12X12 INSIDE CORNER	60	pcs.
001 040 012012 00 00	12X12 OUTSIDE CORNER	60	pcs.
001 041 012012 00 00	12X12 T CORNER	60	pcs.
001 042 012012 00 00	12X12 L CORNER	60	pcs.
001 044 012012 00 00	12X12 END CUP	100	pcs.
001 043 012012 00 00	12X12 COUPLER FITTING	100	pcs.
15X10 TRUNKING ACCESSORIES  CE IP40			
001 039 015010 00 00	15X10 INSIDE CORNER	60	pcs.
001 040 015010 00 00	15X10 OUTSIDE CORNER	60	pcs.
001 041 015010 00 00	15X10 T CORNER	60	pcs.
001 042 015010 00 00	15X10 L CORNER	60	pcs.
001 044 015010 00 00	15X10 END CUP	100	pcs.
001 043 016016 00 00	16X16 COUPLER FITTING	100	pcs.
20X10 TRUNKING ACCESSORIES  CE IP40			
001 039 020010 00 00	20X10 INSIDE CORNER	60	pcs.
001 040 020010 00 00	20X10 OUTSIDE CORNER	60	pcs.
001 041 020010 00 00	20X10 T CORNER	30	pcs.
001 042 020010 00 00	20X10 L CORNER	50	pcs.
001 044 020010 00 00	20X10 END CUP	100	pcs.
001 043 020010 00 00	20X10 COUPLER FITTING	100	pcs.
16X16 TRUNKING ACCESSORIES  CE IP40			
001 039 016016 00 00	16X16 INSIDE CORNER	100	pcs.
001 040 016016 00 00	16X16 OUTSIDE CORNER	100	pcs.
001 041 016016 00 00	16X16 T CORNER	60	pcs.
001 042 016016 00 00	16X16 L CORNER	60	pcs.
001 044 016016 00 00	16X16 END CUP	100	pcs.
001 043 016016 00 00	16X16 COUPLER FITTING	100	pcs.
25X16 TRUNKING ACCESSORIES  CE IP40			
001 039 025016 00 00	25X16 INSIDE CORNER	40	pcs.
001 040 025016 00 00	25X16 OUTSIDE CORNER	40	pcs.
001 041 025016 00 00	25X16 T CORNER	30	pcs.
001 042 025016 00 00	25X16 L CORNER	50	pcs.
001 044 025016 00 00	25X16 END CUP	100	pcs.
001 043 025016 00 00	25X16 COUPLER FITTING	100	pcs.
001 047 017421 00 00	SOM FRAME(45X45)(74X20)	12	pcs.
25X25 TRUNKING ACCESSORIES  CE IP40			
001 039 025025 00 00	25X25 INSIDE CORNER	40	pcs.
001 040 025025 00 00	25X25 OUTSIDE CORNER	40	pcs.
001 041 025025 00 00	25X25 T CORNER	24	pcs.
001 042 025025 00 00	25X25 L CORNER	40	pcs.
001 044 025025 00 00	25X25 END CUP	100	pcs.
001 043 025025 00 00	25X25 COUPLER FITTING	50	pcs.
001 047 017421 00 00	SOM FRAME(45X45)(74X20)	12	pcs.
30X10 TRUNKING ACCESSORIES  CE IP40			
001 039 030010 00 00	30X10 INSIDE CORNER	50	pcs.
001 040 030010 00 00	30X10 OUTSIDE CORNER	50	pcs.
001 041 030010 00 00	30X10 T CORNER	50	pcs.
001 042 030010 00 00	30X10 L CORNER	50	pcs.
001 044 030010 00 00	30X10 END CUP	100	pcs.
001 043 030010 00 00	30X10 COUPLER FITTING	100	pcs.
30X16 TRUNKING ACCESSORIES  CE IP40			
001 039 030016 00 00	30X16 INSIDE CORNER	35	pcs.
001 040 030016 00 00	30X16 OUTSIDE CORNER	48	pcs.
001 041 030016 00 00	30X16 T CORNER	40	pcs.
001 042 030016 00 00	30X16 L CORNER	50	pcs.
001 044 030016 00 00	30X16 END CUP	100	pcs.
001 043 030016 00 00	30X16 COUPLER FITTING	100	pcs.



COUPLER FITTING



T CORNER

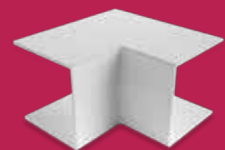

INSIDE CORNER



OUTSIDE CORNER











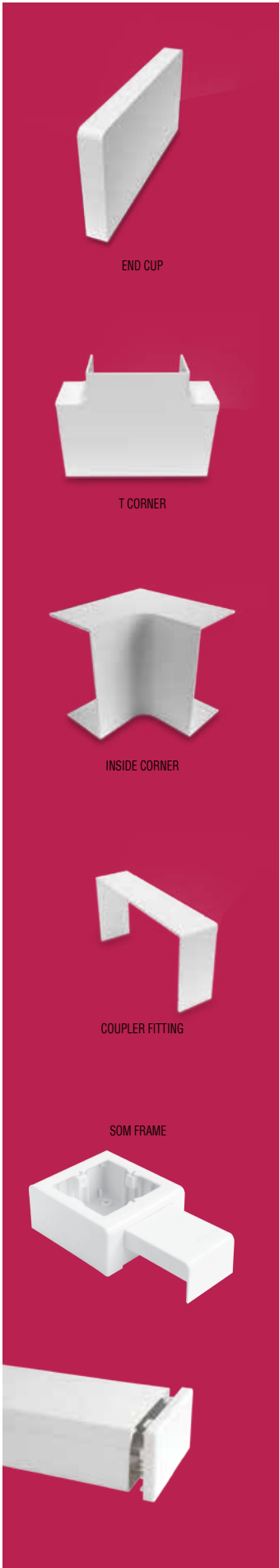

L CORNER









END CUP



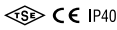

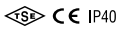
Code	Product Description	Number of Box	Quantity of Pack
30X25 TRUNKING ACCESSORIES  CE IP40			
001 039 030025 00 00	30X25 INSIDE CORNER	30	pcs.
001 040 030025 00 00	30X25 OUTSIDE CORNER	32	pcs.
001 041 030025 00 00	30X25 T CORNER	24	pcs.
001 042 030025 00 00	30X25 L CORNER	30	pcs.
001 044 030025 00 00	30X10-16-25 END CUP	100	pcs.
001 043 030025 00 00	30X16-30X25 COUPLER FITTING	100	pcs.
40X16 TRUNKING ACCESSORIES  CE IP40			
001 039 040016 00 00	40X16 INSIDE CORNER	32	pcs.
001 040 040016 00 00	40X16 OUTSIDE CORNER	30	pcs.
001 041 040016 00 00	40X16 T CORNER	24	pcs.
001 042 040016 00 00	40X16 L CORNER	34	pcs.
001 044 040016 00 00	40X16 END CUP	25	pcs.
001 043 040016 00 00	40X16-40X25-40X40 COUPLER FITTING	100	pcs.
001 047 017421 00 00	SOM FRAME(45X45)(74X20)	12	pcs.
40X25 TRUNKING ACCESSORIES  CE IP40			
001 039 040025 00 00	40X25 INSIDE CORNER	24	pcs.
001 040 040025 00 00	40X25 OUTSIDE CORNER	30	pcs.
001 041 040025 00 00	40X25 T CORNER	18	pcs.
001 042 040025 00 00	40X25 L CORNER	24	pcs.
001 044 040025 00 00	40X25 END CUP	25	pcs.
001 043 040016 00 00	40X16-40X25-40X40 COUPLER FITTING	100	pcs.
001 047 017421 00 00	SOM FRAME(45X45)(74X20)	12	pcs.
40X40 TRUNKING ACCESSORIES  CE IP40			
001 039 040040 00 00	40X40 INSIDE CORNER	18	pcs.
001 040 040040 00 00	40X40 OUTSIDE CORNER	10	pcs.
001 041 040040 00 00	40X40 T CORNER	48	pcs.
001 042 040040 00 00	40X40 L CORNER	60	pcs.
001 044 040040 00 00	40X40-40X25-40X16 END CUP	25	pcs.
001 043 040016 00 00	40X16-40X25-40X40 COUPLER FITTING	100	pcs.
001 047 017421 00 00	SOM FRAME(45X45)(74X20)	12	pcs.
60X25 TRUNKING ACCESSORIES  CE IP40			
001 039 060025 00 00	60X25 INSIDE CORNER	48	pcs.
001 040 060025 00 00	60X25 OUTSIDE CORNER	72	pcs.
001 041 060025 00 00	60X25 T CORNER	40	pcs.
001 042 060025 00 00	60X25 L CORNER	60	pcs.
001 044 060025 00 00	60X25 END CUP	50	pcs.
001 043 060025 00 00	60X25 COUPLER FITTING	60	pcs.
60X40 TRUNKING ACCESSORIES  CE IP40			
001 039 060040 00 00	60X40 INSIDE CORNER	26	pcs.
001 040 060040 00 00	60X40 OUTSIDE CORNER	32	pcs.
001 041 060040 00 00	60X40 T CORNER	32	pcs.
001 042 060040 00 00	60X40 L CORNER	40	pcs.
001 044 060040 00 00	60X40 END CUP	50	pcs.
001 043 060040 00 00	60X40 COUPLER FITTING	40	pcs.
60X60 TRUNKING ACCESSORIES  CE IP40			
001 039 060060 01 00	60X60-60X40-60X25 INTERNAL CORNER MOVABLE	16	pcs.
001 040 060060 01 00	Outer Corner Movable	16	pcs.
001 041 060060 00 00	60X60 T CORNER	20	pcs.
001 042 060060 00 00	60X60 L CORNER	24	pcs.
001 044 060060 00 00	60X60 END CUP	30	pcs.
001 043 060060 00 00	60X60 COUPLER FITTING	25	pcs.
80X40 TRUNKING ACCESSORIES  CE IP40			
001 039 080040 00 00	80X40 INSIDE CORNER	18	pcs.
001 040 080040 00 00	80X40 OUTSIDE CORNER	8	pcs.
001 041 080040 00 00	80X40 T CORNER	12	pcs.
001 042 080040 00 00	80X40 L CORNER	16	pcs.
001 044 080040 00 00	80X40 END CUP	60	pcs.
001 043 080040 00 00	80X40 COUPLER FITTING	100	pcs.
80X60 TRUNKING ACCESSORIES  CE IP40			
001 039 080060 00 00	80X60 INSIDE CORNER	12	pcs.
001 040 080060 00 00	80X60 OUTSIDE CORNER	8	pcs.
001 041 080060 00 00	80X60 T CORNER	10	pcs.
001 042 080060 00 00	80X60 L CORNER	12	pcs.
001 044 080060 00 00	80X60 END CUP	48	pcs.
001 043 080060 00 00	80X60 COUPLER FITTING	80	pcs.
100X36 TRUNKING ACCESSORIES  CE IP40			
001 039 100036 00 00	100X36 INSIDE CORNER(FIXED)	8	pcs.
001 040 100036 00 00	100X36 OUTSIDE CORNER(FIXED)	8	pcs.
001 039 100040 01 00	100X36 MM INTERNAL CORNER MOVABLE	8	pcs.
001 040 100040 01 00	100X36 MM OUTER CORNER MOVABLE	10	pcs.
001 041 100036 00 00	100X36 T CORNER	12	pcs.
001 042 100036 00 00	100X36 L CORNER	12	pcs.
001 044 100036 00 00	100X36 END CUP	16	pcs.
001 043 100036 00 00	100X36 COUPLER FITTING	100	pcs.
001 050 030004 00 00	100X36 TRUNKING LOCKING TOOL	100	pcs.
001 013 100036 20 00	100X36 CABLE TRUNK.(SEPARATOR)	200	mt.

Code	Product Description	Number of Box	Quantity of Pack
100X37 TRUNKING ACCESSORIES 			
001 039 100037 00 00	100X37 INSIDE CORNER(FIXED)	12	pcs.
001 040 100037 00 00	100X37 OUTSIDE CORNER(FIXED)	8	pcs.
001 039 100050 01 00	100X37 MM INTERNAL CORNER MOVABLE	12	pcs.
001 040 100050 01 00	100X37 MM OUTER CORNER MOVABLE	10	pcs.
001 041 100037 00 00	100X37 T CORNER	14	pcs.
001 042 100037 00 00	100X37 L CORNER	14	pcs.
001 044 100037 00 00	100X37 END CUP	50	pcs.
001 043 100037 00 00	100X37 COUPLER FITTING	100	pcs.
100X40 TRUNKING ACCESSORIES 			
001 039 100040 00 00	100X40 INSIDE CORNER(FIXED)	8	pcs.
001 040 100040 00 00	100X40 OUTSIDE CORNER(FIXED)	8	pcs.
001 039 100040 01 00	100X36 MM INTERNAL CORNER MOVABLE	16	pcs.
001 040 100040 01 00	100X36 MM OUTER CORNER MOVABLE	10	pcs.
001 041 100040 00 00	100X40 T CORNER	12	pcs.
001 042 100040 00 00	100X40 L CORNER	12	pcs.
001 044 100040 00 00	100X40 END CUP	20	pcs.
001 043 100040 00 00	100X40 COUPLER FITTING	100	pcs.
001 050 030004 00 00	100X36 TRUNKING LOCKING TOOL	100	pcs.
001 013 100040 20 00	100X40 CABLE TRUNK.(SEPARATOR)	200	mt.
100X48 TRUNKING ACCESSORIES 			
001 039 100048 00 00	100X48 INSIDE CORNER(FIXED)	8	pcs.
001 040 100048 00 00	100X48 OUTSIDE CORNER(FIXED)	8	pcs.
001 039 100060 01 00	100X60 INSIDE CORNER(MOVING)	10	pcs.
001 040 100060 01 00	100X60-100X48 OUTSIDE CORNER(MOVING)	10	pcs.
001 041 100048 00 00	100X48 T CORNER	8	pcs.
001 042 100048 00 00	100X48 L CORNER	8	pcs.
001 044 100048 00 00	100X48 END CUP	20	pcs.
001 043 100048 00 00	100X48 COUPLER FITTING	100	pcs.
001 050 030004 00 00	100X36 TRUNKING LOCKING TOOL	100	pcs.
001 013 100048 20 00	100X48 CABLE TRUNK.(SEPARATOR)	150	mt.
100X50 TRUNKING ACCESSORIES 			
001 039 100050 00 00	100X50 INSIDE CORNER (FIXED)	8	pcs.
001 040 100050 00 00	100X50 OUTSIDE CORNER (FIXED)	8	pcs.
001 039 100050 01 00	100X37 MM INTERNAL CORNER MOVABLE	12	pcs.
001 040 100050 01 00	100X37 MM OUTER CORNER MOVABLE	10	pcs.
001 041 100050 00 00	100X50 T CORNER	10	pcs.
001 042 100050 00 00	100X50 L CORNER	10	pcs.
001 044 100050 00 00	100X50 END CUP	40	pcs.
001 043 100050 00 00	100X50 COUPLER FITTING	100	pcs.
001 043 100050 01 00	100X50 COUPLER (3 PCS)	100	pcs.
001 046 195100 00 00	100X50 INTRA-DUCT CUBE JUNCTION BOXES	25	pcs.
100X50 WITHOUT BASE TRUNKING ACCESSORIES 			
001 039 100051 00 00	100X50 INSIDE CORNER (FIXED)	8	pcs.
001 040 100051 00 00	100X50 OUTSIDE CORNER (FIXED)	8	pcs.
001 041 100051 00 00	100X50 T CORNER	10	pcs.
001 042 100051 00 00	100X50 L CORNER	10	pcs.
001 043 100051 00 00	100X50 COUPLER FITTING	100	pcs.
001 044 100051 00 00	100X50 END CUP	40	pcs.
001 888 100050 00 00	100X50 KPMS SERIES LOCKING APPARATUS	50	mt.
100X60 TRUNKING ACCESSORIES 			
001 039 100060 00 00	100X60 INSIDE CORNER (FIXED)	8	pcs.
001 040 100060 00 00	100X60 OUTSIDE CORNER (FIXED)	8	pcs.
001 039 100060 01 00	100X60 INSIDE CORNER(MOVING)	8	pcs.
001 040 100060 01 00	100X60-100X48 OUTSIDE CORNER(MOVING)	10	pcs.
001 041 100060 00 00	100X60 T CORNER	8	pcs.
001 042 100060 00 00	100X60 L CORNER	8	pcs.
001 044 100060 00 00	100X36-40-48-60 END CUP	20	pcs.
001 043 100060 00 00	100X36-40-48-60 COUPLER FITTING	100	pcs.
001 050 030004 00 00	100X36 TRUNKING LOCKING TOOL	100	pcs.
001 013 100060 20 00	100X60 CABLE TRUNKING (SEPARATOR)	130	mt.
120X60 TRUNKING ACCESSORIES 			
001 039 120060 00 00	120X60 INSIDE CORNER	8	pcs.
001 040 120060 00 00	120X60 OUTSIDE CORNER	8	pcs.
001 041 120060 00 00	120X60 T CORNER	8	pcs.
001 042 120060 00 00	120X60 L CORNER	8	pcs.
001 044 120060 00 00	120X60 END CUP	20	pcs.
001 043 120060 00 00	120X60 COUPLER FITTING	50	pcs.
170X50 TRUNKING ACCESSORIES 			
001 039 170050 00 00	170X50 INSIDE CORNER	32	pcs.
001 040 170050 00 00	170X50 OUTSIDE CORNER	8	pcs.
001 041 170050 00 00	170X50 T CORNER	16	pcs.
001 042 170050 00 00	170X50 L CORNER	16	pcs.
001 044 170050 00 00	170X50 END CUP	125	pcs.
001 043 170050 00 00	170X50 COUPLER FITTING	125	pcs.
BRITISH NORM PLUG SOCKET ASSEMBLY SETS			
001 047 980001 00 00	BRITISH NORM SIGNLE SOCKET BASE	200	pcs.
001 047 980002 00 00	BRITISH NORM DOUBLE SOCKET BASE	100	pcs.
001 047 990002 00 00	BRITISH NORM DOUBLE HIGH TYPE SOCKET BASE	94	pcs.
001 166 000001 00 00	FLUSH MOUNTED SWITCH CASIGN (SQUARE JUNCTION BOX)	28	pcs.
001 047 050001 00 00	BRITISH TYPE BOX (SINGLE) FOR 170X50 CABLE TRUNKING	-	pcs.
001 047 050002 00 00	BRITISH TYPE BOX (SINGLE) FOR 170X50 CABLE TRUNKING	-	pcs.



COUPLER FITTING



T CORNER



INSIDE CORNER

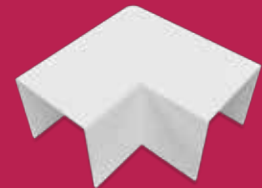

L CORNER



001 046 195100 00 00



NEW

EXTERNAL COVER 100 SERIES PLUG SOCKET ASSEMBLY SETS FOR 100x36 - 100x40 - 100x60

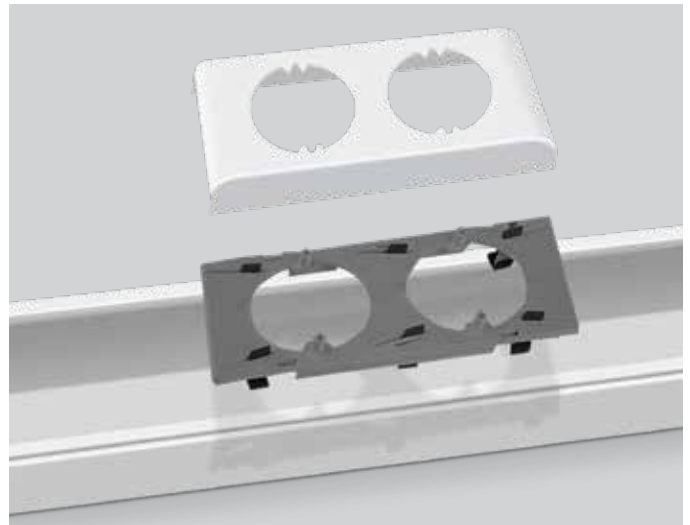
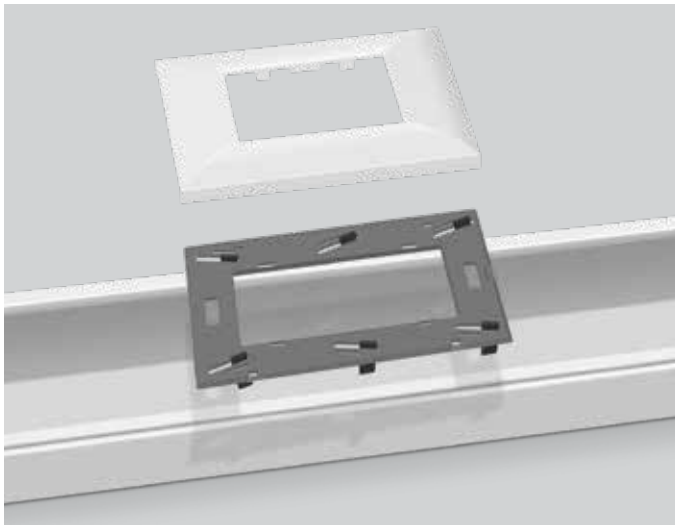

45x45 Single Frame



Code	001 047 040001 00 00
Packing	Box
Quantity	20

55x55 Single Frame



Code	001 047 020001 00 00
Packing	Box
Quantity	20

45x45 Double Frame



Code	001 047 040002 00 00
Packing	Box
Quantity	14

55x55 Double Frame



Code	001 047 020002 00 00
Packing	Box
Quantity	14

45x45 Triple Frame



Code	001 047 040003 00 00
Packing	Box
Quantity	14

55x55 Triple Frame



Code	001 047 020003 00 00
Packing	Box
Quantity	14

45x45 Quartet Frame



Code	001 047 040004 00 00
Packing	Box
Quantity	10



45x22,5
Data Socket Frame
888 049 050012



45x45
Data Socket Cover
888 049 050013



Data Connector
1x8 CAT 6
888 049 050032



Prevents Back Last That Could
Accur in The Trunking
001 050 030004 00 00

MEKSPLUS SERIES INTERNAL COVER CABLE TRUNKING











Protecting Foil

100x37



	EKO Serisi - Series	MEKS Serisi - Series	MEKSPLUS Serisi - Series
Product Code	001 014 100037 20 00	001 002 100037 20 00	001 003 100037 20 00
Packing Type	Box	Box	Box
Quantity / m	30 m	30 m	30 m
Weight	29.067 kg	29.067 kg	29.067 kg
Volume	0.12546	0.12546	0.12546

ACCESSORIES

	Code	Product	Quantity	Weight	Volume
	001 013 100037 00 00	Partition	200 m	19.65 kg	0.054
	001 039 100037 00 00	Internal Corner	12	0.927 kg	0.00984
	001 039 100050 01 00	Internal Corner Live	12	0.696 kg	0.00984
	001 040 100037 00 00	External Corner	8	0.570 kg	0.00984
	001 040 100050 01 00	External Corner Live	10	0.895 kg	0.01011
	001 041 100037 00 00	T Corner	12	0.990 kg	0.01011
	001 042 100037 00 00	90° L Corner	12	0.856 kg	0.00984
	001 043 100050 00 00	Connector	100	1.5 kg	0.01050
	001 044 100037 00 00	Blind Cap	50	0.702 kg	0.00272

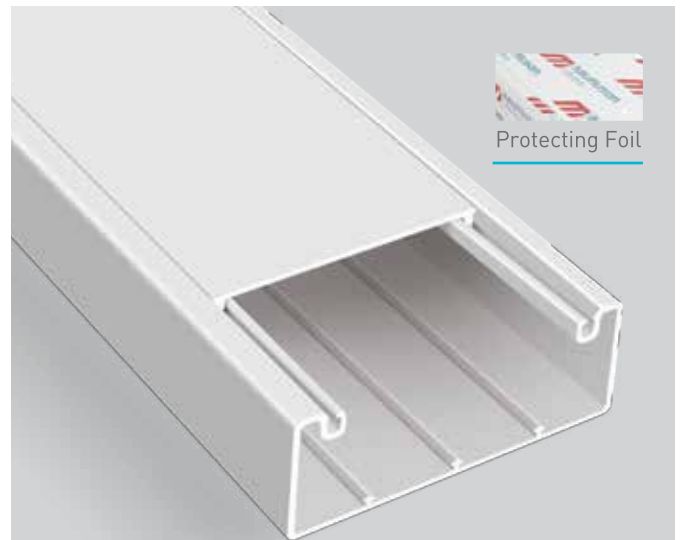







Protecting Foil

100x41



	MEKS Serisi - Series	MEKSPLUS Serisi - Series
Product Code	001 002 100041 20 00	001 003 100041 20 00
Packing Type	Box	Box
Quantity / m	324 m	324 m
Weight	21.918 kg	21.918 kg
Volume	0.12221	0.12221

ACCESSORIES

	Code	Product	Quantity	Weight	Volume
	001 013 100040 20 00	Partition	200 m	21.05 kg	0.054
	001 039 100050 00 00	Internal Corner	8	0.443 kg	0.00984
	001 039 100050 01 00	Internal Corner Live	12	0.847 kg	0.00984
	001 040 100050 00 00	External Corner	8	0.722 kg	0.00984
	001 040 100050 01 00	External Corner Live	10	0.895 kg	0.01011
	001 041 100050 00 00	T Corner	8	0.647 kg	0.00984
	001 042 100050 00 00	90° L Corner	8	0.611 kg	0.00984
	001 043 100050 00 00	Connector	100	1.394 kg	0.01011
	001 044 100050 00 00	Blind Cap	40	0.711 kg	0.00984



Protecting Foil

100x50

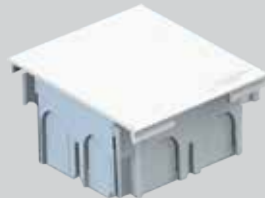
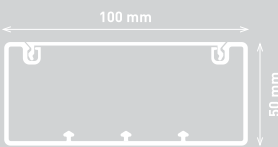

Duct Junction Cube



	CANALEX <small>Serisi - Series</small>	EKO <small>Serisi - Series</small>	MEKS <small>Serisi - Series</small>	MEKSPLUS <small>Serisi - Series</small>
--	--	--	---	---

Product Code	001 156 100050 20 00	001 014 100050 20 00	001 002 100050 20 00	001 003 100050 20 00
Packing Type	Box	Box	Box	Box
Quantity / m	20 m	20 m	20 m	20 m
Weight	17.79 kg	19.37 kg	21.46 kg	22.31 kg
Volume	0.127	0.127	0.127	0.127

ACCESSORIES

Code	Product	Quantity	Weight	Volume
 001 013 100048 20 00	Partition	150 m	19.61 kg	0.075
 001 039 100050 00 00	Internal Corner	8	0.443 kg	0.00984
 001 039 100050 01 00	Internal Corner Live	12	0.847 kg	0.00984
 001 040 100050 00 00	External Corner	8	0.722 kg	0.00984
 001 040 100050 01 00	External Corner Live	10	0.895 kg	0.01011
 001 041 100050 00 00	T Corner	8	0.647 kg	0.00984
 001 042 100050 00 00	90° L Corner	8	0.611 kg	0.00984
 001 043 100050 00 00	Connector	100	1.394 kg	0.01011
 001 044 100050 00 00	Blind Cap	40	0.711 kg	0.00984
 001 043 100050 01 00	Connector (3 set)	100	1.430 kg	0.00987
 001 046 195100 00 00	Duct Junction Cube	25	1.180 kg	0.0086

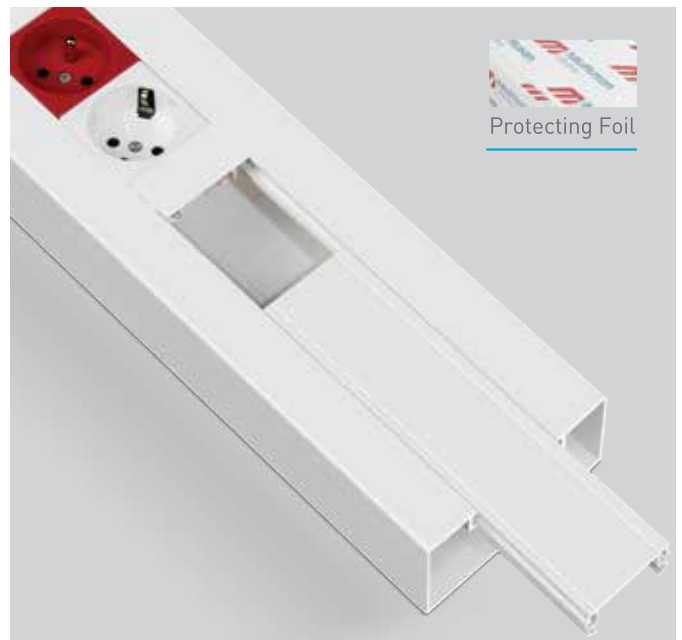

Protecting Foil

100x50

Kaidesiz
Compatible With Mounting
Without Base

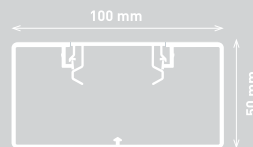

MEKSPLUS Serisi Series

Product Code	001 006 100050 20 00
Packing Type	Box
Quantity / m	20 m
Weight	22.17 kg
Volume / m ³	0.120

ACCESSORIES

Code	Product	Quantity	Weight	Volume
 001 013 100048 20 00	Partition	150 m	19.61 kg	0.075
 001 039 100051 00 00	Internal Corner	8	0.443 kg	0.00984
 001 040 100051 00 00	External Corner	8	0.722 kg	0.00984
 001 041 100051 00 00	T Corner	8	0.647 kg	0.01011
 001 042 100051 00 00	90° L Corner	8	0.611 kg	0.00984
 001 043 100051 00 00	Connector	100	1.394 kg	0.01011
 001 044 100051 00 00	Blind Cap	40	0.711 kg	0.00984
 001 888 100050 00 00	Locking Apparatus	50	-	-

MEKSPLUS CABLE TRUNKING ACCESSORIES FOR 100x37 - 100x41 - 100x50

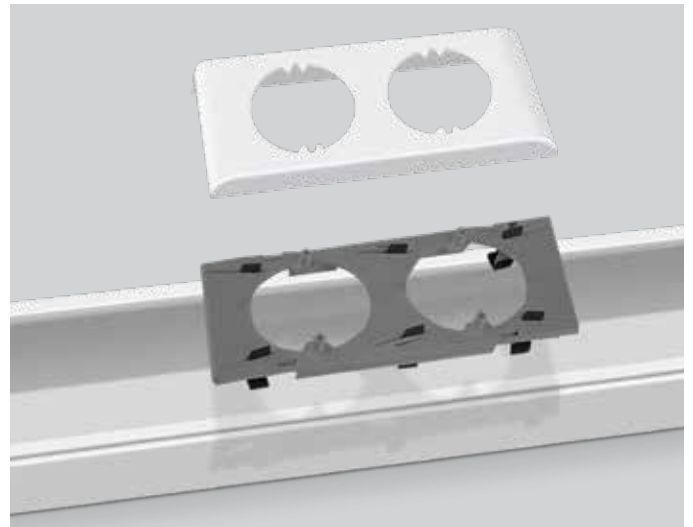
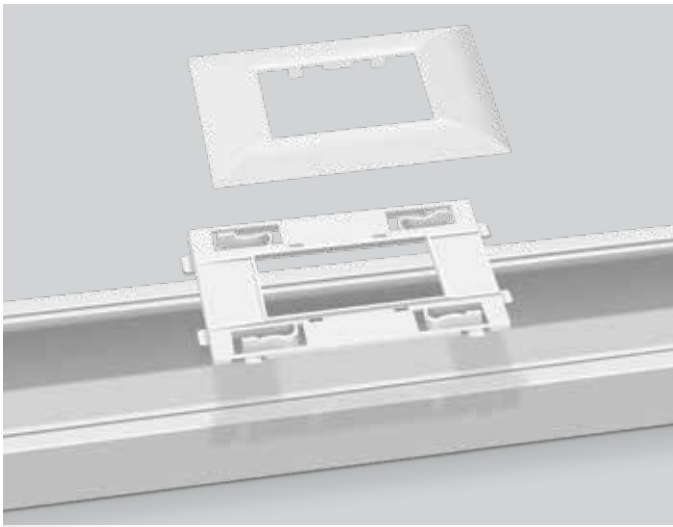

45x45 Single Frame



Code	001 047 070001 00 00
Packing	Box
Quantity	20

55x55 Single Frame



Code	001 047 080001 00 00
Packing	Box
Quantity	20

45x45 Double Frame



Code	001 047 070002 00 00
Packing	Box
Quantity	14
Price	

55x55 Double Frame



Code	001 047 080002 00 00
Packing	Box
Quantity	14

45x45 Triple Frame



Code	001 047 070003 00 00
Packing	Box
Quantity	14

55x55 Triple Frame



Code	001 047 080003 00 00
Packing	Box
Quantity	14

45x45 Quartet Frame



Code	001 047 070004 00 00
Packing	Box
Quantity	10

NEW



UPS AND ENERGY SOCKET FOR TRUNKING (45X45) TSE APPROVED



CODE
001 052 300001 00 00
DESCRIPTION
45X45 EARTED SOCKET
(CHILD PROTECT)(45
DEGREE)
AMBALAJ ADET / KOLİ
50/300



CODE
001 052 300002 00 00
DESCRIPTION
45X45 EARTED SOCKET
UPS (CHILD PROTECT)(45
DEGREE)
AMBALAJ ADET / KOLİ
50/300

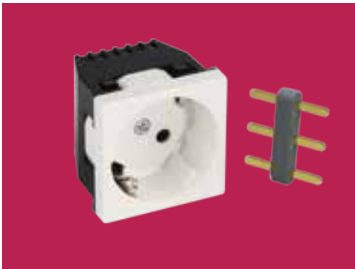

CODE
001 052 200003 00 00
DESCRIPTION
45X45 PRİZ 45X45
SOCKET UNITING TOOL
(SIDE)(NEW)
AMBALAJ ADET / KOLİ
500/5000



CODE
001 052 200005 00 00
DESCRIPTION
45X45 SOCKET UNITING
TOOL
AMBALAJ ADET / KOLİ
50/500



CODE
888 049 050040
DESCRIPTION
SINGLE CONTROL
SWITCH 45X22,5
PACKAGE
10/400



CODE
888 049 050043
DESCRIPTION
DOUBLE CONTROL
SWITCH 45X22,5
PACKAGE
10/400

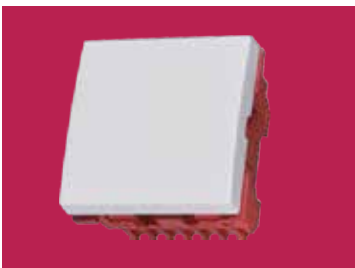

CODE
888 049 050063
DESCRIPTION
SINGLE SWITCH 45X45
PACKAGE
25/250



CODE
888 049 050044
DESCRIPTION
LIGHT SWITCH 45X45
PACKAGE
25/250

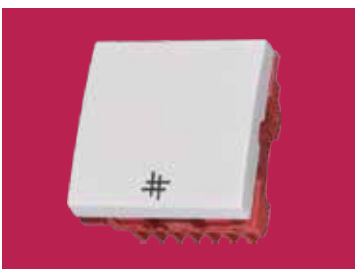

CODE
888 049 050064
DESCRIPTION
4 WAY SWITCH 45X45
PACKAGE
25/250

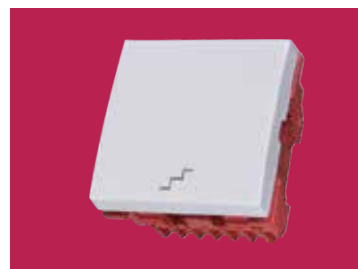

CODE
888 049 050065
DESCRIPTION
STAIRCASE SWITCH
45X45
PACKAGE
25/250



UPS AND ENERGY SOCKET FOR TRUNKING (45X45) TSE APPROVED



CODE
888 049 050042
DESCRIPTION
2 GANG SWITCH 45X45
PACKAGE
25/250



CODE
888 049 050041
DESCRIPTION
MULTI FUNCTION
SOCKET
PACKAGE
10/200



CODE
888 049 050058
DESCRIPTION
45X22,5 USB DATA 90°
PACKAGE
50/500



CODE
888 049 050059
DESCRIPTION
45X22,5 USB DATA 180°
PACKAGE
50/500



CODE
888 049 050046
DESCRIPTION
45X22,5 HDMI
PACKAGE
50/500



CODE
888 049 050047
DESCRIPTION
45X22,5 VGA DATA
JACK
PACKAGE
50/500



CODE
888 049 050056
DESCRIPTION
45X22,5 TV MALE
SOCKET
PACKAGE
50/500



CODE
888 049 050057
DESCRIPTION
45X22,5 TV FEMALE
SOCKET
PACKAGE
50/500



CODE
888 049 050049
DESCRIPTION
45X22,5 RCA
PACKAGE
50/500



CODE
888 049 050060
DESCRIPTION
45X22,5 MINI JACK 3,5
MM STERIO
PACKAGE
50/500



UPS AND ENERGY SOCKET FOR TRUNKING (45X45) TSE APPROVED



CODE
888 049 050051
DESCRIPTION
BLIND 45X22,5
PACKAGE
500/1000



CODE
888 049 050012
DESCRIPTION
45X22,5 WITH SHUTTER
PACKAGE
100/1000



CODE
888 049 050055
DESCRIPTION
BLIND 45X45
PACKAGE
500/1000



CODE
888 049 050013
DESCRIPTION
45X45 WITH SHUTTER
PACKAGE
250/500



CODE
888 049 050061
DESCRIPTION
USB CHARGER 1 PORT
5V 2,1A
PACKAGE
10/200



CODE
888 049 050062
DESCRIPTION
USB CHARGER 2 PORT
5V 2,1A
PACKAGE
10/200



CODE
888 049 050066
DESCRIPTION
KEYSTONE JACK USB
DATA 2,0A
PACKAGE
100/1000



CODE
888 049 050067
DESCRIPTION
KEYSTONE JACK USB
DATA 3,0A
PACKAGE
100/1000



CODE
888 049 050068
DESCRIPTION
KEYSTONE JACK HDMI
PACKAGE
50/500



CODE
888 049 050008
DESCRIPTION
DATA CONNECTOR (1X8)
CAT5
AMBALAJ ADET / KOLİ
10



CODE
888 049 050032
DESCRIPTION
DATA CONNECTOR (1X8)
CAT6
AMBALAJ ADET / KOLİ
10



CODE
888 049 050009
DESCRIPTION
TEL.CONNECTOR (1X4)
CAT3
AMBALAJ ADET / KOLİ
10

NEW



CODE
075 171 222508
DESCRIPTION
14 MOD. DÖŞ. ALTI PRİZ
S.(BOŞ) 221X255
PACKAGE
1



CODE
075 171 333308
DESCRIPTION
14 MOD. DÖŞ. ALTI PRİZ
S.BUAT 330X330
PACKAGE
1



CABLE COLLECTION SPIRAL

888 020 900003	R1035 16 MM CABLE COL. SPIRAL(1,5M VAK)	1 pcs.	40
888 020 900006	R1035 22 MM CABLE COL. SPIRAL(1,5M VAK)	1 pcs.	40
888 020 900009	R1036 28 MM CABLE COL. SPIRAL(1,5M VAK)	1 pcs.	40
888 020 900001	R1033 10 MM CABLE COL. SPIRAL (25M ROLL)	1 mt.	50
888 020 900004	R1034 16 MM CABLE COL. SPIRAL (25M ROLL)	1 mt.	25
888 020 900007	R1035 22 MM CABLE COL. SPIRAL (25M ROLL)	1 mt.	25
888 020 900010	R1036 28 MM CABLE COL. SPIRAL (25M ROLL)	1 mt.	25
888 020 900011	R1037 34 MM CABLE COL.SPIRAL (25M ROLL)	1 mt.	25



CABLE BACKBONE TRUNKING

888 020 200801	CABLE BACKBONE TRUNKING (WHITE)	1 pcs.
888 020 200802	CABLE BACKBONE TRUNKING (GREY)	1 pcs.
888 020 200803	CABLE BACKBONE TRUNKING (BLACK)	1 pcs.

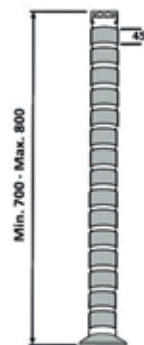

	Code	Product Description	Number of Box	Quantity of Pack	
 <p>BLACK MUT - 11</p>	SİDEM SERIES COLOURED CABLE TRUNKINGS				
	001 007 010008 20 XX	10X8 CABLE TRUNKING SIDEM	330	mt.	
	001 007 012012 20 XX	12X12 CABLE TRUNKING SIDEM	250	mt.	
	001 007 015010 20 XX	15X10 CABLE TRUNKING SIDEM	250	mt.	
	001 007 016016 20 XX	16X16 CABLE TRUNKING SIDEM	250	mt.	
	001 007 020010 20 XX	20X10 CABLE TRUNKING SIDEM	200	mt.	
	001 007 025016 20 XX	25X16 CABLE TRUNKING SIDEM	150	mt.	
	001 007 025025 20 XX	25X25 CABLE TRUNKING SIDEM	100	mt.	
	001 007 930010 20 XX	30X10 CABLE TRUNKING (SEP.) SIDEM	140	mt.	
	001 007 930016 20 XX	30X16 CABLE TRUNKING (SEP.) SIDEM	140	mt.	
	001 007 030025 20 XX	30X25 CABLE TRUNKING SIDEM	80	mt.	
	001 007 040016 20 XX	40X16 CABLE TRUNKING SIDEM	100	mt.	
	001 007 940016 20 XX	40X16 CABLE TRUNKING (SEP.) SIDEM	100	mt.	
	001 007 040025 20 XX	40X25 CABLE TRUNKING SIDEM	80	mt.	
	001 007 040040 20 XX	40X40 CABLE TRUNKING SIDEM	50	mt.	
	001 007 960025 20 XX	60X25 CABLE TRUNKING (SEP.) SIDEM	40	mt.	
	001 007 060040 20 XX	60X40 CABLE TRUNKING SIDEM	40	mt.	
	001 007 060060 20 XX	60X60 CABLE TRUNKING SIDEM	32	mt.	
	001 007 080040 20 XX	80X40 CABLE TRUNKING SIDEM	30	mt.	
	 <p>SILVER MUT - 56</p>	001 007 080060 20 XX	80X60 CABLE TRUNKING SIDEM	24	mt.
001 007 100036 20 XX		100X36 CABLE TRUNKING SIDEM	30	mt.	
001 007 100040 20 XX		100X40 CABLE TRUNKING SIDEM	24	mt.	
001 007 100048 20 XX		100X48 CABLE TRUNKING SIDEM	24	mt.	
001 007 100060 20 XX		100X60 CABLE TRUNKING SIDEM	20	mt.	
001 007 075060 20 XX		75X60 CABLE TRUNKING SIDEM	30	mt.	
001 007 100037 20 XX		100X37 CABLE TRUNKIN IN. LID SIDEM	30	mt.	
001 007 100050 20 XX		100X50 CABLE TRUNKIN IN. LID SIDEM	20	mt.	
001 007 120060 20 XX		120X60 CABLE TRUNKIN IN. LID SIDEM	16	mt.	
001 007 120070 20 XX		120X70 CABLE TRUNKING SIDEM	16	mt.	
001 007 170070 20 XX		170X70 CABLE TRUNKING SIDEM	12	mt.	
 <p>PEAR MUT - 01</p>		SİDEM SERIES COLOURED CABLE TRUNKINGS (ADHESIVE)			
	001 155 010008 20 XX	10X8 CABLE TRUNKING (ADHESIVE) SIDEM	330	mt.	
	001 155 012012 20 XX	12X12 CABLE TRUNKING (ADHESIVE) SIDEM	250	mt.	
	001 155 015010 20 XX	15X10 CABLE TRUNKING (ADHESIVE) SIDEM	250	mt.	
	001 155 016016 20 XX	16X16 CABLE TRUNKING (ADHESIVE) SIDEM	240	mt.	
	001 155 020010 20 XX	20X10 CABLE TRUNKING (ADHESIVE) SIDEM	180	mt.	
	001 155 025016 20 XX	25X16 CABLE TRUNKING (ADHESIVE) SIDEM	150	mt.	
	001 155 025025 20 XX	25X25 CABLE TRUNKING (ADHESIVE) SIDEM	100	mt.	
	001 155 930010 20 XX	30X10 CABLE TRUNKING (ADHESIVE) SIDEM	140	mt.	
	001 155 930016 20 XX	30X16 CABLE TRUNKING (ADHESIVE) SIDEM	140	mt.	
	001 155 030025 20 XX	30X25 CABLE TRUNKING (ADHESIVE) SIDEM	80	mt.	
	001 155 040016 20 XX	40X16 CABLE TRUNKING (ADHESIVE) SIDEM	100	mt.	
	001 155 040025 20 XX	40X25 CABLE TRUNKING (ADHESIVE) SIDEM	80	mt.	
	001 155 040040 20 XX	40X40 CABLE TRUNKING (ADHESIVE) SIDEM	50	mt.	
	001 155 960025 20 XX	60X25 CABLE TRUNKING (ADHESIVE) SIDEM	40	mt.	
	 <p>RIBBED BEIGE MUT - 51</p>	SİDEM SERIES BASEBOARDS AND ACCESSORIES			
		001 007 974020 20 XX	74X20 CABLE TRUNKING (SEP.) SIDEM	50	mt.
	 <p>MERBAU MUT - 02</p>	001 007 975022 20 XX	75X22 CABLE TRUNKING (SEP.) SIDEM	50	mt.
		SİDEM SERIES SKIRTING AND ACCESSORIES			
	 <p>SCARLET BROWN MUT - 52</p>	001 007 050013 20 XX	50X13 CABLE TRUNKING (FLOOR) SIDEM	60	mt.
001 007 060015 20 XX		60X15 CABLE TRUNKING (FLOOR) SIDEM	40	mt.	
001 031 060015 00 XX		60X15 L CORNER(FLOOR) SIDEM	1	pcs.	
001 032 060015 00 XX		60X15 COUPLER FITTING (FLOOR) SIDEM	1	pcs.	
001 033 060015 00 XX		60X15 END CUPAK (FLOOR) SIDEM	1	pcs.	
001 030 060015 00 XX		60X15 T CORNER (FLOOR) SIDEM	1	pcs.	
001 007 075018 20 XX		75X18 CABLE TRUNKING (FLOOR) SIDEM	30	mt.	
001 007 090020 20 XX		90X20 CABLE TRUNKING (FLOOR)SIDEM	20	mt.	
 <p>DARK WALNUT MUT - 03</p>		SİDEM SERIES COLOURED CABLE TRUNKINGS (ADHESIVE)			
		001 155 050013 20 XX	50X13 CABLE TRUNKING (ADHESIVE) SIDEM	60	mt.
	001 155 060015 20 XX	60X15 CABLE TRUNKING (ADHESIVE) SIDEM	80	mt.	
	001 155 075018 20 XX	75X18 CABLE TRUNKING (ADHESIVE) SIDEM	60	mt.	
 <p>RIBBED BROWN MUT - 53</p>	001 155 060040 20 XX	60X40 CABLE TRUNKING (ADHESIVE) SIDEM	40	mt.	
	12X12 TRUNKING ACCESSORIES (SİDEM SERIES)				
 <p>LIGHT BEECH MUT - 04</p>	001 028 012012 00 XX	12X12 INSIDE CORNER SIDEM	1	pcs.	
	001 029 012012 00 XX	12X12 OUTSIDE CORNER SIDEM	1	pcs.	
	001 030 012012 00 XX	12X12 T CORNER SIDEM	1	pcs.	
	001 031 012012 00 XX	12X12 L CORNER SIDEM	1	pcs.	
	001 033 012012 00 XX	12X12 END CUP SIDEM	1	pcs.	
	001 032 012012 00 XX	12X12 COUPLER FITTING SIDEM	1	pcs.	
	 <p>RIBBED LIGHT BEIGE MUT - 54</p>	15X10 TRUNKING ACCESSORIES (SİDEM SERIES)			
001 028 015010 00 XX		15X10 INSIDE CORNER SIDEM	1	pcs.	
001 029 015010 00 XX		15X10 OUTSIDE CORNER SIDEM	1	pcs.	
001 030 015010 00 XX		15X10 T CORNER SIDEM	1	pcs.	
001 031 015010 00 XX		15X10 L CORNER SIDEM	1	pcs.	
001 033 015010 00 XX		15X10 END CUP SIDEM	1	pcs.	
 <p>MAHOGANY MUT - 05</p>	001 032 015010 00 XX	15X10 COUPLER FITTING SIDEM	1	pcs.	
	15X10 TRUNKING ACCESSORIES (SİDEM SERIES)				
 <p>RIBBED SCARLET MUT - 55</p>	001 028 015010 00 XX	15X10 INSIDE CORNER SIDEM	1	pcs.	
	001 029 015010 00 XX	15X10 OUTSIDE CORNER SIDEM	1	pcs.	
	001 030 015010 00 XX	15X10 T CORNER SIDEM	1	pcs.	
	001 031 015010 00 XX	15X10 L CORNER SIDEM	1	pcs.	
	001 033 015010 00 XX	15X10 END CUP SIDEM	1	pcs.	
	001 032 015010 00 XX	15X10 COUPLER FITTING SIDEM	1	pcs.	

Code	Product Description	Number of Box	Quantity of Pack
16X16 TRUNKING ACCESSORIES (SİDEM SERIES)			
001 028 016016 00 XX	16X16 INSIDE CORNER SIDEM	1	pcs.
001 029 016016 00 XX	16X16 OUTSIDE CORNER SIDEM	1	pcs.
001 030 016016 00 XX	16X16 T CORNER SIDEM	1	pcs.
001 031 016016 00 XX	16X16 L CORNER SIDEM	1	pcs.
001 033 016016 00 XX	16X16 END CUP SIDEM	1	pcs.
001 032 016016 00 XX	16X16 COUPLER FITTING SIDEM	1	pcs.
20X10 TRUNKING ACCESSORIES (SİDEM SERIES)			
001 028 020010 00 XX	20X10 INSIDE CORNER SIDEM	1	pcs.
001 029 020010 00 XX	20X10 OUTSIDE CORNER SIDEM	1	pcs.
001 030 020010 00 XX	20X10 T CORNER SIDEM	1	pcs.
001 031 020010 00 XX	20X10 L CORNER SIDEM	1	pcs.
001 033 020010 00 XX	20X10 END CUP SIDEM	1	pcs.
001 032 020010 00 XX	20X10 COUPLER FITTING SIDEM	1	pcs.
CEILING CORNER TRUNKING & ACCESSORIES (SİDEM MERIES)			
001 041 023023 00 XX	23X23 T CORNER SIDEM	1	pcs.
001 042 023023 00 XX	23X23 L CORNER SIDEM	1	pcs.
001 043 023023 00 XX	23X23 COUPLER FITTING SIDEM	1	pcs.
001 044 023023 00 XX	23X23 END CUP SIDEM	1	pcs.
25X16 TRUNKING ACCESSORIES (SİDEM SERIES)			
001 028 025016 00 XX	25X16 INSIDE CORNER SIDEM	1	pcs.
001 029 025016 00 XX	25X16 OUTSIDE CORNER SIDEM	1	pcs.
001 030 025016 00 XX	25X16 T CORNER SIDEM	1	pcs.
001 031 025016 00 XX	25X16 L CORNER SIDEM	1	pcs.
001 033 025016 00 XX	25X16 END CUP SIDEM	1	pcs.
001 032 025016 00 XX	25X16 COUPLER FITTING SIDEM	1	pcs.
001 034 017421 00 XX	SOM FRAME(74X20)(45X45) SIDEM	1	pcs.
25X25 TRUNKING ACCESSORIES (SİDEM SERIES)			
001 028 025025 00 XX	25X25 INSIDE CORNER SIDEM	1	pcs.
001 029 025025 00 XX	25X25 OUTSIDE CORNER SIDEM	1	pcs.
001 030 025025 00 XX	25X25 T CORNER SIDEM	1	pcs.
001 031 025025 00 XX	25X25 L CORNER SIDEM	1	pcs.
001 033 025025 00 XX	25X25 END CUP SIDEM	1	pcs.
001 032 025025 00 XX	25X25 COUPLER FITTING SIDEM	1	pcs.
001 034 017421 00 XX	SOM FRAME(74X20)(45X45) SIDEM	1	pcs.
30X10 TRUNKING ACCESSORIES (SİDEM SERIES)			
001 028 030010 00 XX	30X10 INSIDE CORNER SIDEM	1	pcs.
001 029 030010 00 XX	30X10 OUTSIDE CORNER SIDEM	1	pcs.
001 030 030010 00 XX	30X10 T CORNER SIDEM	1	pcs.
001 031 030010 00 XX	30X10 L CORNER SIDEM	1	pcs.
001 033 030010 00 XX	30X10 END CUP SIDEM	1	pcs.
001 032 030010 00 XX	30X10 COUPLER FITTING SIDEM	1	ad
30X16 TRUNKING ACCESSORIES (SİDEM SERIES)			
001 028 030016 00 XX	30X16 INSIDE CORNER SIDEM	1	pcs.
001 029 030016 00 XX	30X16 OUTSIDE CORNER SIDEM	1	pcs.
001 030 030016 00 XX	30X16 T CORNER SIDEM	1	pcs.
001 031 030016 00 XX	30X16 L CORNER SIDEM	1	pcs.
001 033 030016 00 XX	30X16 END CUP SIDEM	1	pcs.
001 032 030016 00 XX	30X16 COUPLER FITTING SIDEM	1	pcs.
30X25 TRUNKING ACCESSORIES (SİDEM SERIES)			
001 028 030025 00 XX	30X25 INSIDE CORNER SIDEM	1	pcs.
001 029 030025 00 XX	30X25 OUTSIDE CORNER SIDEM	1	pcs.
001 030 030025 00 XX	30X25 T CORNER SIDEM	1	pcs.
001 031 030025 00 XX	30X25 L CORNER SIDEM	1	pcs.
001 033 030025 00 XX	30X25 END CUP SIDEM	1	pcs.
001 032 030025 00 XX	30X25 COUPLER FITTING SIDEM	1	pcs.
40X16 TRUNKING ACCESSORIES (SİDEM SERIES)			
001 028 040016 00 XX	40X16 INSIDE CORNER SIDEM	1	pcs.
001 029 040016 00 XX	40X16 OUTSIDE CORNER SIDEM	1	pcs.
001 030 040016 00 XX	40X16 T CORNER SIDEM	1	pcs.
001 031 040016 00 XX	40X16 L CORNER SIDEM	1	pcs.
001 033 040016 00 XX	40X16 END CUP SIDEM	1	pcs.
001 032 040016 00 XX	40X16 COUPLER FITTING SIDEM	1	pcs.
001 034 017421 00 XX	SOM FRAME(74X20)(45X45) SIDEM	1	pcs.
40X25 TRUNKING ACCESSORIES (SİDEM SERIES)			
001 028 040025 00 XX	40X25 INSIDE CORNER SIDEM	1	pcs.
001 029 040025 00 XX	40X25 OUTSIDE CORNER SIDEM	1	pcs.
001 030 040025 00 XX	40X25 T CORNER SIDEM	1	pcs.
001 031 040025 00 XX	40X25 L CORNER SIDEM	1	pcs.
001 033 040025 00 XX	40X25 END CUP SIDEM	1	pcs.
001 032 040025 00 XX	40X25 COUPLER FITTING SIDEM	1	pcs.
001 034 017421 00 XX	SOM FRAME(74X20)(45X45) SIDEM	1	pcs.



L CORNER









COUPLER FITTING



END CUP



	Code	Product Description	Number of Box	Quantity of Pack
 <p>INSIDE CORNER</p>	40X40 TRUNKING ACCESSORIES (SİDEM SERIES)			
	001 028 040040 00 XX	40X40 INSIDE CORNER SIDEM	1	pcs.
	001 029 040040 00 XX	40X40 OUTSIDE CORNER SIDEM	1	pcs.
	001 030 040040 00 XX	40X40 T CORNER SIDEM	1	pcs.
	001 031 040040 00 XX	40X40 L CORNER SIDEM	1	pcs.
	001 033 040040 00 XX	40X40 END CUP SIDEM	1	pcs.
	001 032 040040 00 XX	40X40 COUPLER FITTING SIDEM	1	pcs.
 <p>OUTSIDE CORNER</p>	60X25 TRUNKING ACCESSORIES (SİDEM SERIES)			
	001 028 060025 00 XX	60X25 INSIDE CORNER SIDEM	1	pcs.
	001 029 060025 00 XX	60X25 OUTSIDE CORNER SIDEM	1	pcs.
	001 030 060025 00 XX	60X25 T CORNER SIDEM	1	pcs.
	001 031 060025 00 XX	60X25 L CORNER SIDEM	1	pcs.
	001 033 060025 00 XX	60X25 END CUP SIDEM	1	pcs.
	001 032 060025 00 XX	60X25 COUPLER FITTING SIDEM	1	pcs.
 <p>T CORNER</p>	60X40 TRUNKING ACCESSORIES (SİDEM SERIES)			
	001 028 060040 00 XX	60X40 INSIDE CORNER SIDEM	1	pcs.
	001 029 060040 00 XX	60X40 OUTSIDE CORNER SIDEM	1	pcs.
	001 030 060040 00 XX	60X40 T CORNER SIDEM	1	pcs.
	001 031 060040 00 XX	60X40 L CORNER SIDEM	1	pcs.
	001 033 060040 00 XX	60X40 END CUP SIDEM	1	pcs.
	001 032 060040 00 XX	60X40 COUPLER FITTING SIDEM	1	pcs.
 <p>L CORNER</p>	60X60 TRUNKING ACCESSORIES (SİDEM SERIES)			
	001 028 060060 00 XX	60X60 INSIDE CORNER SIDEM	1	pcs.
	001 029 060060 00 XX	60X60 OUTSIDE CORNER SIDEM	1	pcs.
	001 030 060060 00 XX	60X60 T CORNER SIDEM	1	pcs.
	001 031 060060 00 XX	60X60 L CORNER SIDEM	1	pcs.
	001 033 060060 00 XX	60X60 END CUP SIDEM	1	pcs.
	001 032 060060 00 XX	60X60 COUPLER FITTING SIDEM	1	pcs.
 <p>COUPLER FITTING</p>	74X20 TRUNKING ACCESSORIES (SİDEM SERIES)			
	001 028 074020 00 XX	74X20 INSIDE CORNER SIDEM	1	pcs.
	001 029 074020 00 XX	74X20 OUTSIDE CORNER SIDEM	1	pcs.
	001 030 074020 00 XX	74X20 T CORNER SIDEM	1	pcs.
	001 031 074020 00 XX	74X20 L CORNER SIDEM	1	pcs.
	001 032 074020 00 XX	74X20 END CUP SIDEM	1	pcs.
	001 033 074020 00 XX	74X20 COUPLER FITTING SIDEM	1	pcs.
 <p>END CUP</p>	75X22 TRUNKING ACCESSORIES (SİDEM SERIES)			
	001 028 075022 00 XX	75X22 INSIDE CORNERSIDEM	1	pcs.
	001 029 075022 00 XX	75X22 OUTSIDE CORNER SIDEM	1	pcs.
	001 033 075022 01 XX	75X22 RIGHT END CUPSIDEM	1	pcs.
	001 033 075022 02 XX	75X22 LEFT END CUPSIDEM	1	pcs.
	001 032 075022 00 XX	75X22 COUPLER FITTINGSIDEM	1	pcs.
	80X40 TRUNKING ACCESSORIES (SİDEM SERIES)			
001 028 080040 00 XX	80X40 INSIDE CORNER SIDEM	1	pcs.	
001 029 080040 00 XX	80X40 OUTSIDE CORNER SIDEM	1	pcs.	
001 030 080040 00 XX	80X40 T CORNER SIDEM	1	pcs.	
001 031 080040 00 XX	80X40 L CORNER SIDEM	1	pcs.	
001 033 080040 00 XX	80X40 END CUP SIDEM	1	pcs.	
001 032 080040 00 XX	80X40 COUPLER FITTING SIDEM	1	pcs.	
80X60 TRUNKING ACCESSORIES (SİDEM SERIES)				
001 028 080060 00 XX	80X60 INSIDE CORNER SIDEM	1	pcs.	
001 029 080060 00 XX	80X60 OUTSIDE CORNER SIDEM	1	pcs.	
001 030 080060 00 XX	80X60 T CORNER SIDEM	1	pcs.	
001 031 080060 00 XX	80X60 L CORNER SIDEM	1	pcs.	
001 033 080060 00 XX	80X60 END CUP SIDEM	1	pcs.	
001 032 080060 00 XX	80X60 COUPLER FITTING SIDEM	1	pcs.	
100X36 TRUNKING ACCESSORIES (SİDEM SERIES)				
001 028 100036 00 XX	100X36 INSIDE CORNER (FIXED) SIDEM	1	pcs.	
001 029 100036 00 XX	100X36 OUTSIDE CORNER (FIXED) SIDEM	1	pcs.	
001 028 100036 01 XX	100X36 INSIDE CORNER (MOVING) SIDEM	1	pcs.	
001 029 100036 01 XX	100X36 OUTSIDE CORNER (MOVING)SIDEM	1	pcs.	
001 030 100036 00 XX	100X36 T CORNER SIDEM	1	pcs.	
001 031 100036 00 XX	100X36 L CORNER SIDEM	1	pcs.	
001 033 100036 00 XX	100X36 END CUP SIDEM	1	pcs.	
001 032 100036 00 XX	100X36 COUPLER FITTING SIDEM	1	pcs.	

Code	Product Description	Number of Box	Quantity of Pack
100X37 TRUNKING ACCESSORIES (SIDEM SERIES)			
001 028 100037 00 XX	100X37 INSIDE CORNER (FIXED) SIDEM	1	pcs.
001 029 100037 00 XX	100X37 OUTSIDE CORNER (FIXED) SIDEM	1	pcs.
001 028 100037 01 XX	100X37 INSIDE CORNER (MOVING) SIDEM	1	pcs.
001 029 100037 01 XX	100X37 OUTSIDE CORNER (MOVING) SIDEM	1	pcs.
001 030 100037 00 XX	100X37 T CORNER SIDEM	1	pcs.
001 031 100037 00 XX	100X37 L CORNER SIDEM	1	pcs.
001 033 100037 00 XX	100X37 END CUP SIDEM	1	pcs.
001 032 100037 00 XX	100X37 COUPLER FITTING SIDEM	1	pcs.
100X40 TRUNKING ACCESSORIES (SIDEM SERIES)			
001 028 100040 00 XX	100X40 INSIDE CORNER (FIXED) SIDEM	1	pcs.
001 029 100040 00 XX	100X40 OUTSIDE CORNER (FIXED) SIDEM	1	pcs.
001 028 100040 01 XX	100X40 INSIDE CORNER (MOVING) SIDEM	1	pcs.
001 029 100040 01 XX	100X40 OUTSIDE CORNER (MOVING) SIDEM	1	pcs.
001 030 100040 00 XX	100X40 T CORNER SIDEM	1	pcs.
001 031 100040 00 XX	100X40 L CORNER SIDEM	1	pcs.
001 033 100040 00 XX	100X40 END CUP SIDEM	1	pcs.
001 032 100040 00 XX	100X40 COUPLER FITTING SIDEM	1	pcs.
100X48 TRUNKING ACCESSORIES (SIDEM SERIES)			
001 028 100048 00 XX	100X48 INSIDE CORNER (FIXED) SIDEM	1	pcs.
001 029 100048 00 XX	100X48 OUTSIDE CORNER (FIXED) SIDEM	1	pcs.
001 028 100048 01 XX	100X48 INSIDE CORNER (MOVING) SIDEM	1	pcs.
001 029 100048 01 XX	100X48 OUTSIDE CORNER (MOVING) SIDEM	1	pcs.
001 030 100048 00 XX	100X48 T CORNER SIDEM	1	pcs.
001 031 100048 00 XX	100X48 L CORNER SIDEM	1	pcs.
001 033 100048 00 XX	100X48 END CUP SIDEM	1	pcs.
001 032 100048 00 XX	100X48 COUPLER FITTING SIDEM	1	pcs.
100X50 TRUNKING ACCESSORIES (SIDEM SERIES)			
001 028 100050 00 XX	100X50 INSIDE CORNER (FIXED) SIDEM	1	pcs.
001 029 100050 00 XX	100X50 OUTSIDE CORNER (FIXED) SIDEM	1	pcs.
001 028 100050 01 XX	100X50 INSIDE CORNER (MOVING) SIDEM	1	pcs.
001 029 100050 01 XX	100X50 OUTSIDE CORNER (MOVING) SIDEM	1	pcs.
001 030 100050 00 XX	100X50 T CORNER SIDEM	1	pcs.
001 031 100050 00 XX	100X50 L CORNER SIDEM	1	pcs.
001 033 100050 00 XX	100X50 END CUP SIDEM	1	pcs.
001 032 100050 00 XX	100X50 COUPLER FITTING SIDEM	1	pcs.
100X60 TRUNKING ACCESSORIES (SIDEM SERIES)			
001 028 100060 00 XX	100X60 INSIDE CORNER (FIXED) SIDEM	1	pcs.
001 029 100060 00 XX	100X60 OUTSIDE CORNER (FIXED) SIDEM	1	pcs.
001 028 100060 01 XX	100X60 INSIDE CORNER (MOVING) SIDEM	1	pcs.
001 029 100060 01 XX	100X60 OUTSIDE CORNER (MOVING) SIDEM	1	pcs.
001 030 100060 00 XX	100X60 T CORNER SIDEM	1	pcs.
001 031 100060 00 XX	100X60 L CORNER SIDEM	1	pcs.
001 033 100060 00 XX	100X60 END CUP SIDEM	1	pcs.
001 032 100060 00 XX	100X60 COUPLER FITTING SIDEM	1	pcs.
FOR 100X37/50 TRUNKING ACCESSORIES (SIDEM SERIES)			
001 034 400001 00 XX	SOM SET(100X37/50)(45X45)(1) SIDEM	1	pcs.
001 034 400002 00 XX	SOM SET(100X37/50)(45X45)(2) SIDEM	1	pcs.
001 034 400003 00 XX	SOM SET(100X37/50)(45X45)(3) SIDEM	1	pcs.
001 034 400004 00 XX	SOM SET(100X37/50)(45X45)(4) SIDEM	1	pcs.
001 034 500001 00 XX	SOM SET(100X37/50)(55X55)(1) SIDEM	1	pcs.
001 034 500002 00 XX	SOM SET(100X37/50)(55X55)(2) SIDEM	1	pcs.
001 034 500003 00 XX	SOM SET(100X37/50)(55X55)(3)SIDEM	1	pcs.
100.S PMS (FOR 55X55) (SIDEM SERIES)			
001 034 000001 00 XX	100 SERIE 55X55 SWITCH AND SOCKET ASSEMBLY SET 1 GANG	1	pcs.
001 034 000002 00 XX	100 SERIE 55X55 SWITCH AND SOCKET ASSEMBLY SET 2 GANG	1	pcs.
001 034 000003 00 XX	100 SERIE 55X55 SWITCH AND SOCKET ASSEMBLY SET 3 GANG	1	pcs.
100.S SERIES PMS (FOR 45X45) (SIDEM SERIES)			
001 034 100001 00 XX	100 SERIE 45X45 SWITCH AND SOCKET ASSEMBLY SET 1 GANG	1	pcs.
001 034 100002 00 XX	100 SERIE 45X45 SWITCH AND SOCKET ASSEMBLY SET 2 GANG	1	pcs.
001 034 100003 00 XX	100 SERIE 45X45 SWITCH AND SOCKET ASSEMBLY SET 3 GANG	1	pcs.
001 034 100004 00 XX	100 SERIE 45X45 SWITCH AND SOCKET ASSEMBLY SET 4 GANG	1	pcs.



CABLE SPIRALS

ALL SPIRALS ARE HALOGEN FREE

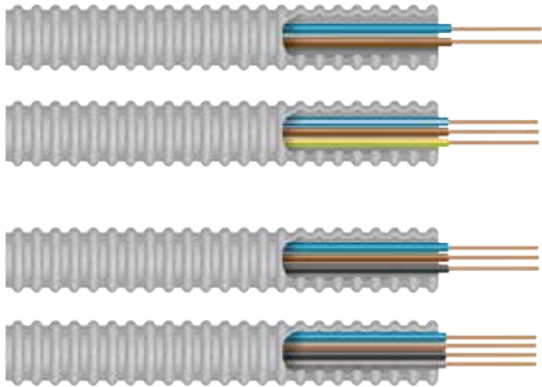

SPIRAL POWER CABLES HALOGEN FREE

Kode	Cable Cross-Section mm ²	Pipe Feoverpressurere	Pipe Diametre (mm)
------	-------------------------------------	-----------------------	--------------------

H07V-U (NYA) ENERGY CABLES HALOGEN FREE

122 051 215014	2x1.5	HF-PE	16
122 051 315014	3x1.5	HF-PE	16
122 051 415016	4x1.5	HF-PE	16
122 051 515020	5x1.5	HF-PE	20
122 051 225014	2x2.5	HF-PE	16
122 051 325014	3x2.5	HF-PE	16
122 051 425016	4x2.5	HF-PE	16
122 051 525025	5x2.5	HF-PE	25



SPIRAL LOW CURRENT CABLES HALOGEN FREE

Kode	Cable Cross-Section mm ²	Pipe Feoverpressurere	Pipe Diametre (mm)
------	-------------------------------------	-----------------------	--------------------

(LSZH) DATA CABLES HALOGEN FREE

122 053 100516	U/UTP CAT5e (4x2x24AWG)	HF-PE	14
122 053 100616	U/UTP CAT6 (4x2x23AWG)	HF-PE	14

(PHY-HF) COAXIAL CABLES HALOGEN FREE

122 053 200416	RG 6 U/4 (Cu/AL)	HF-PE	14
122 053 200616	RG 6 U/6 (Cu/Cu)	HF-PE	14

CCTV CAMERAS CABLES HALOGEN FREE

122 053 301214	1+2 RG 59 Mini (2x0.50 mm ²)	HF-PE	14
122 053 301416	1+4 RG 59 Mini (2x0.50 mm ²) + (2x0.22 mm ²)	HF-PE	14

J-H (st) H FIRE ALARM CABLES HALOGEN FREE

122 053 401216	1x2x0.80 mm ² + 0.80 mm ²	HF-PE	14
122 053 402216	2x2x0.80 mm ² + 0.80 mm ²	HF-PE	14

LIHH DIAPHONAL CABLE HALOGEN FREE

122 053 502216	LIHH 8x0.22 mm ²	HF-PE	14
----------------	-----------------------------	-------	----



CABLE SPIRALS

ALL SPIRALS ARE HALOGEN FREE

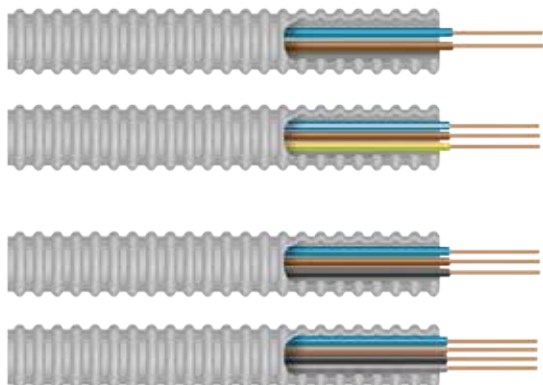

SPIRAL POWER CABLES

Kode	Cable Cross-Section mm ²	Pipe Feoverpressurere	Pipe Diametre (mm)
H07V-U (NYA) ENERGY CABLES			
122 050 215014	2x1.5	HF-PE	16
122 050 315014	3x1.5	HF-PE	16
122 050 415016	4x1.5	HF-PE	16
122 050 515020	5x1.5	HF-PE	20
122 050 225014	2x2.5	HF-PE	16
122 050 325014	3x2.5	HF-PE	16
122 050 425016	4x2.5	HF-PE	16
122 050 525025	5x2.5	HF-PE	25



SPIRAL LOW CURRENT CABLES

Kode	Cable Cross-Section mm ²	Pipe Feoverpressurere	Pipe Diametre (mm)
DATA CABLES			
122 052 100516	U / UTP CAT5e	HF-PE	14
122 052 100616	U / UTP CAT6e	HF-PE	14

COAXIAL CABLES

122 052 200214	RG 59/U2(cu/AL)	HF-PE	14
122 052 200416	RG 6/U4 (cu/AL)	HF-PE	14
122 052 200616	RG 6/U6 (cu/cu)	HF-PE	14

CCTV CAMERAS CABLES

122 052 301214	CCTV 1+2 [2x0.22 mm ²]	HF-PE	14
122 052 301416	CCTV 1+4 [2x2x0.22 mm ²]	HF-PE	14









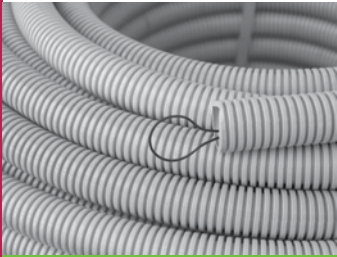
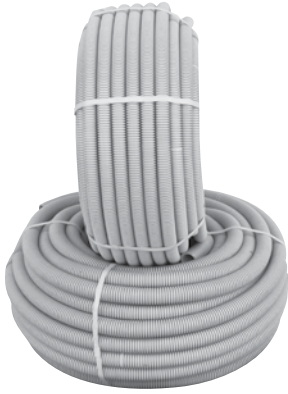













JY (st)Y FIRE ALARM CABLES

122 052 401215	JY(st)Y 1x2x0.80+40 mm ²	HF-PE	14
122 052 402216	JY(st)Y 2x2x0.80+40 mm ²	HF-PE	14

DIAPHONAL CABLE

122 052 502216	DT-8 8x0.22 mm ²	HF-PE	14
----------------	-----------------------------	-------	----



Code	Product Description	Inner Diameter	Outer Diameter	Number of Box	Quantity of Pack
HEAVY SERIES PVC. SPIRALS (FLAME RETARDANT) (750N)					
  					
001 020 000016 00 17	Ø16 NONFLAME SPIRAL(HEAVY DUTY)(GRAY)	11,2	15,85	100 mt.	500
001 020 000020 00 17	Ø20 NONFLAME SPIRAL(HEAVY DUTY)(GRAY)	14,4	19,85	100 mt.	500
001 020 000025 00 17	Ø25 NONFLAME SPIRAL(HEAVY DUTY)(GRAY)	18,1	24,8	50 mt.	250
001 020 000032 00 17	Ø32 NONFLAME SPIRAL(HEAVY DUTY)(GRAY)	24,7	31,8	50 mt.	250
HEAVY SERIES PVC. WIRED SPIRALS (FLAME RETARDANT)(750N)					
  					
001 020 100016 00 17	Ø16 NONFLAME SPIRAL(HEAVY DUTY)(WIRED)(GRAY)	11,2	15,85	100 mt.	500
001 020 100020 00 17	Ø20 NONFLAME SPIRAL(HEAVY DUTY)(WIRED)(GRAY)	14,4	19,85	100 mt.	500
001 020 100025 00 17	Ø25 NONFLAME SPIRAL(HEAVY DUTY)(WIRED)(GRAY)	18,1	24,8	50 mt.	250
001 020 100032 00 17	Ø32 NONFLAME SPIRAL(HEAVY DUTY)(WIRED)(GRAY)	24,7	31,8	50 mt.	250
HALOGEN FREE SPIRALS (FLAME-PROPAGATING)(320N)					
 					
001 020 140016 00 17	Ø16 H.FREE SPIRAL(GRAY)	11,2	15,7	100 mt.	500
001 020 140020 00 17	Ø20 H.FREE SPIRAL(GRAY)	14,4	19,85	100 mt.	500
001 020 140025 00 17	Ø25 H.FREE SPIRAL(GRAY)	19,1	24,7	50 mt.	250
001 020 140032 00 17	Ø32 H.FREE SPIRAL(GRAY)	24,85	31,6	50 mt.	250
001 020 140040 00 17	Ø40 H.FREE SPIRAL(GRAY)			25 mt.	125
001 020 140050 00 17	Ø50 H.FREE SPIRAL(GRAY)			25 mt.	125
HALOGEN FREE SPIRALS (FLAME-PROPAGATING)(750N)					
 					
001 020 740020 00 17	Ø20 H.FREE SPIRAL(GRAY)	14,4	19,85	100 mt.	500
001 020 740025 00 17	Ø25 H.FREE SPIRAL(GRAY)	18,7	24,7	50 mt.	250
001 020 740032 00 17	Ø32 H.FREE SPIRAL(GRAY)	24,2	31,6	50 mt.	250
HALOGEN FREE SPIRALS (FLAME-PROPAGATING)(1250N)					
 					
001 020 240020 00 17	Ø20 H.FREE SPIRAL(GRAY)	14	19,85	100 mt.	500
001 020 240025 00 17	Ø25 H.FREE SPIRAL(GRAY)	18,4	24,7	50 mt.	250
001 020 240032 00 17	Ø32 H.FREE SPIRAL(GRAY)	24	31,6	50 mt.	250
HALOGEN FREE SPIRALS WIRED (FLAME-PROPAGATING)(320N)					
 					
001 020 141016 00 17	Ø16 H.FREE SPIRAL(GRAY) WIRED	11,2	15,7	100 mt.	500
001 020 141020 00 17	Ø20 H.FREE SPIRAL(GRAY) WIRED	14,4	19,85	100 mt.	500
001 020 141025 00 17	Ø25 H.FREE SPIRAL(GRAY) WIRED	19,1	24,7	50 mt.	250
001 020 141032 00 17	Ø32 H.FREE SPIRAL(GRAY) WIRED	24,85	31,6	50 mt.	250
001 020 141040 00 17	Ø40 H.FREE SPIRAL(GRAY) WIRED			25 mt.	125
HALOGEN FREE SPIRALS (FLAME RETARDANT)(320N)					
 					
001 020 150016 00 17	Ø16 H.FREE SPIRAL(NONFLAME)(GRAY)	11,2	15,7	100 mt.	500
001 020 150020 00 17	Ø20 H.FREE SPIRAL(NONFLAME)(GRAY)	14,4	19,85	100 mt.	500
001 020 150025 00 17	Ø25 H.FREE SPIRAL(NONFLAME)(GRAY)	19,1	24,7	50 mt.	250
001 020 150032 00 17	Ø32 H.FREE SPIRAL(NONFLAME)(GRAY)	24,85	31,6	50 mt.	250
001 020 150040 00 17	Ø40 H.FREE SPIRAL(NONFLAME)(GRAY)			25 mt.	125
001 020 150050 00 17	Ø50 H.FREE SPIRAL(NONFLAME)(GRAY)			25 mt.	125
HALOGEN FREE SPIRALS (FLAME RETARDANT)(750N)					
 					
001 020 750020 00 17	Ø20/750N H.FREE SPIRAL(NONFLAME)(GRAY)	14,4	19,85	100 mt.	500
001 020 750025 00 17	Ø25/750N H.FREE SPIRAL(NONFLAME)(GRAY)	18,7	24,7	50 mt.	250
001 020 750032 00 17	Ø32/750N H.FREE SPIRAL(NONFLAME)(GRAY)	24,2	31,6	50 mt.	250
HALOGEN FREE SPIRALS (FLAME RETARDANT)(1250N)					
 					
001 020 250020 00 17	Ø20/1250N H.FREE SPIRAL(NONFLAME)(GRAY)	14	19,85	100 mt.	500
001 020 250025 00 17	Ø25/1250N H.FREE SPIRAL(NONFLAME)(GRAY)	18,4	24,7	50 mt.	250
001 020 250032 00 17	Ø32/1250N H.FREE SPIRAL(NONFLAME)(GRAY)	24	31,6	50 mt.	250
HALOGEN FREE SPIRALS WIRED (FLAME RETARDANT)(320N)					
 					
001 020 151016 00 17	Ø16 H.FREE SPIRAL(NONFLAME)(WIRED)(GRAY)	11,2	15,7	100 mt.	500
001 020 151020 00 17	Ø20 H.FREE SPIRAL(NONFLAME)(WIRED)(GRAY)	14,4	19,85	100 mt.	500
001 020 151025 00 17	Ø25 H.FREE SPIRAL(NONFLAME)(WIRED)(GRAY)	19,1	24,7	50 mt.	250
001 020 151032 00 17	Ø32/1250N H.FREE SPIRAL(NONFLAME)(WIRED)(GRAY)	24,85	31,6	50 mt.	250
001 020 151040 00 17	Ø40 H.FREE SPIRAL(NONFLAME)(WIRED)(GRAY)			25 mt.	125

Code	Product Description	Inner Diameter	Outer Diameter	Number of Box	Quantity of Pack
PLASTIC SPIRALS (BLACK)					
001 020 400014 00 11	Ø14 PLASTIC SPIRAL(BLACK)	15,25	18,75	100 mt.	1000
001 020 400016 00 11	Ø16 PLASTIC SPIRAL(BLACK)	15,7	19	100 mt.	1000
001 020 400018 00 11	Ø18 PLASTIC SPIRAL(BLACK)	19,6	24,03	50 mt.	500
001 020 400020 00 11	Ø20 PLASTIC SPIRAL(BLACK)	19,6	24,03	50 mt.	500
001 020 400026 00 11	Ø26 PLASTIC SPIRAL(BLACK)	26,15	30,75	50 mt.	250
001 020 400032 00 11	Ø32 PLASTIC SPIRAL(BLACK)	29,1	34,3	50 mt.	250
001 020 400040 00 11	Ø40 PLASTIC SPIRAL(BLACK)	36,2	42,2	25 mt.	125
001 020 400050 00 11	Ø50 PLASTIC SPIRAL(BLACK)	48,5	54,5	25 mt.	125

PLASTIC SPIRALS (BLACK) (WIRED)

001 020 410014 00 11	Ø14 PLASTIC SPIRAL(WIRED)(BLACK)	15,25	18,75	100 mt.	1000
001 020 410016 00 11	Ø16 PLASTIC SPIRAL(WIRED)(BLACK)	15,7	19	100 mt.	1000
001 020 410018 00 11	Ø18 PLASTIC SPIRAL(WIRED)(BLACK)	19,6	24,03	50 mt.	500
001 020 410020 00 11	Ø20 PLASTIC SPIRAL(WIRED)(BLACK)	19,6	24,03	50 mt.	500
001 020 410026 00 11	Ø26 PLASTIC SPIRAL(WIRED)(BLACK)	26,15	30,75	50 mt.	250
001 020 410032 00 11	Ø32 PLASTIC SPIRAL(WIRED)(BLACK)	29,1	34,3	50 mt.	250
001 020 410040 00 11	Ø40 PLASTIC SPIRAL(WIRED)(BLACK)	36,2	42,2	25 mt.	125

PLASTIC SPIRALS (COLOURED)

001 020 400014 00 XX	Ø14 PLASTIC SPIRAL	15,25	18,75	100 mt.	1000
001 020 400016 00 XX	Ø16 PLASTIC SPIRAL	15,7	19	100 mt.	1000
001 020 400018 00 XX	Ø18 PLASTIC SPIRAL	19,6	24,03	50 mt.	500
001 020 400020 00 XX	Ø20 PLASTIC SPIRAL	19,6	24,03	50 mt.	250
001 020 400026 00 XX	Ø26 PLASTIC SPIRAL	26,15	30,75	50 mt.	250
001 020 400032 00 XX	Ø32 PLASTIC SPIRAL	29,1	34,3	50 mt.	250
001 020 400040 00 XX	Ø40 PLASTIC SPIRAL	36,2	42,2	25 mt.	125
001 020 400050 00 XX	Ø50 PLASTIC SPIRAL	48,5	54,5	25 mt.	125
001 020 990016 00 XX	Ø16 SPIRAL COUPLER			200 pcs.	
001 020 990020 00 XX	Ø20 SPIRAL COUPLER			200 pcs.	
001 020 990025 00 XX	Ø25 SPIRAL COUPLER			100 pcs.	
001 020 990032 00 XX	Ø32 SPIRAL COUPLER			200 pcs.	

HDPE CORRUGATED PIPES



096 045 150050	50Ø CORRUGATED PIPES	100	mt.
096 045 150060	63Ø CORRUGATED PIPES	100	mt.
096 045 150075	75Ø CORRUGATED PIPES	100	mt.
096 045 150100	100Ø CORRUGATED TUBE COIL (6 MT.)	6	mt.
096 045 150115	115Ø CORRUGATED TUBE COIL (6 MT.)	6	mt.
096 045 150004	50Ø SLEEVE	1	pcs.
096 045 150003	75Ø SLEEVE	1	pcs.
096 045 150002	100Ø SLEEVE	1	pcs.
096 045 150001	115Ø SLEEVE	1	pcs.

MANHOLE BOX

074 048 622020	20X20 MANHOLE BOX SET	1	pcs.
074 048 623030	30X30 MANHOLE BOX SET	1	pcs.
074 048 624040	40X40 MANHOLE BOX SET	1	pcs.
074 048 625050	50X50 MANHOLE BOX SET	1	pcs.
074 048 625555	55X55 MANHOLE BOX SET	1	pcs.

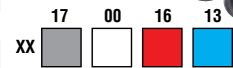

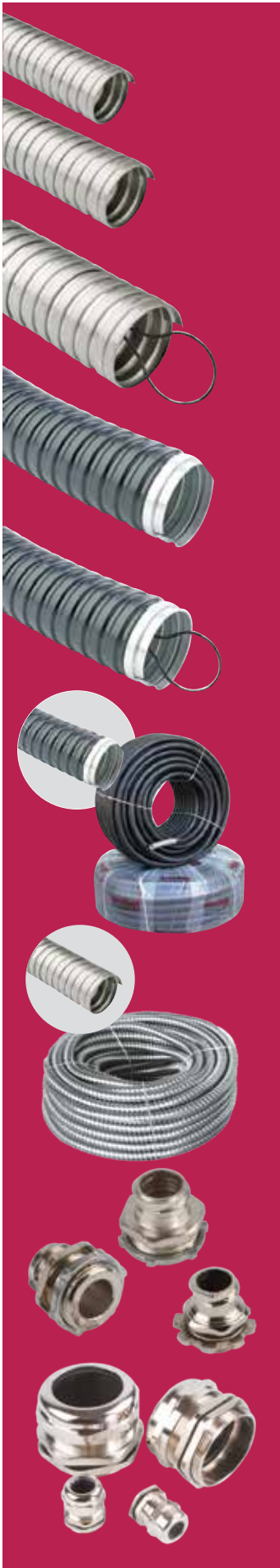

Code	Product Description	Inner Diameter	Outer Diameter	Number of Box	Quantity of Pack
STEEL SPIRALS					
001 054 120009 00 66	Ø9 METAL SPIRAL	9	12,1	50 mt.	200
001 054 120011 00 66	Ø11 METAL SPIRAL	11	14,1	50 mt.	200
001 054 120014 00 66	Ø14 METAL SPIRAL	14	17,1	50 mt.	200
001 054 120016 00 66	Ø16 METAL SPIRAL	16	19,1	50 mt.	200
001 054 120018 00 66	Ø18 METAL SPIRAL	18	21,1	50 mt.	200
001 054 120021 00 66	Ø21 METAL SPIRAL	21	24,1	50 mt.	200
001 054 120026 00 66	Ø26 METAL SPIRAL	26	29,1	25 mt.	100
001 054 120029 00 66	Ø29 METAL SPIRAL	29	32,1	25 mt.	100
001 054 120032 00 66	Ø32 METAL SPIRAL	32	35,1	25 mt.	100
001 054 120037 00 66	Ø37 METAL SPIRAL	37	41,1	25 mt.	100
001 054 120042 00 66	Ø42 METAL SPIRAL	42	45,1	25 mt.	100
001 054 120050 00 66	Ø50 METAL SPIRAL	50	53,1	25 mt.	100
001 054 120063 00 66	Ø63 METAL SPIRAL	63	66,1	15 mt.	60
STEEL SPIRALS (WIRED)					
001 054 121011 00 66	Ø11 METAL SPIRAL (WIRED)	11	14,1	50 mt.	200
001 054 121014 00 66	Ø14 METAL SPIRAL (WIRED)	14	17,1	50 mt.	200
001 054 121016 00 66	Ø16 METAL SPIRAL (WIRED)	16	19,1	50 mt.	200
001 054 121018 00 66	Ø18 METAL SPIRAL (WIRED)	18	21,1	50 mt.	200
001 054 121021 00 66	Ø21 METAL SPIRAL (WIRED)	21	24,1	50 mt.	200
001 054 121026 00 66	Ø26 METAL SPIRAL (WIRED)	26	29,1	25 mt.	100
001 054 121029 00 66	Ø29 METAL SPIRAL (WIRED)	29	32,1	25 mt.	100
001 054 121032 00 66	Ø32 METAL SPIRAL (WIRED)	32	35,1	25 mt.	100
001 054 121037 00 66	Ø37 METAL SPIRAL (WIRED)	37	41,1	25 mt.	100
001 054 121042 00 66	Ø42 METAL SPIRAL (WIRED)	42	45,1	25 mt.	100
001 054 121050 00 66	Ø50 METAL SPIRAL (WIRED)	50	53,1	25 mt.	100
001 054 121063 00 66	63 Ø STEEL SPIRALS	63	66,1	15 mt.	60
ISOLATED STEEL SPIRALS					
001 054 130009 00 11	Ø9 ISOLATED METAL SPIRAL (BLACK)	9	13,2	50 mt.	
001 054 130011 00 11	Ø11 ISOLATED METAL SPIRAL (BLACK)	11	15,2	50 mt.	
001 054 130014 00 11	Ø14 ISOLATED METAL SPIRAL (BLACK)	14	18,4	50 mt.	
001 054 130016 00 11	Ø16 ISOLATED METAL SPIRAL (BLACK)	16	20,4	50 mt.	
001 054 130018 00 11	Ø18 ISOLATED METAL SPIRAL (BLACK)	18	22,4	50 mt.	
001 054 130026 00 11	Ø26 ISOLATED METAL SPIRAL (BLACK)	26	30,4	25 mt.	
001 054 130029 00 11	Ø29 ISOLATED METAL SPIRAL (BLACK)	29	33,4	25 mt.	
001 054 130032 00 11	Ø32 ISOLATED METAL SPIRAL (BLACK)	32	36,4	25 mt.	
001 054 130037 00 11	Ø37 ISOLATED METAL SPIRAL (BLACK)	37	42,4	25 mt.	
001 054 130042 00 11	Ø42 ISOLATED METAL SPIRAL (BLACK)	42	46,4	25 mt.	
001 054 130050 00 11	Ø50 ISOLATED METAL SPIRAL (BLACK)	50	54,4	25 mt.	
001 054 130063 00 11	Ø63 ISOLATED METAL SPIRAL (BLACK)	63	67,2	15 mt.	
ISOLATED STEEL SPIRALS (WIRED)					
001 054 140011 00 11	Ø11 ISOLATED METAL SPIRAL (WIRED) (BLACK)	11	15,2	50 mt.	
001 054 140014 00 11	Ø14 ISOLATED METAL SPIRAL (WIRED) (BLACK)	14	18,4	50 mt.	
001 054 140016 00 11	Ø16 ISOLATED METAL SPIRAL (WIRED) (BLACK)	16	20,4	50 mt.	
001 054 140018 00 11	Ø18 ISOLATED METAL SPIRAL (WIRED) (BLACK)	18	22,4	50 mt.	
001 054 140026 00 11	Ø26 ISOLATED METAL SPIRAL (WIRED) (BLACK)	26	30,4	25 mt.	
001 054 140029 00 11	Ø29 ISOLATED METAL SPIRAL (WIRED) (BLACK)	29	33,4	25 mt.	
001 054 140032 00 11	Ø32 ISOLATED METAL SPIRAL (WIRED) (BLACK)	32	36,4	25 mt.	
001 054 140037 00 11	Ø37 ISOLATED METAL SPIRAL (WIRED) (BLACK)	37	42,4	25 mt.	
001 054 140042 00 11	Ø42 ISOLATED METAL SPIRAL (WIRED) (BLACK)	42	46,4	25 mt.	
001 054 140050 00 11	Ø50 ISOLATED METAL SPIRAL (WIRED) (BLACK)	50	54,4	25 mt.	
001 054 140063 00 11	Ø63 ISOLATED METAL SPIRAL (WIRED) (BLACK)	63	67,2	15 mt.	
NICKEL PLATED STEEL SPIRAL GLAND					
012 097 030009	CLK-9 NICKEL COA.METAL SPIRAL GLAND			150 pcs.	
012 097 030011	CLK-11 NICKEL COA.METAL SPIRAL GLAND			175 pcs.	
012 097 030014	CLK-14 NICKEL COA.METAL SPIRAL GLAND			90 pcs.	
012 097 030016	CLK-16 NICKEL COA.METAL SPIRAL GLAND			75 pcs.	
012 097 030018	CLK-18 NICKEL COA.METAL SPIRAL GLAND			80 pcs.	
012 097 030026	CLK-26 NICKEL COA.METAL SPIRAL GLAND			30 pcs.	
SUPER WATERPROOF METAL GLAND					
057 097 100007	PG-7 SUPER WATERPROOF METAL GLAND			1 pcs.	
057 097 100009	PG-9 SUPER WATERPROOF METAL GLAND			1 pcs.	
057 097 100011	PG-11 SUPER WATERPROOF METAL GLAND			1 pcs.	
057 097 100135	PG-13,5 SUPER WATERPROOF METAL GLAND			1 pcs.	
057 097 100016	PG-16 SUPER WATERPROOF METAL GLAND			1 pcs.	
057 097 100021	PG-21 SUPER WATERPROOF METAL GLAND			1 pcs.	
057 097 100029	PG-29 SUPER WATERPROOF METAL GLAND			1 pcs.	
057 097 100036	PG-36 SUPER WATERPROOF METAL GLAND			1 pcs.	
057 097 100042	PG-42 SUPER WATERPROOF METAL GLAND			1 pcs.	
057 097 100048	PG-48 SUPER WATERPROOF METAL GLAND			1 pcs.	

NEW

Pluggable Type and Spiked Junction Terminals

swiss SERIES

Cod	Product Description	PRICE
PLUGGABLE JUNCTION TERMINALS		
999 094 225000	2 GANG PLUGGABLE JUNCTION TERMINALS	100 pcs. 6000
999 094 325000	3 GANG PLUGGABLE JUNCTION TERMINALS	100 pcs. 6000
999 094 425000	4 GANG PLUGGABLE JUNCTION TERMINALS	100 pcs. 6000
999 094 525000	5 GANG PLUGGABLE JUNCTION TERMINALS	100 pcs. 6000
SPIKED JUNCTION TERMINALS		
999 094 241000	2 GANG SPIKED JUNCTION TERMINALS	100 pcs. 2400
999 094 341000	3 GANG SPIKED JUNCTION TERMINALS	100 pcs. 2400
999 094 541000	5 GANG SPIKED JUNCTION TERMINALS	50 pcs. 1200
PLUGGABLE JUNCTION TERMINALS		
888 094 260802	BM802 WIRE CONNECTOR(2)	400 6400
015 094 160001	NO.2 ZEYTIN WIRE CONNECTOR	1000 5000
TRANSPARENT HEAT RESISTANT JUNCTION TERMINALS		
888 094 000105	NO.2 FEED THROUGH TERM.BLOCK	560 pcs.
888 094 000205	NO.3 FEED THROUGH TERM.BLOCK	360 pcs.
888 094 000405	NO.4 FEED THROUGH TERM.BLOCK	300 pcs.
888 094 000605	NO.5 FEED THROUGH TERM.BLOCK	160 pcs.
PLUGGABLE SOCKET TERMINAL		
999 999 991212	PLUGGABLE SOCKET 12 TERMINAL	25 pcs.
PLASTIC TERMINAL BLOCKS		
015 094 150001	NO.1 FEED THORUGH TER.BLOCK (2.5-4 MM2) BLACK	50 pcs. 1000
015 094 150002	NO.2 FEED THORUGH TER.BLOCK (4-6 MM2) BLACK	50 pcs. 1000
015 094 150003	NO.3 FEED THORUGH TER.BLOCK (10-16 MM2) BLACK	50 pcs. 500
015 094 150004	NO.4 FEED THORUGH TER.BLOCK (16-25 MM2) BLACK	50 pcs. 500
015 094 150005	NO 5 TERMINAL STRIPS BLACK	50 pcs. 500
HEAT RESISTANT TERMINAL BLOCKS CE		
015 094 170001	NO.1 NONFLAM. F.THOU.TER.BLO.(2.5-4 MM2)	50 pcs. 1000
015 094 170002	NO.2 NONFLAM. F.THOU.TER.BLOCK (4-6 MM2)	50 pcs. 1000
015 094 170003	NO.3 NONFLAM. F.THOU.TER.BLO.(10-16 MM2)	50 pcs. 500
015 094 170004	NO.4 NONFLAM. F.THOU.TER.BLO.(16-25 MM2)	50 pcs. 500
015 094 170005	NO:5 NON-FLAMMABLE TERMINAL STRIPS (25MM2)	50 pcs. 500
CERAMIC TERMINALS		
015 094 180002	NO.1-2 PORCELAIN TERMINAL BLOCK	300 pcs.
015 094 180003	NO.1-3 PORCELAIN TERMINAL BLOCK	220 pcs.
015 094 180004	NO.2-2 PORCELAIN TERMINAL BLOCK	200 pcs.
015 094 180005	NO.2-3 PORCELAIN TERMINAL BLOCK	177 pcs.
015 094 180006	NO.3-2 PORCELAIN TERMINAL BLOCK	104 pcs.
015 094 180007	NO.3-3 PORCELAIN TERMINAL BLOCK	64 pcs.
U TERMINAL		
014 094 030006	6-GANG U TERMINAL	300 pcs.
014 094 030010	10-GANG U TERMINAL	250 pcs.
014 094 030016	16-GANG U TERMINAL	100 pcs.
014 094 030025	25-GANG U TERMINAL	100 pcs.
014 094 030035	35-GANG U TERMINAL	75 pcs.
014 094 030050	50-GANG U TERMINAL	50 pcs.
014 094 030070	70-GANG U TERMINAL	40 pcs.
014 094 030095	95-GANG U TERMINAL	25 pcs.
014 094 030120	120-GANG U TERMINAL	20 pcs.
014 094 030150	150-GANG U TERMINAL	15 pcs.

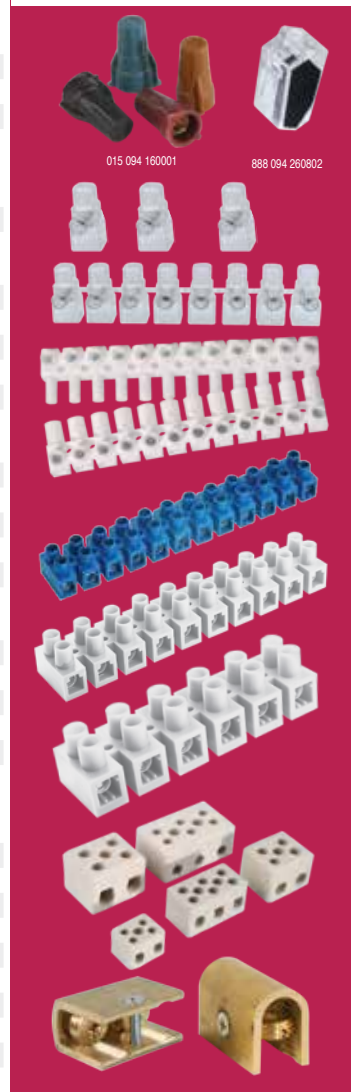
NEW















Code	Product Description		Number of Box	Quantity of Pack
PVC NON-FLAME PROPAGATING PIPES (750N)				
001 045 120014 30 XX	Ø14 PVC NON-FLAME PROPAGATING PIPE(3M)	☐ €	102	mt.
001 045 120016 30 XX	Ø16 PVC NON-FLAME PROPAGATING PIPE(3M)	◊ €	102	mt.
001 045 120018 30 XX	Ø18 PVC NON-FLAME PROPAGATING PIPE(3M)	☐ €	102	mt.
001 045 120020 30 XX	Ø20 PVC NON-FLAME PROPAGATING PIPE(3M)	◊ €	102	mt.
001 045 120025 30 XX	Ø25 PVC NON-FLAME PROPAGATING PIPE(3M)	◊ €	51	mt.
001 045 120032 30 XX	Ø32 PVC NON-FLAME PROPAGATING PIPE(3M)	◊ €	30	mt.
001 045 120040 30 XX	Ø40 PVC NON-FLAME PROPAGATING PIPE(3M)	◊ €	30	mt.
PVC NON-FLAME PROPOGATING PIPES WITH SOCKET (750N)				
001 045 110014 30 XX	Ø14 PVC NON-FLAME PROPOGATING PIPES WITH SOCKET (3M)	☐ €	102	mt.
001 045 110016 30 XX	Ø16 PVC NON-FLAME PROPOGATING PIPES WITH SOCKET (3M)	◊ €	102	mt.
001 045 110018 30 XX	Ø18 PVC NON-FLAME PROPOGATING PIPES WITH SOCKET (3M)	☐ €	102	mt.
001 045 110020 30 XX	Ø20 PVC NON-FLAME PROPOGATING PIPES WITH SOCKET (3M)	◊ €	102	mt.
001 045 110025 30 XX	Ø25 PVC NON-FLAME PROPOGATING PIPES WITH SOCKET (3M)	◊ €	51	mt.
001 045 110032 30 XX	Ø32 PVC NON-FLAME PROPOGATING PIPES WITH SOCKET (3M)	◊ €	30	mt.
001 045 110040 30 XX	Ø40 PVC NON-FLAME PROPOGATING PIPES WITH SOCKET (3M)	◊ €	30	mt.
ELBOW AND PIPE SOCKETS FLAME RETARDANT				
001 051 010014 00 XX	Ø14 FLAME RETARDANT BRACKETS	☐ €	100 pcs.	700
001 051 010016 00 XX	Ø16 FLAME RETARDANT BRACKETS	◊ €	100 pcs.	600
001 051 010018 00 XX	Ø18 FLAME RETARDANT BRACKETS	☐ €	100 pcs.	400
001 051 010020 00 XX	Ø20 FLAME RETARDANT BRACKETS	◊ €	100 pcs.	300
001 051 010025 00 XX	Ø25 FLAME RETARDANT BRACKETS	◊ €	50 pcs.	150
001 051 010032 00 XX	Ø32 FLAME RETARDANT BRACKETS	◊ €	50 pcs.	100
001 051 030014 00 XX	Ø14-16 FLAME RETARDANT COUPLER FITTING	◊ €	100 pcs.	700
001 051 030018 00 XX	Ø18-20 FLAME RETARDANT COUPLER FITTING	◊ €	100 pcs.	500
001 051 030025 00 XX	Ø25 FLAME RETARDANT COUPLER FITTING	◊ €	50 pcs.	300
001 051 030032 00 XX	Ø32 FLAME RETARDANT COUPLER FITTING	◊ €	50 pcs.	200
PLUGGABLE ANTIGRONE PIPE CROCHETS GRAY COLOUR				
001 048 010016 00 17	PIPE CROCHET(16)(SURF.MO.)(GRAY)		100 pcs.	2000
001 048 010018 00 17	PIPE CROCHET(18)(SURF.MO.)(GRAY)		100 pcs.	4000
001 048 010020 00 17	PIPE CROCHET(20)(SURF.MO.)(GRAY)		100 pcs.	1500
001 048 010025 00 17	PIPE CROCHET(25)(SURF.MO.)(GRAY)		100 pcs.	1000
001 048 010032 00 17	PIPE CROCHET(32)(SURF.MO.)(GRAY)		100 pcs.	800
001 048 010040 00 17	PIPE CROCHET(40)(SURF.MO.)(GRAY)		100 pcs.	1000
074 048 050016	16 Ø ANTIGRONE PIPE CROCHETS COVERED(PLUGGABLE)		100 pcs.	4000
074 048 050017	20 Ø ANTIGRONE PIPE CROCHETS COVERED(PLUGGABLE)		100 pcs.	3000
074 048 050025	25 Ø ANTIGRONE PIPE CROCHETS COVERED(PLUGGABLE)		100 pcs.	2500
074 048 050032	32 Ø ANTIGRONE PIPE CROCHETS COVERED(PLUGGABLE)		50 pcs.	1500
PVC. ISOLATED METAL CABLE PULLER				
049 019 300010	10 MT. PVC ISOLATED METAL CABLE PULLER		1 pcs.	30
049 019 300015	15 MT. PVC ISOLATED METAL CABLE PULLER		1 pcs.	24
049 019 300020	20 MT. PVC ISOLATED METAL CABLE PULLER		1 pcs.	20
049 019 300025	25 MT. PVC ISOLATED METAL CABLE PULLER		1 pcs.	18
PLASTIC CABLE PULLER				
049 019 400010	10 MT PLASTIC CABLE PULLER WHITE		1 pcs.	25
049 019 400015	15 MT PLASTIC CABLE PULLER WHITE		1 pcs.	20
049 019 400020	20 MT PLASTIC CABLE PULLER WHITE		1 pcs.	15
049 019 400025	25 MT PLASTIC CABLE PULLER WHITE		1 pcs.	15
STEEL CABLE PULLER AND CHAIN				
001 019 000010 00 00	CABLE PULLER(1.QUALITY)(10M)		40 pcs.	40
001 019 000015 00 00	CABLE PULLER(1.QUALITY)(15M)		30 pcs.	30
001 019 000020 00 00	CABLE PULLER(1.QUALITY)(20M)		20 pcs.	20
001 019 000025 00 00	CABLE PULLER(1.QUALITY)(25M)		15 pcs.	15
001 019 100010 00 00	WIRED CABLE PULLER(1.QUALITY)(10M)		40 pcs.	40
001 019 100015 00 00	WIRED CABLE PULLER(1.QUALITY)(15M)		30 pcs.	30
001 019 100020 00 00	WIRED CABLE PULLER(1.QUALITY)(20M)		20 pcs.	20
001 019 100025 00 00	WIRED CABLE PULLER(1.QUALITY)(25M)		15 pcs.	15
001 018 000001 00 00	FLUORESCENT CHAIN		100 mt.	500

Code	Product Description	Number of Box	Quantity of Pack
SÍBOR (H.FREE) FLAME PROPAGATING PIPE (320N)			
001 045 600016 30 XX	Ø16/320N (H.FREE) FLAME PROPAGATING PIPE	102	mt.
001 045 600020 30 XX	Ø20/320N (H.FREE) FLAME PROPAGATING PIPE	102	mt.
001 045 600025 30 XX	Ø25/320N (H.FREE) FLAME PROPAGATING PIPE	51	mt.
001 045 600032 30 XX	Ø32/320N (H.FREE) FLAME PROPAGATING PIPE	30	mt.
SÍBOR (H.FREE) FLAME RETARDANT PIPE (320N)			
001 045 160016 30 XX	Ø16/320N (H.FREE) FLAME RETARDANT PIPE	102	mt.
001 045 160020 30 XX	Ø20/320N (H.FREE) FLAME RETARDANT PIPE	102	mt.
001 045 160025 30 XX	Ø25/320N (H.FREE) FLAME RETARDANT PIPE	51	mt.
001 045 160032 30 XX	Ø32/320N (H.FREE) FLAME RETARDANT PIPE	30	mt.
SÍBOR (H.FREE) FLAME PROPAGATING PIPE (750N)			
001 045 610016 30 XX	Ø16/750N (H.FREE) FLAME PROPAGATING PIPE	102	mt.
001 045 610020 30 XX	Ø20/750N (H.FREE) FLAME PROPAGATING PIPE	102	mt.
001 045 610025 30 XX	Ø25/750N (H.FREE) FLAME PROPAGATING PIPE	51	mt.
001 045 610032 30 XX	Ø32/750N (H.FREE) FLAME PROPAGATING PIPE	30	mt.
SÍBOR (H.FREE) FLAME RETARDANT PIPE (750N)			
001 045 161016 30 XX	Ø16/750N (H.FREE) FLAME RETARDANT PIPE	102	mt.
001 045 161020 30 XX	Ø20/750N (H.FREE) FLAME RETARDANT PIPE	102	mt.
001 045 161025 30 XX	Ø25/750N (H.FREE) FLAME RETARDANT PIPE	51	mt.
001 045 161032 30 XX	Ø32/750N (H.FREE) FLAME RETARDANT PIPE	30	mt.
SÍBOR (H.FREE) FLAME PROPAGATING PIPE (1250N)			
001 045 620020 30 XX	Ø20/1250N (H.FREE) FLAME PROPAGATING PIPE	102	mt.
001 045 620025 30 XX	Ø25/1250N (H.FREE) FLAME PROPAGATING PIPE	51	mt.
SÍBOR (H.FREE) FLAME RETARDANT PIPE (1250N)			
001 045 162020 30 XX	Ø20/1250N (H.FREE) FLAME RETARDANT PIPE	102	mt.
001 045 162025 30 XX	Ø25/1250N (H.FREE) FLAME RETARDANT PIPE	51	mt.
H.FREE FLAME RETARDANT PIPE (320N)			
001 045 500016 30 XX	Ø16/320N (H.FREE) FLAME RETARDANT PIPE(3M)	102	mt.
001 045 500020 30 XX	Ø20/320N (H.FREE) FLAME RETARDANT PIPE(3M)	102	mt.
001 045 500025 30 XX	Ø25/320N (H.FREE) FLAME RETARDANT PIPE(3M)	102	mt.
001 045 500032 30 XX	Ø32/320N (H.FREE) FLAME RETARDANT PIPE(3M)	102	mt.
001 045 500040 30 XX	Ø40/320N (H.FREE) FLAME RETARDANT PIPE(3M)	51	mt.
001 045 500050 30 XX	Ø50/320N (H.FREE) FLAME RETARDANT PIPE(3M)	30	mt.
HALOGEN FREE FLAME RETARDANT PIPES (750N)			
001 045 510016 30 XX	Ø16/750N(H.FREE) FLAME RETARDANT PIPE(3M)	102	mt.
001 045 510020 30 XX	Ø20/750N (H.FREE) FLAME RETARDANT PIPE(3M)	102	mt.
001 045 510025 30 XX	Ø25/750N (H.FREE) FLAME RETARDANT PIPE(3M)	102	mt.
001 045 510032 30 XX	Ø32/750N (H.FREE) FLAME RETARDANT PIPE(3M)	102	mt.
001 045 510040 30 XX	Ø40/750N (H.FREE) FLAME RETARDANT PIPE(3M)	51	mt.
001 045 510050 30 XX	Ø50/750N (H.FREE) FLAME RETARDANT PIPE(3M)	30	mt.
HALOGEN FREE FLAME RETARDANT PIPES (1250N)			
001 045 520016 30 XX	Ø16/1250N(H.FREE) FLAME RETARDANT PIPE(3M)	102	mt.
001 045 520020 30 XX	Ø20/1250N (H.FREE) FLAME RETARDANT PIPE(3M)	102	mt.
001 045 520025 30 XX	Ø25/1250N (H.FREE) FLAME RETARDANT PIPE(3M)	102	mt.
001 045 520032 30 XX	Ø32/1250N (H.FREE) FLAME RETARDANT PIPE(3M)	102	mt.
001 045 520040 30 XX	Ø40/1250N (H.FREE) FLAME RETARDANT PIPE(3M)	51	mt.
001 045 520050 30 XX	Ø50/1250N (H.FREE) FLAME RETARDANT PIPE(3M)	30	mt.
TRANSPARENT H.F FLAME-PROPAGATING PIPE-SPRAL ADDITIONAL PIPE SOCKET			
999 999 777616	16 TRANSPARENT H.F FLAME-PROPAGATING SPIRAL JUNCTION PART	100 pcs	
999 999 777620	20 TRANSPARENT H.F FLAME-PROPAGATING SPIRAL JUNCTION PART	100 pcs	
999 999 777625	25 TRANSPARENT H.F FLAME-PROPAGATING SPIRAL JUNCTION PART	100 pcs	
999 999 777632	32 TRANSPARENT H.F FLAME-PROPAGATING SPIRAL JUNCTION PART	100 pcs	
FLATPIPE T ELBOW H.FREE FLAME RETARDANT			
999 999 999888	16 FLAME RETARDANT T CORNER	100 pcs	300
999 999 999889	20 FLAME RETARDANT T CORNER	100 pcs	300
999 999 999890	25 FLAME RETARDANT T CORNER	100 pcs	300
999 999 999891	32 FLAME RETARDANT T CORNER	100 pcs	200
FLATPIPE UNION H.FREE FLAME RETARDANT			
999 999 998816	FIREPROOF 16 PCS STRAIGHT PIPE RECORD	100 pcs	
999 999 998820	FIREPROOF 20 PCS STRAIGHT PIPE RECORD	100 pcs	
999 999 998825	FIREPROOF 25 PCS STRAIGHT PIPE RECORD	100 pcs	
999 999 998832	FIREPROOF 32 PCS STRAIGHT PIPE RECORD	100 pcs	
ANTIGRONE PIPE CROCHETS (PLUGGABLE) H.FREE FLAME RETARDANT			
074 048 060016	Ø16 H.FREE ANTIGRON PIPE CROCHET WITH LID	100 pcs	
074 048 060020	Ø20 H.FREE ANTIGRON PIPE CROCHET WITH LID	100 pcs	
074 048 060025	Ø25 H.FREE ANTIGRON PIPE CROCHET WITH LID	100 pcs	
074 048 060032	Ø32 H.FREE ANTIGRON PIPE CROCHET WITH LID	50 pcs	
SPIRAL UNION H.FREE FLAME RETARDANT			
999 999 777516	Ø16 SPIRAL UNION H.FREE FLAME RETARDANT	100 pcs	
999 999 777520	Ø20 SPIRAL UNION H.FREE FLAME RETARDANT	100 pcs	
999 999 777525	Ø25 SPIRAL UNION H.FREE FLAME RETARDANT	100 pcs	
999 999 777532	Ø32 SPIRAL UNION H.FREE FLAME RETARDANT	50 pcs	





Code	Product Description	Number of Box	Quantity of Pack
HALOGEN FREE ORANGE PIPES (FLAME-PROPAGATING)(320N)			
001 165 506014 00 12	Ø14/320N POLYETHYLENE PIPE(H.FREE)(ORANGE)	100	mt.
001 165 506016 00 12	Ø16/320N POLYETHYLENE PIPE(H.FREE)(ORANGE)  	100	mt.
001 165 506018 00 12	Ø18/320N POLYETHYLENE PIPE(H.FREE)(ORANGE)	100	mt.
001 165 506020 00 12	Ø20/320N POLYETHYLENE PIPE(H.FREE)(ORANGE)  	100	mt.
001 165 506025 00 12	Ø25/320N POLYETHYLENE PIPE(H.FREE)(ORANGE)  	100	mt.
001 165 506032 00 12	Ø32/320N POLYETHYLENE PIPE(H.FREE)(ORANGE)  	100	mt.
001 165 506037 00 12	Ø37/320N POLYETHYLENE PIPE(H.FREE)(ORANGE)	100	mt.
001 165 506040 00 12	Ø40/320N POLYETHYLENE PIPE(H.FREE)(ORANGE)  	100	mt.
001 165 506050 00 12	Ø50/320N POLYETHYLENE PIPE(H.FREE)(ORANGE)  	100	mt.
001 165 506063 00 12	Ø63/320N POLYETHYLENE PIPE(H.FREE)(ORANGE)  	100	mt.
001 165 506075 00 12	Ø75/320N POLYETHYLENE PIPE(H.FREE)(ORANGE)  	100	mt.
001 165 506090 00 12	Ø90/320N POLYETHYLENE PIPE(H.FREE)(ORANGE)	75	mt.
HALOGEN FREE PIPES (FLAME-PROPAGATING)(750N)			
001 165 510014 00 12	Ø14/750N POLYETHYLENE PIPE(H.FREE)(ORANGE)	100	mt.
001 165 510016 00 12	Ø16/750N POLYETHYLENE PIPE(H.FREE)(ORANGE)  	100	mt.
001 165 510018 00 12	Ø18/750N POLYETHYLENE PIPE(H.FREE)(ORANGE)	100	mt.
001 165 510020 00 12	Ø20/750N POLYETHYLENE PIPE(H.FREE)(ORANGE)  	100	mt.
001 165 510025 00 12	Ø25/750N POLYETHYLENE PIPE(H.FREE)(ORANGE)  	100	mt.
001 165 510032 00 12	Ø32/750N POLYETHYLENE PIPE(H.FREE)(ORANGE)  	100	mt.
001 165 510037 00 12	Ø37/750N POLYETHYLENE PIPE(H.FREE)(ORANGE)	100	mt.
001 165 510040 00 12	Ø40/750N POLYETHYLENE PIPE(H.FREE)(ORANGE)  	100	mt.
001 165 510050 00 12	Ø50/750N POLYETHYLENE PIPE(H.FREE)(ORANGE)  	100	mt.
001 165 510063 00 12	Ø63/750N POLYETHYLENE PIPE(H.FREE)(ORANGE)  	100	mt.
001 165 510075 00 12	Ø75/750N POLYETHYLENE PIPE(H.FREE)(ORANGE)  	100	mt.
001 165 510090 00 12	Ø90/750N POLYETHYLENE PIPE(H.FREE)(ORANGE)	75	mt.
001 165 510100 00 12	Ø100/750N POLYETHYLENE PIPE(H.FREE)(ORANGE)	50	mt.
001 165 510110 00 12	Ø110/750N POLYETHYLENE PIPE(H.FREE)(ORANGE)	50	mt.
HALOGEN FREE PIPES (FLAME-PROPAGATING)(1250N)			
001 165 512020 00 12	Ø20/1250N POLYETHYLENE PIPE(H.FREE)(ORANGE)  	100	mt.
001 165 512025 00 12	Ø25/1250N POLYETHYLENE PIPE(H.FREE)(ORANGE)  	100	mt.
001 165 512032 00 12	Ø32/1250N POLYETHYLENE PIPE(H.FREE)(ORANGE)  	100	mt.
HALOGEN FREE PIPES (FLAME RETARDANT)(320N)			
001 165 106014 00 12	Ø14/320N POLYETHYLENE PIPE(H.FREE)(FLAME RETARDANT)(ORANGE)	100	mt.
001 165 106016 00 12	Ø16/320N POLYETHYLENE PIPE(H.FREE)(FLAME RETARDANT)(ORANGE)  	100	mt.
001 165 106018 00 12	Ø18/320N POLYETHYLENE PIPE(H.FREE)(FLAME RETARDANT)(ORANGE)	100	mt.
001 165 106020 00 12	Ø20/320N POLYETHYLENE PIPE(H.FREE)(FLAME RETARDANT)(ORANGE)  	100	mt.
001 165 106025 00 12	Ø25/320N POLYETHYLENE PIPE(H.FREE)(FLAME RETARDANT)(ORANGE)  	100	mt.
001 165 106032 00 12	Ø32/320N POLYETHYLENE PIPE(H.FREE)(FLAME RETARDANT)(ORANGE)  	100	mt.
001 165 106037 00 12	Ø37/320N POLYETHYLENE PIPE (H.FREE)(FLAME RETARDANT)(ORANGE)	100	mt.
001 165 106040 00 12	Ø40/320N POLYETHYLENE PIPE(H.FREE)(FLAME RETARDANT)(ORANGE)  	100	mt.
001 165 106050 00 12	Ø50/320N POLYETHYLENE PIPE(H.FREE)(FLAME RETARDANT)(ORANGE)  	100	mt.
001 165 106063 00 12	Ø63/320N POLYETHYLENE PIPE(H.FREE)(FLAME RETARDANT)(ORANGE)  	100	mt.
001 165 106075 00 12	Ø75/320N POLYETHYLENE PIPE(H.FREE)(FLAME RETARDANT)(ORANGE)  	100	mt.
001 165 106090 00 12	Ø90/320N POLYETHYLENE PIPE(H.FREE)(FLAME RETARDANT)(ORANGE)	75	mt.
HALOGEN FREE PIPES (FLAME RETARDANT)(750N)			
001 165 110014 00 12	Ø14/750N POLYETHYLENE PIPE(H.FREE)(FLAME RETARDANT)(ORANGE)	100	mt.
001 165 110016 00 12	Ø16/750N POLYETHYLENE PIPE(H.FREE)(FLAME RETARDANT)(ORANGE)  	100	mt.
001 165 110018 00 12	Ø18/750N POLYETHYLENE PIPE(H.FREE)(FLAME RETARDANT)(ORANGE)	100	mt.
001 165 110020 00 12	Ø20/750N POLYETHYLENE PIPE(H.FREE)(FLAME RETARDANT)(ORANGE)  	100	mt.
001 165 110025 00 12	Ø25/750N POLYETHYLENE PIPE(H.FREE)(FLAME RETARDANT)(ORANGE)  	100	mt.
001 165 110032 00 12	Ø32/750N POLYETHYLENE PIPE(H.FREE)(FLAME RETARDANT)(ORANGE)  	100	mt.
001 165 110037 00 12	Ø37/750N POLYETHYLENE PIPE(H.FREE)(FLAME RETARDANT)(ORANGE)	100	mt.
001 165 110040 00 12	Ø40/750N POLYETHYLENE PIPE(H.FREE)(FLAME RETARDANT)(ORANGE)  	100	mt.
001 165 110050 00 12	Ø50/750N POLYETHYLENE PIPE(H.FREE)(FLAME RETARDANT)(ORANGE)  	100	mt.
001 165 110063 00 12	Ø63/750N POLYETHYLENE PIPE(H.FREE)(FLAME RETARDANT)(ORANGE)  	100	mt.
001 165 110075 00 12	Ø75/750N POLYETHYLENE PIPE (H.FREE)(FLAME RETARDANT)(ORANGE)  	100	mt.
001 165 110090 00 12	Ø90/750N POLYETHYLENE PIPE(H.FREE)(FLAME RETARDANT)(ORANGE)	75	mt.
001 165 110100 00 12	Ø100/750N POLYETHYLENE PIPE(H.FREE)(FLAME RETARDANT)(ORANGE)	50	mt.
001 165 110110 00 12	Ø110/750N POLYETHYLENE PIPE(H.FREE)(FLAME RETARDANT)(ORANGE)	50	mt.
HALOGEN FREE PIPES (FLAME RETARDANT)(1250N)			
001 165 112020 00 12	Ø20/1250N POLYETHYLENE PIPE(H.FREE)(FLAME RETARDANT)(ORANGE)  	100	mt.
001 165 112025 00 12	Ø25/1250N POLYETHYLENE PIPE(H.FREE)(FLAME RETARDANT)(ORANGE)  	100	mt.
001 165 112032 00 12	Ø32/1250N POLYETHYLENE PIPE(H.FREE)(FLAME RETARDANT)(ORANGE)  	100	mt.

Code	Product Description	Number of Box	Quantity of Pack	
MEKS POLYETHYLENE PIPE (WIRED)(H.FREE)(ORANGE)(320N)				
001 165 906014 00 12	Ø14/320N POLYETHYLENE PIPE (WIRED)(H.FREE)(ORANGE)	100	mt.	
001 165 906016 00 12	Ø16/320N POLYETHYLENE PIPE (WIRED)(H.FREE)(ORANGE)	100	mt.	
001 165 906018 00 12	Ø18/320N POLYETHYLENE PIPE (WIRED)(H.FREE)(ORANGE)	100	mt.	
001 165 906020 00 12	Ø20/320N POLYETHYLENE PIPE (WIRED)(H.FREE)(ORANGE)	100	mt.	
001 165 906025 00 12	Ø25/320N POLYETHYLENE PIPE (WIRED)(H.FREE)(ORANGE)	100	mt.	
001 165 906032 00 12	Ø32/320N POLYETHYLENE PIPE (WIRED)(H.FREE)(ORANGE)	100	mt.	
001 165 906037 00 12	Ø37/320N POLYETHYLENE PIPE (WIRED)(H.FREE)(ORANGE)	100	mt.	
001 165 906040 00 12	Ø40/320N POLYETHYLENE PIPE (WIRED)(H.FREE)(ORANGE)	100	mt.	
MEKS POLYETHYLENE PIPE (WIRED)(H.FREE)(ORANGE)(750N)				
001 165 910014 00 12	Ø14/750N POLYETHYLENE PIPE (WIRED)(H.FREE)(ORANGE)	100	mt.	
001 165 910016 00 12	Ø16/750N POLYETHYLENE PIPE (WIRED)(H.FREE)(ORANGE)	100	mt.	
001 165 910018 00 12	Ø18/750N POLYETHYLENE PIPE (WIRED)(H.FREE)(ORANGE)	100	mt.	
001 165 910020 00 12	Ø20/750N POLYETHYLENE PIPE (WIRED)(H.FREE)(ORANGE)	100	mt.	
001 165 910025 00 12	Ø25/750N POLYETHYLENE PIPE (WIRED)(H.FREE)(ORANGE)	100	mt.	
001 165 910032 00 12	Ø32/750N POLYETHYLENE PIPE (WIRED)(H.FREE)(ORANGE)	100	mt.	
001 165 910037 00 12	Ø37/750N POLYETHYLENE PIPE (WIRED)(H.FREE)(ORANGE)	100	mt.	
001 165 910040 00 12	Ø40/750N POLYETHYLENE PIPE (WIRED)(H.FREE)(ORANGE)	100	mt.	
MEKS POLYETHYLENE PIPE (WIRED)(H.FREE)(FLAME RETARDANT)(ORANGE)(320N)				
001 165 306014 00 12	Ø14/320N POLYETHYLENE PIPE (WIRED)(H.FREE)(FLAME RETARDANT)(ORANGE)	100	mt.	
001 165 306016 00 12	Ø16/320N POLYETHYLENE PIPE (WIRED)(H.FREE)(FLAME RETARDANT)(ORANGE)	100	mt.	
001 165 306018 00 12	Ø18/320N POLYETHYLENE PIPE (WIRED)(H.FREE)(FLAME RETARDANT)(ORANGE)	100	mt.	
001 165 306020 00 12	Ø20/320N POLYETHYLENE PIPE (WIRED)(H.FREE)(FLAME RETARDANT)(ORANGE)	100	mt.	
001 165 306025 00 12	Ø25/320N POLYETHYLENE PIPE (WIRED)(H.FREE)(FLAME RETARDANT)(ORANGE)	100	mt.	
001 165 306032 00 12	Ø32/320N POLYETHYLENE PIPE (WIRED)(H.FREE)(FLAME RETARDANT)(ORANGE)	100	mt.	
001 165 306037 00 12	Ø37/320N POLYETHYLENE PIPE (WIRED)(H.FREE)(FLAME RETARDANT)(ORANGE)	100	mt.	
001 165 306040 00 12	Ø40/320N POLYETHYLENE PIPE (WIRED)(H.FREE)(FLAME RETARDANT)(ORANGE)	100	mt.	
MEKS POLYETHYLENE PIPE (WIRED)(H.FREE)(FLAME RETARDANT)(ORANGE)(750N)				
001 165 310014 00 12	Ø14/750N POLYETHYLENE PIPE (WIRED)(H.FREE)(FLAME RETARDANT)(ORANGE)	100	mt.	
001 165 310016 00 12	Ø16/750N POLYETHYLENE PIPE (WIRED)(H.FREE)(FLAME RETARDANT)(ORANGE)	100	mt.	
001 165 310018 00 12	Ø18/750N POLYETHYLENE PIPE (WIRED)(H.FREE)(FLAME RETARDANT)(ORANGE)	100	mt.	
001 165 310020 00 12	Ø20/750N POLYETHYLENE PIPE (WIRED)(H.FREE)(FLAME RETARDANT)(ORANGE)	100	mt.	
001 165 310025 00 12	Ø25/750N POLYETHYLENE PIPE (WIRED)(H.FREE)(FLAME RETARDANT)(ORANGE)	100	mt.	
001 165 310032 00 12	Ø32/750N POLYETHYLENE PIPE (WIRED)(H.FREE)(FLAME RETARDANT)(ORANGE)	100	mt.	
001 165 310037 00 12	Ø37/750N POLYETHYLENE PIPE (WIRED)(H.FREE)(FLAME RETARDANT)(ORANGE)	100	mt.	
001 165 310040 00 12	Ø40/750N POLYETHYLENE PIPE (WIRED)(H.FREE)(FLAME RETARDANT)(ORANGE)	100	mt.	
POLYETHYLENE BLACK PIPES (450N)				
001 165 406014 00 11	Ø14/320N POLYETHYLENE PIPE(BLACK)	100	mt.	
001 165 406016 00 11	Ø16/320N POLYETHYLENE PIPE(BLACK)	100	mt.	
001 165 406018 00 11	Ø18/320N POLYETHYLENE PIPE(BLACK)	100	mt.	
001 165 406020 00 11	Ø20/320N POLYETHYLENE PIPE(BLACK)	100	mt.	
001 165 406025 00 11	Ø25/320N POLYETHYLENE PIPE(BLACK)	⊕ ⊗ CE	100	mt.
001 165 406032 00 11	Ø32/320N POLYETHYLENE PIPE(BLACK)	⊕ ⊗ CE	100	mt.
001 165 406037 00 11	Ø37/320N POLYETHYLENE PIPE(BLACK)	⊕ ⊗ CE	100	mt.
001 165 406040 00 11	Ø40/320N POLYETHYLENE PIPE(BLACK)	⊕ ⊗ CE	100	mt.
001 165 406050 00 11	Ø50/320N POLYETHYLENE PIPE(BLACK)	⊕ ⊗ CE	100	mt.
001 165 406063 00 11	Ø63/320N POLYETHYLENE PIPE(BLACK)	⊕ ⊗ CE	100	mt.
001 165 406075 00 11	Ø75/320N POLYETHYLENE PIPE(BLACK)	⊕ ⊗ CE	100	mt.
001 165 406090 00 11	Ø90/320N POLYETHYLENE PIPE(BLACK)	⊕ ⊗ CE	75	mt.
POLYETHYLENE BLACK PIPES (750N)				
001 165 410014 00 11	Ø14/750N POLYETHYLENE PIPE(BLACK)	100	mt.	
001 165 410016 00 11	Ø16/750N POLYETHYLENE PIPE(BLACK)	100	mt.	
001 165 410018 00 11	Ø18/750N POLYETHYLENE PIPE(BLACK)	100	mt.	
001 165 410020 00 11	Ø20/750N POLYETHYLENE PIPE(BLACK)	100	mt.	
001 165 410025 00 11	Ø25/750N POLYETHYLENE PIPE(BLACK)	⊕ ⊗ CE	100	mt.
001 165 410032 00 11	Ø32/750N POLYETHYLENE PIPE(BLACK)	⊕ ⊗ CE	100	mt.
001 165 410037 00 11	Ø37/750N POLYETHYLENE PIPE(BLACK)	⊕ ⊗ CE	100	mt.
001 165 410040 00 11	Ø40/750N POLYETHYLENE PIPE(BLACK)	⊕ ⊗ CE	100	mt.
001 165 410050 00 11	Ø50/750N POLYETHYLENE PIPE(BLACK)	⊕ ⊗ CE	100	mt.
001 165 410063 00 11	Ø63/750N POLYETHYLENE PIPE(BLACK)	⊕ ⊗ CE	100	mt.
001 165 410075 00 11	Ø75/750N POLYETHYLENE PIPE(BLACK)	⊕ ⊗ CE	100	mt.
001 165 410090 00 11	Ø90/750N POLYETHYLENE PIPE(BLACK)	⊕ ⊗ CE	75	mt.
001 165 410100 00 11	Ø100/750N POLYETHYLENE PIPE(BLACK)	⊕ ⊗ CE	50	mt.
001 165 410110 00 11	Ø110/750N POLYETHYLENE PIPE(BLACK)	⊕ ⊗ CE	50	mt.
POLYETHYLENE BLACK PIPES (1250N)				
001 165 412020 00 11	Ø20/1250N POLYETHYLENE PIPE(BLACK)	100	mt.	
001 165 412025 00 11	Ø25/1250N POLYETHYLENE PIPE(BLACK)	100	mt.	
001 165 412032 00 11	Ø32/1250N POLYETHYLENE PIPE(BLACK)	100	mt.	



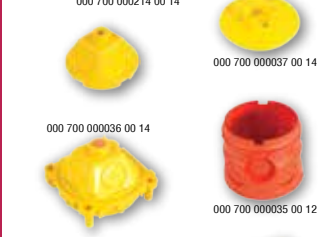

Code	Product Description	Number of Box	Quantity of Pack
PLASTIC BOX-JUNCTION-WEDGES			
126 046 130103	NORM CASE	100 pcs.	1000
126 046 130104	NORM JUNCTION BOXES (14-18 OUTPUT)	50 pcs.	500
126 046 130105	NORM BUAT KAPAKSIZ	50 pcs.	500
001 046 160102 00 11	PLASTIC PLASTIC BOX W.COMBINING TOOL	100 pcs.	400
126 046 130106	PLASTIC DEEP BOX W.COMBINING TOOL	100 pcs.	500
126 046 130107	CLICK-FIT DEEP CASE COVERLESS	100 pcs.	500
001 046 120101 00 11	PLASTER CASE 1 (BLACK)	75 pcs.	300
001 046 120102 00 11	PLASTERBOARD CASE 2 GANG (BLACK)	50 pcs.	200
001 046 120103 00 11	PLASTER CASE 3 LÜ(BLACK)	25 pcs.	100
001 046 120100 00 11	SINGLE PLASTER CASE INTERTWINED BLACK	50 pcs.	300
001 046 170101 00 11	TUNNEL CASE	100 pcs.	500
001 046 170102 00 11	TUNNEL JUNCTION BOX(BLACK)	50 pcs.	300
001 046 000001 00 11	PLASTIC CHOCK (14-18 OUTLET)	100 pcs.	1000
ORANGE COLOUR SQUARE JUNCTION BOXES H.F. (FLAME RETARDANT)			
001 046 131202 00 12	NORM CASE	100 pcs.	1000
001 046 131201 00 12	NORM JUNCTION BOX	50 pcs.	500
001 046 161201 00 12	PLASTIC DEEP BOX	100 pcs.	500
PLASTIC CASE JUNCTION BOXES H.F. (FLAMABLE)(ORANGE)			
001 046 130202 00 12	NORM CASE	100 pcs.	1000
001 046 130201 00 12	NORM JUNCTION BOX	50 pcs.	500
001 046 160201 00 12	PLASTIC DEEP BOX	100 pcs.	500
ORANGE BOX AND JUNCTIONS (FLAME-PROPAGATING)			
001 046 130102 00 12	NORM CASE(ORANGE)	100 pcs.	1000
001 046 130101 00 12	NORM JUNCTION BOX(ORANGE)	50 pcs.	500
001 046 160102 00 12	PLASTIC PLASTIC BOX(ORANGE)W.COMB.TOOL	100 pcs.	400
001 046 160101 00 12	PLAS.DEEP BOX(ORANGE) W.COMBINING TOOL	100 pcs.	500
001 046 170101 00 12	TUNNEL CASE (ORANGE)	100 pcs.	500
001 046 170102 00 12	TUNNEL JUNCTION BOX(ORANGE) H.FREE	50 pcs.	300
001 046 120101 00 12	PLASTER CASE 1 (ORANGE)	75 pcs.	300
001 046 120102 00 12	PLASTER CASE 2 (ORANGE)	50 pcs.	200
001 046 120103 00 12	PLASTER CASE 3 LÜ(ORANGE)	25 pcs.	100
001 046 120100 00 12	SINGLE PLASTER CASE INTERTWINED ORANGE	50 pcs.	300
ORANGE BOX AND JUNCTIONS (NON-FLAME-PROPAGATING)			
001 046 131102 00 12	NORM CASE(ORANGE)(NOFLAME)	100 pcs.	1000
001 046 131101 00 12	CLICK-FIT DEEP CASE (ORANGE) (NOFLAME)	50 pcs.	500
001 046 161102 00 12	PLASTIC PLASTIC BOX(ORANGE)W.COMB.TOOL	100 pcs.	400
001 046 161101 00 12	PLAS.DEEP BOX(ORANGE) W.COMBINING TOOL	100 pcs.	500
001 046 210002 00 12	TUNNEL CASE(NONFLAME)	100 pcs.	500
001 046 210003 00 12	TUNNEL JUNCTION BOX (NONFLAME)	50 pcs.	300
001 046 121101 00 12	PLASTER CASE 1 (ORANGE) FR	75 pcs.	300
001 046 121102 00 12	PLASTER CASE 2 (ORANGE)FR	50 pcs.	200
001 046 121103 00 12	PLASTER CASE 3 LÜ(ORANGE)	25 pcs.	100
001 046 121100 00 12	SINGLE PLASTER CASE INTERWINED (ORANGE)	50 pcs.	300
CONCRETE WALL SWITCH BOXES (FLAME-PROPAGATING)			
000 700 000037 00 14	CONCRETE JUNCTION BOX BACK COVER(YELLOW)	50 pcs.	500
000 700 000035 00 12	JUNCTION BOX BODY(60)(ORANGE)H.FREE	50 pcs.	350
000 700 000256 00 14	MOULD FIXING TOOL(YELLOW)H.FREE		250
000 700 000039 00 12	SWITCH BOX (ORANGE)H.FREE	100 pcs.	500
000 700 000036 00 14	CONIC BODY(YELLOW)H.FREE	50 pcs.	250
000 700 000214 00 14	WALL LAMP CASE 20 YELLOW	100 pcs.	1000
000 700 000215 00 12	BRACKET LAMP SCARF JOINT BRACKET (ORANGE) H.FREE	100 pcs.	1000
CONCRETE WALL SWITCH BOXES (NON-FLAME-PROPAGATING)			
000 700 200037 00 14	JUNCTION BOX BACK COVER YELLOW (NON FLAME)	50 pcs.	500
000 700 200035 00 12	CONCRETE JUNCTION BOX BODY ORANGE 60 MM (NON FLAME)	50 pcs.	350
000 700 200256 00 14	FASTANER MOLD YELLOW (NON FLAME)		250
000 700 200039 00 12	SHALLOW GROSS SWITCH CASE ORANGE (NON FLAME)	100 pcs.	500
000 700 200036 00 14	CONICAL BODY YELLOW (NON FLAME)	50 pcs.	250
000 700 200214 00 14	WALL LAMP CASE 20 YELLOW	100 pcs.	1000
000 700 200215 00 12	BRACKET LAMP SCARF JOINT BRACKET ORANGE (NON FLAME)	100 pcs.	1000
SQUARE JUNCTION			
001 046 021010 00 11	SQUARE JUNCTION BOX(10X10) BLACK	10 pcs.	300
001 046 021212 00 11	SQUARE JUNCTION BOX(12X12) BLACK	10 pcs.	200
001 046 021515 00 11	SQUARE JUNCTION BOX(15X15) BLACK	10 pcs.	120
001 046 022020 00 11	SQUARE JUNCTION BOX(20X20) BLACK	10 pcs.	70
001 046 000103 00 11	S.MOUNTED JUNCTION BOX 3 PLASTIC(BLACK)	10 pcs.	240
001 046 000104 00 11	S.MOUNTED JUNCTION BOX 4 PLASTIC(BLACK)	10 pcs.	240
001 046 000103 00 00	S.MOUNTED JUNCTION BOX 3 PLASTIC(WHITE)	10 pcs.	240
001 046 000104 00 00	S.MOUNTED JUNCTION BOX 4 PLASTIC(WHITE)	10 pcs.	240

Code	Product Description	Number of Box	Quantity of Pack
------	---------------------	---------------	------------------

ORANGE SQUARE JUNCTION

001 046 021010 00 12	SQUARE JUNCTION BOX ORANGE(10X10) H.FREE	10 pcs.	300
001 046 021212 00 12	SQUARE JUNCTION BOX ORANGE(12X12) H.FREE	10 pcs.	200
001 046 021515 00 12	SQUARE JUNCTION BOX ORANGE(15X15) H.FREE	10 pcs.	120
001 046 022020 00 12	SQUARE JUNCTION BOX ORANGE(20X20) H.FREE	10 pcs.	70
001 046 000103 00 12	S.MOUNTED JUNCTION BOX 3 PLASTIC H.FREE	10 pcs.	240
001 046 000104 00 12	S.MOUNTED JUNCTION BOX 4 PLASTIC H.FREE	10 pcs.	240

ORANGE SQUARE JUNCTION (NON-FLAME-PROPAGATING)



001 046 051010 00 12	SQUARE JUNCTION BOX NONFLAM.ORANGE 10X10	10 pcs.	300
001 046 051212 00 12	SQUARE JUNCTION BOX NONFLAM.ORANGE 12X12	10 pcs.	200
001 046 051515 00 12	SQUARE JUNCTION BOX NONFLAM.ORANGE 15X15	10 pcs.	120
001 046 052020 00 12	SQUARE JUNCTION BOX NONFLAM.ORANGE 20X20	10 pcs.	70

LUXURY JUNCTION COVERS

126 046 180001	LUX CASE LID(CONVEX-PLAS.FOOT)	100 pcs.	1000
126 046 180003	LUX CASE LID(FLAT-PLASTIC AYAK)	100 pcs.	1000
126 046 180004	LUX CASE LID(CONVEX.PLAS.FOOT)SCREW	100 pcs.	1000

SQUARE JUNCTION COVERS

000 700 000043 00 00	10X10 SQUARE JUNCTION COVER	1 pcs.	300
000 700 000045 00 00	12X12 SQUARE JUNCTION COVER	1 pcs.	200
000 700 000047 00 00	15X15 SQUARE JUNCTION COVER	1 pcs.	200
000 700 000049 00 00	20X20 SQUARE JUNCTION COVER	1 pcs.	100

CONCRETE NAIL CROCHET

032 048 070000	NO:0 CONCRETE NAILED CROCHET	1000pcs.	30000
032 048 070001	NO:1 CONCRETE NAILED CROCHET	1000pcs.	30000
032 048 070002	NO:2 CONCRETE NAILED CROCHET	1000pcs.	20000
032 048 070003	NO:3 CONCRETE NAILED CROCHET	1000pcs.	20000
032 048 070004	NO:4 CONCRETE NAILED CROCHET	1000pcs.	20000
032 048 070005	NO:5 CONCRETE NAILED CROCHET	1000pcs.	10000
032 048 070006	NO:6 CONCRETE NAILED CROCHET	1000pcs.	10000
032 048 070007	NO:7 CONCRETE NAILED CROCHET	1000pcs.	8000
032 048 070008	NO:8 CONCRETE NAILED CROCHET	600pcs.	5000

GALVANIZED SHEET CROCHET

001 048 060001 00 00	GALVANIZE CROCHET(SING.)(12) (NO:1)	1500pcs.	
001 048 060002 00 00	GALVANIZE CROCHET(SING.)(14) (NO:2)	1000pcs.	
001 048 060003 00 00	GALVANIZE CROCHET(SING.)(17) (NO:3)	700pcs.	
001 048 060004 00 00	GALVANIZE CROCHET(SING.)(20) (NO:4)	500pcs.	
001 048 060007 00 00	GALVANIZE CROCHET(SING.)(26) (NO:7)	350pcs.	
001 048 060008 00 00	GALVANIZE CROCHET(SING.)(34) (NO:8)	250pcs.	
001 048 060009 00 00	GALVANIZE CROCHET(SING.)(43) (NO:9)	200pcs.	
001 048 060010 00 00	GALVANIZE CROCHET(SING.)(53) (NO:10)	150pcs.	
001 048 060011 00 00	GALVANIZE CROCHET(SING.)(53) (NO:11)	120pcs.	
001 048 070002 00 00	GALVANIZE CROCHET(DOUBLE)13) (NO:2)	600pcs.	
001 048 070003 00 00	GALVANIZE CROCHET(DOUBLE)(16) (NO:3)	500pcs.	
001 048 070004 00 00	GALVANIZE CROCHET(DOUBLE)(22 K) (NO:4)	400pcs.	
001 048 070007 00 00	GALVANIZE CROCHET(DOUBLE)(25) (NO:7)	400pcs.	
001 048 070008 00 00	GALVANIZE CROCHET(DOUBLE)(35) (NO:8)	300pcs.	
001 048 070009 00 00	GALVANIZE CROCHET(DOUBLE)(45) (NO:9)	200pcs.	
001 048 070010 00 00	GALVANIZE CROCHET(DOUBLE)(50)(NO:10)	150pcs.	
001 048 070011 00 00	GALVANIZE CROCHET(DOUBLE)(55)(NO:11)	100pcs.	

PLASTİK DÜBELLER

016 053 000014	SHEATHING SCREW ANCHOR	100 pcs.	10000
001 053 000001 00 00	SCREW ANCHOR PLASTER (WHITE) 2MM	100 pcs.	15000
001 053 000002 00 00	TRUNKING SCREW ANCHOR	1000pcs.	14000
016 053 000006	6 MM WHITE DOWEL	1000pcs.	35000
016 053 000007	SCREW ANCHOR 7 (WHITE)	1000pcs.	25000
016 053 000008	8 MM WHITE DOWEL	1000pcs.	20000

RAWLPLUG CROCHETS

001 048 090002 00 17	CABLE CROCHET(3/13)(1)(GRAY)	500 pcs.	10000
001 048 090006 00 17	CABLE CROCHETS(8/28)(1)(GRAY)	500 pcs.	5000
001 048 090001 00 00	PIPE CROCHETS	100 pcs.	2500
001 048 090003 00 17	PIPE CROCHETS(16 K)(GRAY)	100 pcs.	2000
001 048 090004 00 17	PIPE CROCHETS(20)(GRAY)	100 pcs.	1500
001 048 090005 00 17	PIPE CROCHETS(25)(GRAY)	100 pcs.	1000

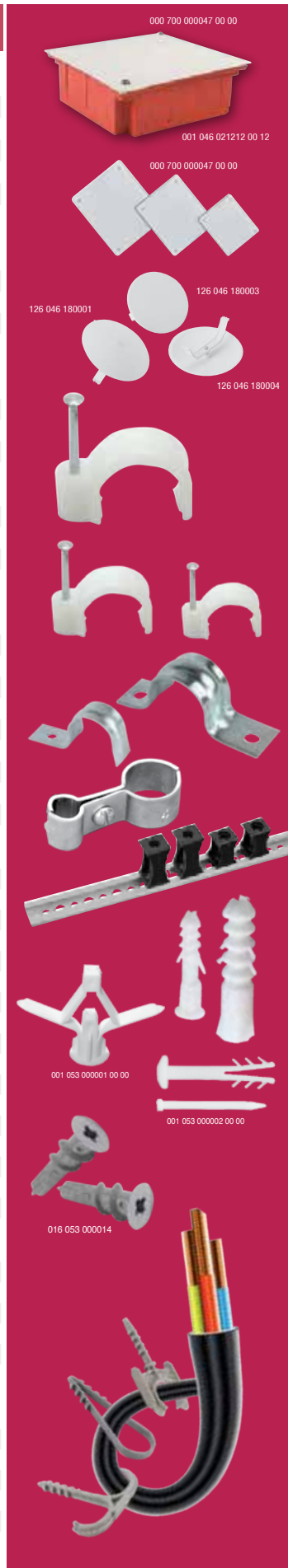



Code	Product Description	Number of Box	Quantity of Pack
------	---------------------	---------------	------------------

SMART DOOR LOCK

027 112 000010	SMART DOOR LOCK		
027 112 000011	DOOR CONTROL SYSTEM (500 MEMORY KEYS)		
027 112 000012	DOOR CONTROL SYSTEM (1000 MEMORY KEYS)		

DOOR AND STAIR CHECK

027 112 000001	DOOR AUTOMATION (TOUCHING)	1 pcs.	20
027 112 000002	DOOR AUTOMATION (PRESSING)	1 pcs.	20
027 112 000007	ELEC.LOCK (SWITCH) DOOR AUTOMATION	1 pcs.	12
027 112 000009	ELECTRICAL DOOR AUTOMATION WITH BALL-BEARING	1 pcs.	12
027 112 000003	DOOR AUTOMATION WITH BUTTON	1 pcs.	30
028 112 000004	DOOR CHECK (NORMAL)	1 pcs.	30
027 112 000005	STAIRS AUTOMATION WITH RAIL	1 pcs.	30
027 112 000006	STAIRS AUTOMATION WITH NORMAL	1 pcs.	30

RING BUTTON VARIOUS

037 106 000005	PLASTIC BELL BUTTON 1 LINE	1 pcs.	40 pcs.
037 106 020001	ALUMINIUM BELL BUTTON 1 LINE	1 pcs.	
037 106 020002	ALUMINIUM BELL BUTTON 2 LINE	1 pcs.	
037 106 020003	ALUMINIUM BELL BUTTON 3 LINE	1 pcs.	
037 106 020004	ALUMINIUM BELL BUTTON 4 LINE	1 pcs.	
037 106 020005	ALUMINIUM BELL BUTTON 5 LINE	1 pcs.	
037 106 020006	ALUMINIUM BELL BUTTON 6 LINE	1 pcs.	
037 106 020007	ALUMINIUM BELL BUTTON 7 LINE	1 pcs.	
037 106 020008	ALUMINIUM BELL BUTTON 8 LINE	1 pcs.	
037 106 020009	ALUMINIUM BELL BUTTON 9 LINE	1 pcs.	
037 106 020010	ALUMINIUM BELL BUTTON 10 LINE	1 pcs.	

RING AND TRANSFORMER

027 105 010012	BELL TRANSFORMER 12V	1 pcs.	80
027 105 010015	BELL TRANSFORMER 15V	1 pcs.	40
028 105 020003	220V SCHOOL FACTORY BELL	1 pcs.	24
028 105 020004	DRUM 12-24-110 V	1 pcs.	24
028 105 020000	BELL RELAY	1 pcs.	100
018 105 000006	DOOR BELL (BIRD PIPE) SINGLE TONE	1 pcs.	50
018 105 000007	DOOR BELL (BIRD PIPE) THREE TONES	1 pcs.	50
018 105 000001	TELEPHONE RING	1 pcs.	50
018 105 000002	DOOR BELL DING DONG (ELECTRONIC)	1 pcs.	50
018 105 000003	DOOR BELL DING DONG (MECHANIC)	1 pcs.	20
018 105 000004	DOOR BELL TALKING	1 pcs.	30

PHONE DISTRIBUTION BOXES AND ACCESSORIES

001 049 001020 00 17	PHONE DISTRIBUTION BOX(10-20)PLS.(LOCK)	☞ ☞	2 pcs.	60
001 049 011020 00 17	PHONE DISTRIBUTION BOX(10-20)(LOCK)	☞ ☞	2 pcs.	60
001 049 001050 00 17	PHONE DISTRIBUTION BOX(10-50)PLS.(LOCK)	☞ ☞	1 pcs.	28
001 049 011050 00 17	PHONE DISTRIBUTION BOX(10-50)(LOCK)	☞ ☞	1 pcs.	28
001 049 211050 00 17	PHONE DISTRIBUTION BOX(10-50)(LOCK)(NOFLAME)		1 pcs.	28
001 024 000001 00 00	FRAME (1 MODULE)		1 pcs.	1000
001 024 000002 00 00	FRAME (2 MODULE)		1 pcs.	500
001 024 000003 00 00	FRAME (3 MODULE)		1 pcs.	400
001 024 000004 00 00	FRAME (4 MODULE)		1 pcs.	300
001 024 000005 00 00	FRAME (5 MODULE)		1 pcs.	200
001 024 000010 00 00	FRAME (10 MODULE)		1 pcs.	100
888 049 050001	10 PAIRS CONNECTION MODULE		10 pcs.	250
888 049 050002	10 PAIRS DISCONNECTION MODULE		10 pcs.	250
888 049 050003	INTERPRETATION TOOL		1 pcs.	50



CODE
888 038 218000
DESCRIPTION
Q218 WIRELESS DOORBELL
100 MT. 32 SOUND
PACKAGE
1 Pcs. / 10



CODE
888 038 007000
DESCRIPTION
007-D DOOR / WINDOW
ALARM 2 SOUND
PACKAGE
1 Pcs. / 10



CODE
888 038 008000
DESCRIPTION
008-C LED WITH SENSOR
ALR. DOOR BELL 32M. -8 MT
PACKAGE
1 Pcs. / 10



CODE
018 105 114800
DESCRIPTION
A-148 DOOR BELL
(32 SOUND))
PACKAGE
1 Pcs. / 10



CODE
018 105 158100
DESCRIPTION
X-581 DOOR BELL
(32 SOUND)
PACKAGE
1 Pcs. / 10



CODE
018 105 162800
DESCRIPTION
WA-628 DOOR BELL
(32 SOUND)WHITE
PACKAGE
1 Pcs. / 10



CODE
018 105 162811
DESCRIPTION
WA-628 DOOR BELL
(32 SOUND) BLACK
PACKAGE
1 Pcs. / 10



CODE
018 105 163800
DESCRIPTION
WA-638 DOOR BELL
(32 SOUND) WHITE
PACKAGE
1 Pcs. / 10



CODE
018 105 163811
DESCRIPTION
WA-638 DOOR BELL
(32 SOUND) BLACK
PACKAGE
1 Pcs. / 10

FIRA ALARM AND WARNING SYSTEM & WAARNING HORN



LED

FLASHING & ROTATING

DOUBLE FUNCTIONAL



NEW

WARNING HORN

026 112 010001	WARNING HORN 220 V	1 pcs.	45 pcs.
028 120 000001	WARNING BUTTON (SQUARE)	2 pcs.	90 pcs.

ALARM HORN AND FIRE WARNING BUTTON

010 090 050050	FIRE ALARM PUSH BUTTON	2 pcs.	
010 090 050051	FIRE ALARM PUSH BUTTON WITH COVER	1 pcs.	
028 120 010006	ALARM BUZZER PLASTIC	1 pcs.	
028 120 010005	ALARM BUZZER METAL	1 pcs.	

ROTATING BEACON FLASHER SIREN REFCONDUCT

001 111 020006 00 00	LED DOUBLE FUNCTIONAL WARNING LAMP 220 V	1 pcs.	
001 111 020004 00 00	ROTATING LAMP 220 V AC	1 pcs.	
001 111 020001 00 00	SWIVEL LAMP 12 V AC	1 pcs.	
001 111 020002 00 00	SWIVEL LAMP 24 V AC	1 pcs.	
001 111 030003 00 00	FLASHING WARNING LAMP 220 V	1 pcs.	
026 111 020005	12 V.DC.MAGNET ROTATING LAMP(FOR CAR)	1 pcs.	
102 111 000012	LED FLASHING ELECTRONIC SIREN 12V	1 pcs.	
102 111 000024	LED FLASHING ELECTRONIC SIREN 24V	1 pcs.	
102 111 010020	LED FLASHING ELECTRONIC SIREN 220V	1 pcs.	
026 111 000001	PLANE WARNING LAMP (WITH LAMP)	1 pcs.	
026 111 000002	PLANE WARNING LAMP STAND	1 pcs.	
888 111 050004	MS190 SMALL MOTOR SIREN	1 pcs.	
026 111 010001	AS.1 SIREN W.MOTOR (PLAS.BODY)220V 150W	1 pcs.	
026 111 010002	AS.2 SIREN W.MOTOR (PLAS.BODY)220V,200W	1 pcs.	
026 111 010003	AS.1 SIREN W.MOTOR (METAL BODY)220V,150W	1 pcs.	€€
026 111 010004	AS.2 SIREN W.MOTOR (METAL BODY)220V,200W	1 pcs.	€€
026 111 010005	AS.3 SIREN W.MOTOR 220V-280W	1 pcs.	€€



NEW

MUTLUSAN FANS





100 mm CE

Operation Voltage 220-240V / 50-60Hz

Airflow 100m³/h

Round Speed 2250 rpm

Power 12W

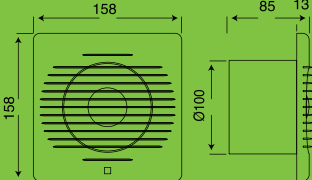

Code : 001 111 000100 00 00
Description : MUTLUSAN 100 FAN
Package : 1/20



120 mm CE

Operation Voltage 220-240V / 50-60Hz

Airflow 120m³/h

Round Speed 1900 rpm

Power 15W

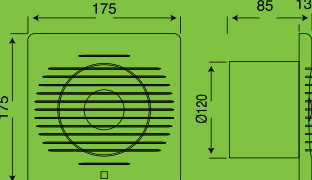

Code : 001 111 000120 00 00
Description : MUTLUSAN 120 FAN
Package : 1/20



150 mm CE

Operation Voltage 220-240V / 50-60Hz

Airflow 150m³/h

Round Speed 1800 rpm

Power 20W

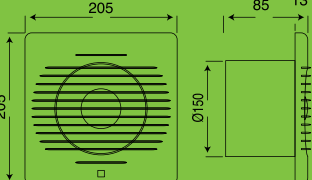

Code : 001 111 000150 00 00
Description : MUTLUSAN 150 FAN
Package : 1/20



200 mm CE

Operation Voltage 220-240V / 50-60Hz

Airflow 200m³/h

Round Speed 2000 rpm

Power 40W

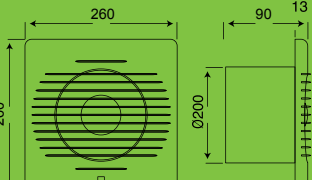

Code : 001 111 000200 00 00
Description : MUTLUSAN 200 FAN
Package : 1/8

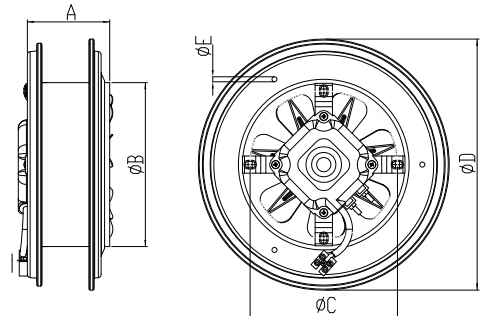
MUTLUSAN FANS

CODE	DESCRIPTION	Watt	SPEED	A	B	C	D	E	PCS
080 088 160160	MB160MM FAN	25	1450	82	162	148	236	5	1
080 088 160200	MB200MM FAN	28	1250	82	202	178	282	5	1
080 088 160250	MB250MM FAN	48	1450	82	248	234	332	5	1
080 088 160300	MB300MM FAN	50	1350	82	298	284	380	5	1

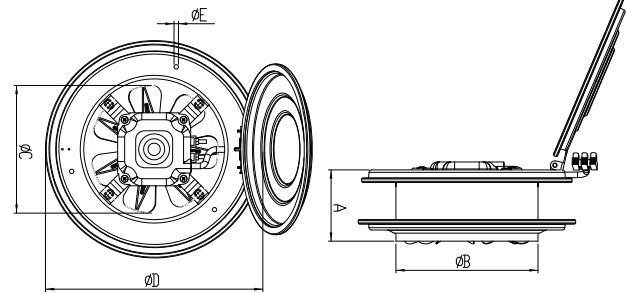

CODE	DESCRIPTION	Watt	SPEED	A	B	C	D	E	PCS
080 088 200160	MK160MM FAN WITH COVER	25	1450	100	162	148	236	5	1
080 088 200200	MK200MM FAN WITH COVER	28	1250	100	202	178	282	5	1
080 088 200250	MK250MM FAN WITH COVER	48	1450	100	248	234	332	5	1
080 088 200300	MK300MM FAN WITH COVER	50	1350	100	298	284	380	5	1

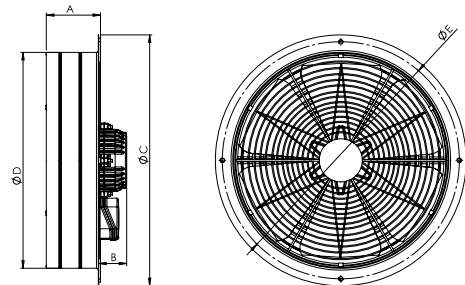

CODE	DESCRIPTION	Watt	SPEED	A	B	C	D	E	PCS
080 088 002250	MSM250-2K MONOPHASE IND. TYPE FAN	150/190	2900/3250	114	61	304	251	277	1
080 088 000250	MSM250 MONOPHASE IND. TYPE FAN	65/75	1475/1770	114	61	304	251	277	1
080 088 000300	MSM300 MONOPHASE IND. TYPE FAN	90/110	1445/1700	114	61	390	325	360	1
080 088 000350	MSM350 MONOPHASE IND. TYPE FAN	160	1460/1750	114	61	435	374	405	1
080 088 000400	MSM400 MONOPHASE IND. TYPE FAN	185	1425/1725	114	61	485	427	455	1
080 088 000450	MSM450 MONOPHASE IND. TYPE FAN	200/190	1430/1730	114	61	546	470	516	1
080 088 000500	MSM500 MONOPHASE IND. TYPE FAN	230	1440/1700	125	61	590	518	560	1
080 088 000550	MSM550 MONOPHASE IND. TYPE FAN	220/320	1440/1700	130	160	624	560	595	1
080 088 000600	MSM600 MONOPHASE IND. TYPE FAN	235/340	1400/1670	130	160	674	610	645	1

CODE	DESCRIPTION	Watt	SPEED	A	B	C	D	E	PCS
080 088 102250	MST250-2K TRIPHASE IND. TYPE FAN	110/140	2900/3250	114	61	304	251	277	1
080 088 100250	MST250 TRIPHASE IND. TYPE FAN	50/60	1475/1770	114	61	304	251	277	1
080 088 100300	MST300 TRIPHASE IND. TYPE FAN	70/85	1445/1700	114	61	390	325	360	1
080 088 100350	MST350 TRIPHASE IND. TYPE FAN	120	1460/1750	114	61	435	374	405	1
080 088 100400	MST400 TRIPHASE IND. TYPE FAN	150	1425/1725	114	61	485	427	455	1
080 088 100450	MST450 TRIPHASE IND. TYPE FAN	170/200	1430/1730	114	61	546	470	516	1
080 088 100500	MST500 TRIPHASE IND. TYPE FAN	200	1440/1700	125	61	590	518	560	1
080 088 100550	MST550 TRIPHASE IND. TYPE FAN	220/320	1440/1700	130	160	624	560	595	1
080 088 100600	MST600 TRIPHASE IND. TYPE FAN	235/340	1400/1670	130	160	674	610	645	1

LED



EMERGENCY LIGHTINGS



EXIT - TRANSPARENT EMERGENCY LIGHTING LUMINARIE (LED) IP20 CE

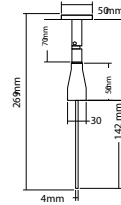
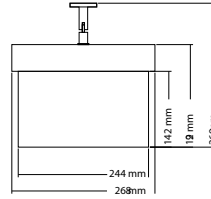

102 038 0008XX - CEXA

* BODY: ABS

* GLASS: Connected to Polystyrene (PS) or Acrylic (PMMA) or Polycarbonate (PC)

* PRINTING: Acrylic Light Permeable Translucent Foil

* OPERATION: continuous operation in the network and Emergency

* BATTERY: 3.6V 80mAH NiMH (NickelMethalhydride)

* CHARGE TIME: 14-20 Hours





























































* DISCHARGE TIME: 60 Min. Or optional 180 Min.

* PROTECTION CLASS: IP20

* LED: 4.8mm 6000K White Led

or 2835 6400K EDISON OPTO SMD Led

CONSUMPTION: 2 Watts

							
01	02	03	04	05	06	07	08
							
09	10	11	12	13	14		
							
15	16	17	18	19	20		
							
21	22	23	24	25	26		
							
27	28	29	30	31	32		
							
33	34	35	36				
							
37	38	39	40	41	42	43	
							
44	45	46	47	48	49	50	51
							
52	53	54	55	56	57	58	59
							
60	61	62	63	64	65		

*PLEASE DO NOT FORGET TO WRITE DOWN THE PRODUCT'S SYMBOL COLORS YOU ORDERED.

*THE LAST TWO DIGITS OF THE PRODUCT CODE XX NUMBERS INDICATE THE PRODUCT'S SYMBOL CODE.

New

LED BULKHEAD LIGHTING FIXTURE



PRODUCT COD
016 038 701100
DESCRIPTION
LEDLIGHT-1 LED LUMINAIRE (WHITE)
LÜMEN / WATT
15W / 1500Lm
KELVİN
6400K
PACKAGE
30



PRODUCT COD
016 038 701111
DESCRIPTION
LEDLIGHT-1 LED LUMINAIRE (BLACK)
LÜMEN / WATT
15W / 1500Lm
KELVİN
6400K
PACKAGE
30

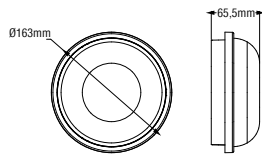

PRODUCT COD
016 038 701200
DESCRIPTION
LEDLIGHT-2 LED LUMINAIRE (WHITE)
LÜMEN / WATT
20W / 2000Lm
KELVİN
6400K
PACKAGE
20



PRODUCT COD
016 038 701211
DESCRIPTION
LEDLIGHT-2 LED LUMINAIRE (BLACK)
LÜMEN / WATT
20W / 2000Lm
KELVİN
6400K
PACKAGE
20

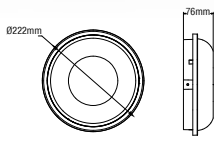
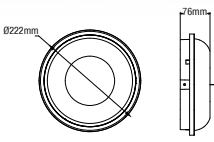

PRODUCT COD
016 038 701300
DESCRIPTION
LEDLIGHT-3 LED LUMINAIRE (WHITE)
LÜMEN / WATT
20W / 2000Lm
KELVİN
6400K
PACKAGE
30



PRODUCT COD
016 038 701311
DESCRIPTION
LEDLIGHT-3 LED LUMINAIRE (BLACK)
LÜMEN / WATT
20W / 2000Lm
KELVİN
6400K
PACKAGE
30

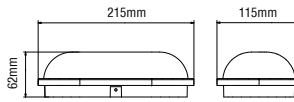
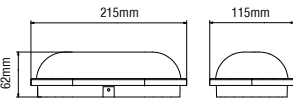

PRODUCT COD
016 038 701400
DESCRIPTION
LEDLIGHT-4 LED LUMINAIRE (WHITE)
LÜMEN / WATT
20W / 2000Lm
KELVİN
6400K
PACKAGE
20



PRODUCT COD
016 038 701411
DESCRIPTION
LEDLIGHT-4 LED LUMINAIRE (BLACK)
LÜMEN / WATT
20W / 2000Lm
KELVİN
6400K
PACKAGE
20

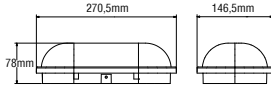

PRODUCT COD
016 038 701500
DESCRIPTION
LED GLOP ARMATÜR (BEYAZ) IP20
LÜMEN / WATT 20W / 1550 Lm
KELVİN 6400
PACKAGE 24



PRODUCT COD
016 038 701522
DESCRIPTION
LED GLOP ARMATÜR (KROM) IP20
LÜMEN / WATT 20W / 1550 Lm
KELVİN 6400
PACKAGE 24

BULKHEAD LIGHTING FIXTURE

PRODUCT COD
016 038 250020
DESCRIPTION
LAMP HOLDER AND
HANGING SET (PLASTIC)
PACKAGE
50/300



PRODUCT COD
001 038 250022 00 00
DESCRIPTION
360° SENSOR CEILING GLOBE
FITTURE (2X25 W)
PACKAGE
12



PRODUCT COD
001 038 250018 00 00
DESCRIPTION
LAMP HOLDER AND
HANGING SET
PACKAGE
25/300



PRODUCT COD
001 038 250021 00 00
DESCRIPTION
360° SENSOR CEILING GLOBE
FITTURE (2X25 W)
PACKAGE
10



PRODUCT COD
001 038 250016 00 00
DESCRIPTION
DAISY
LAMP HOLDER
PACKAGE
25/275



PRODUCT COD
078 039 500100
DESCRIPTION
QUEEN WALL LAMP WITH
LAMP HOLDER
PACKAGE
20



PRODUCT COD
001 038 250017 00 00
DESCRIPTION
BIG DAISY
LAMP HOLDER
PACKAGE
10/80

GLASS BULKHEAD LIGHTING FIXTURE



CE

PRODUCT COD
016 038 250031
DESCRIPTION
CEILING GLOBE LIGHTING
FIXT. (MINI) 75
PACKAGE
48



CE

PRODUCT COD
016 038 250028
DESCRIPTION
OVAL ANTIGRON
LIGHTING FIXTURE
PACKAGE



Max: 60W



CE

PRODUCT COD
001 038 120101 00 00
DESCRIPTION
ORKIDE LIGHTING
FIXTURE WHITE
PACKAGE
48



CE

PRODUCT COD
016 038 250029
DESCRIPTION
PROTECTED OVAL
ANTIGRON LIG. FIXTURE
PACKAGE
48



Max: 60W



CE

PRODUCT COD
001 038 160101 00 00
DESCRIPTION
YONCA LIGHTING
FIXTURE WHITE
PACKAGE
16



CE

PRODUCT COD
001 038 150101 00 00
DESCRIPTION
BEGONYA LIGHTING FIXTURE
CLASSIC WHITE IP54
PACKAGE
12



Max: 60W



CE

PRODUCT COD
016 038 250013
DESCRIPTION
WALL LAMP QUEEN

PACKAGE
12/48



CE

PRODUCT COD
001 038 130101 00 00
DESCRIPTION
BEGONYA LIGHTING FIXTURE
VERTICAL WHITE IP54
PACKAGE
12



Max: 60W



PRODUCT COD
078 039 100005
DESCRIPTION
NERGİS WALL LAMP
QUEEN
PACKAGE
8/64



CE

PRODUCT COD
001 038 140101 00 00
DESCRIPTION
BEGONYA LIGHTING FIX.
HORIZONTAL WHITE IP54
PACKAGE
12



Max: 60W



BULKHEAD LIGHTING FIXTURE



PRODUCT COD
016 038 411100
DESCRIPTION
WALL FIXTURE ANTIGRON
(IP54) WHITE
PACKAGE
1/20

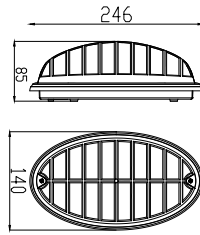

PRODUCT COD
016 038 411111
DESCRIPTION
WALL FIXTURE ANTIGRON
(IP54) WHITE
PACKAGE
1/20



PRODUCT COD
016 038 411300
DESCRIPTION
FIXTURE ANTIGRON (IP54)
WHITE
PACKAGE
1/24

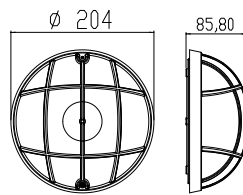

PRODUCT COD
016 038 411311
DESCRIPTION
FIXTURE ANTIGRON (IP54)
WHITE
PACKAGE
1/24



PRODUCT COD
016 038 410600
DESCRIPTION
LIGHTING FIXTURE
CREAM
PACKAGE
1/10

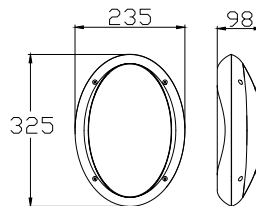

PRODUCT COD
016 038 410611
DESCRIPTION
LIGHTING FIXTURE
WHITE
PACKAGE
1/10



PRODUCT COD
016 038 410500
DESCRIPTION
LIGHTING FIXTURE
(IP65)CREAM
PACKAGE
1/10

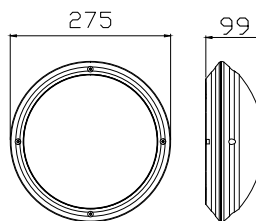

PRODUCT COD
016 038 410511
DESCRIPTION
LIGHTING FIXTURE
(IP65)WHITE
PACKAGE
1/10



PRODUCT COD
016 038 410800
DESCRIPTION
LIGHTING FIXTURE
(IP65)WHITE
PACKAGE
1/16

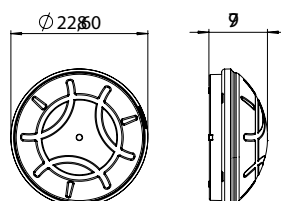

PRODUCT COD
016 038 410811
DESCRIPTION
LIGHTING FIXTURE
(IP65)WHITE
PACKAGE
1/16





BULKHEAD LIGHTING FIXTURE



PRODUCT COD
016 038 700100
DESCRIPTION
OPAK LIGHTING FIXTURE
(IP54) WHITE
PACKAGE
1/16



Max: 20W

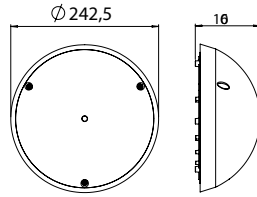

PRODUCT COD
016 038 700111
DESCRIPTION
OPAK LIGHTING FIXTURE
(IP54) WHITE
PACKAGE
1/16



Max: 20W



PRODUCT COD
016 038 700200
DESCRIPTION
TRANSPARENT LIGHTING
FIXTURE (IP54) WHITE
PACKAGE
1/16



Max: 20W

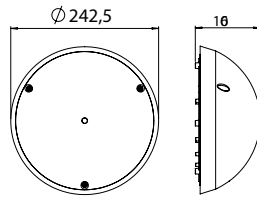

PRODUCT COD
016 038 700211
DESCRIPTION
TRANSPARENT LIGHTING
FIXTURE (IP54) WHITE
PACKAGE
1/16



Max: 20W



PRODUCT COD
016 038 700300
DESCRIPTION
OPAK WALL LAMP
(IP54) WHITE
PACKAGE
1/20



Max: 20W

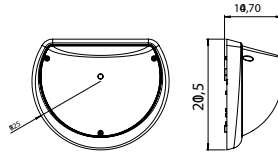

PRODUCT COD
016 038 700311
DESCRIPTION
OPAK WALL LAMP
(IP54) WHITE
PACKAGE
1/20



Max: 20W



PRODUCT COD
016 038 700400
DESCRIPTION
TRANSPARENT LIGHTING
FIXTURE (IP54) WHITE
PACKAGE
1/20



Max: 20W

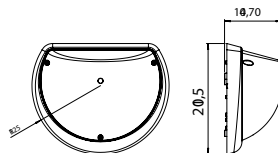

PRODUCT COD
016 038 700411
DESCRIPTION
TRANSPARENT LIGHTING
FIXTURE (IP54) WHITE
PACKAGE
1/20



Max: 20W

BULKHEAD LIGHTING FIXTURE



PRODUCT COD
001 038 020201 00 00
DESCRIPTION
FULYA WALL LAMP WHITE
PACKAGE
2/20



PRODUCT COD
001 038 090101 00 00
DESCRIPTION
YASEMIN WALL LAMP WHITE
PACKAGE
2/24



PRODUCT COD
001 038 010201 00 00
DESCRIPTION
MANOLYA WALL LAMP WHITE
PACKAGE
2/20

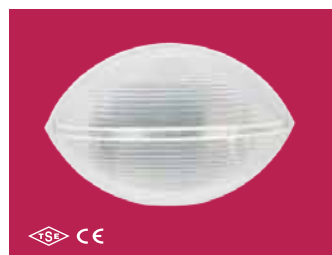

PRODUCT COD
001 038 080101 00 00
DESCRIPTION
YASEMIN LIGHTING FIXTURE
PACKAGE
2/24



BULKHEAD LIGHTING FIXTURE

PRODUCT COD
001 038 050101 00 00
DESCRIPTION
YASEMIN UFO GLOBE
LIGHTING FIXTURE WHITE
PACKAGE
12



PRODUCT COD
078 039 100006
DESCRIPTION
CEILING TYPE LIGHTING
FIX(DOUBLE LAMP HOLDER)
PACKAGE
2/32



PRODUCT COD
001 038 070101 00 00
DESCRIPTION
YASEMIN UFO GLOBE
LIGHTING FIXTURE WHITE
PACKAGE
12



PRODUCT COD
001 038 010101 00 00
DESCRIPTION
MANOLYA LIGHTING
FIXTURE WHITE
PACKAGE
5



PRODUCT COD
001 038 040101 00 00
DESCRIPTION
YASEMIN UFO LIGHTING
FIXTURE WHITE
PACKAGE
12



PRODUCT COD
001 038 020101 00 00
DESCRIPTION
FULYA LIGHTING FIXTURE
WHITE
PACKAGE
5



PRODUCT COD
001 038 060101 00 00
DESCRIPTION
YASEMIN GLOBE LIGHTING
FIXTURE WHITE
PACKAGE
12



PRODUCT COD
001 038 180101 00 00
DESCRIPTION
AKASYA LIGHTING FIXTURE
WHITE
PACKAGE
5



PRODUCT COD
001 038 030101 00 00
DESCRIPTION
YASEMIN FLAT LIGHTING
FIXTURE WHITE
PACKAGE
12

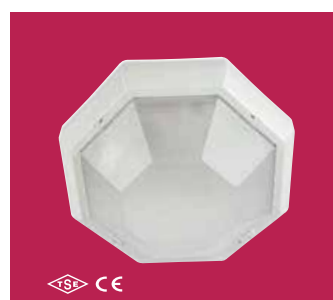

PRODUCT COD
001 038 170101 00 00
DESCRIPTION
KAMELYA LIGHTING
FIXTURE WHITE
PACKAGE
5

GARDEN LIGHTING 



PRODUCT COD
016 038 010116

DESCRIPTION
FLORA GARDEN
LIGHTING
(BLACK)

PACKAGE
1/12



PRODUCT COD
016 038 010117

DESCRIPTION
FLORA GARDEN
LIGHTING BRACKET
(BLACK)

PACKAGE
1/12



PRODUCT COD
016 038 412011

DESCRIPTION
FLORA GARDEN
LIGHTING CEILING
TYPE (BLACK)

PACKAGE
1/12



PRODUCT COD
016 038 412111

DESCRIPTION
FLORA GARDEN
LIGHTING BRACKET
(BLACK)

PACKAGE
1/20



PRODUCT COD
016 038 020116

DESCRIPTION
FLORA GARDEN
LIGHTING
(WHITE)

PACKAGE
1/12



PRODUCT COD
016 038 020117

DESCRIPTION
FLORA GARDEN
LIGHTING BRACKET
(WHITE)

PACKAGE
1/12



PRODUCT COD
016 038 412000

DESCRIPTION
FLORA GARDEN
LIGHTING CEILING
TYPE (WHITE)

PACKAGE
1/12



PRODUCT COD
016 038 412100

DESCRIPTION
FLORA GARDEN
LIGHTING BRACKET
(WHITE)

PACKAGE
1/20



PRODUCT COD
016 038 010120

DESCRIPTION
GARDEN LONG
FLOOR LIGHTING
(BLACK)

PACKAGE
1/8

542,3mm

Ø151,8



PRODUCT COD
016 038 010118

DESCRIPTION
GARDEN FLOOR
LIGHTING
(BLACK)

PACKAGE
1/12

327,5mm

Ø152

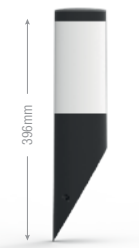

PRODUCT COD
016 038 010122

DESCRIPTION
GARDEN WALL
LIGHTING
(BLACK)

PACKAGE
1/20

396mm



PRODUCT COD
016 038 010124

DESCRIPTION
GARDEN LIGHT
WALL LAMP
(BLACK)

PACKAGE
1/16

251,5mm

173,5mm



PRODUCT COD
016 038 010121

DESCRIPTION
GARDEN LONG
FLOOR LIGHTING
(GREY)

PACKAGE
1/8

542,3mm

Ø151,8



PRODUCT COD
016 038 010119

DESCRIPTION
GARDEN FLOOR
LIGHTING
(GREY)

PACKAGE
1/12

327,5mm

Ø152



PRODUCT COD
016 038 010123

DESCRIPTION
GARDEN WALL
LIGHTING
(GREY)

PACKAGE
1/20

396mm



PRODUCT COD
016 038 010125

DESCRIPTION
GARDEN LIGHT
WALL LAMP
(GREY)

PACKAGE
1/16

251,5mm

173,5mm

New

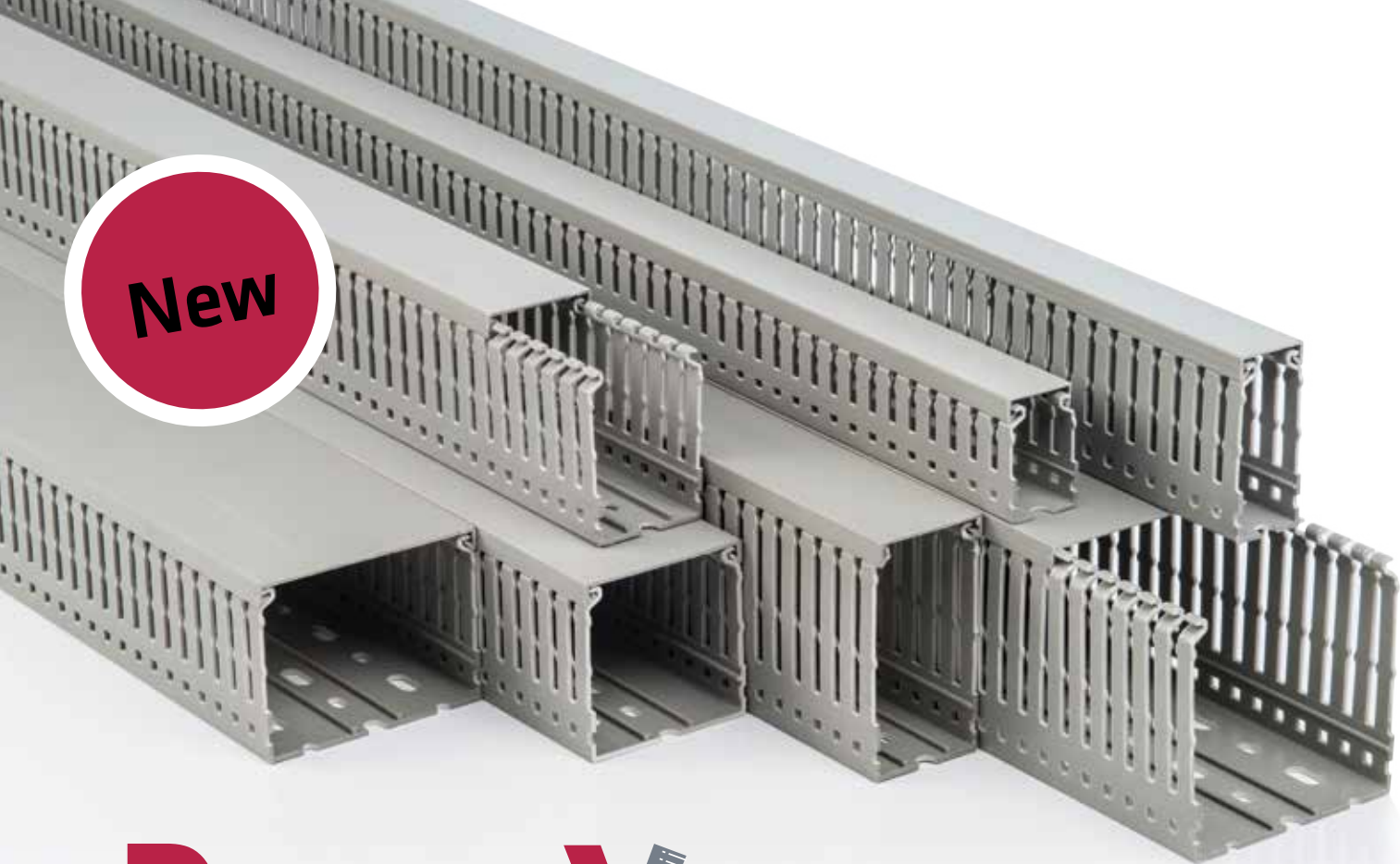

Promex

SLOTTED TRUNKING



Side ribs can be broken easily from the upper part of trunking without using any tool.



Especially designed ribs allow you to tight cables into trunking. You can make faster and stronger cabling through specially designed cable tie fixing slots.

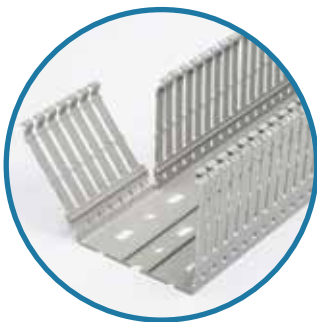

Side wall can be removed easily from the bottom level scorline.



Strongly designed trunking cover allows you to assemble and disassemble it in any poistion of fixing. Cover will not come out even in case of mass cabling.



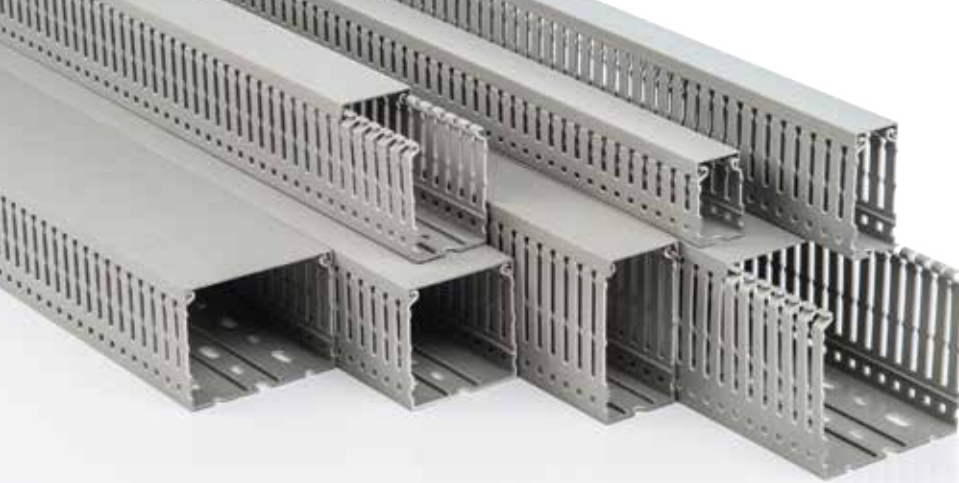

Cod	Product Description	Slot Spacing (mm)	Package
-----	---------------------	-------------------	---------

PROMEX PERFORATED CABLE TRUNKING HALOGEN FREE

CE



001 065 025030 20 17	25X30 PROMEX PERFORATED CABLE TRUNKING H.F.	4/6/4 mm	2m. 120
001 065 025040 20 17	25X40 PROMEX PERFORATED CABLE TRUNKING H.F.	4/6/4 mm	2m. 128
001 065 025060 20 17	25X60 PROMEX PERFORATED CABLE TRUNKING H.F.	4/6/4 mm	2m. 96
001 065 025080 20 17	25X80 PROMEX PERFORATED CABLE TRUNKING H.F.	4/6/4 mm	2m. 64
001 065 040040 20 17	40X40 PROMEX PERFORATED CABLE TRUNKING H.F.	4/6/4 mm	2m. 70
001 065 040060 20 17	40X60 PROMEX PERFORATED CABLE TRUNKING H.F.	4/6/4 mm	2m. 60
001 065 040080 20 17	40X80 PROMEX PERFORATED CABLE TRUNKING H.F.	4/6/4 mm	2m. 40
001 065 040100 20 17	40X100 PROMEX PERFORATED CABLE TRUNKING H.F.	5/8/5 mm	2m. 40
001 065 060040 20 17	60X40 PROMEX PERFORATED CABLE TRUNKING H.F.	4/6/4 mm	2m. 50
001 065 060060 20 17	60X60 PROMEX PERFORATED CABLE TRUNKING H.F.	4/6/4 mm	2m. 48
001 065 060080 20 17	60X80 PROMEX PERFORATED CABLE TRUNKING H.F.	4/6/4 mm	2m. 32
001 065 060100 20 17	60X100 PROMEX PERFORATED CABLE TRUNKING H.F.	5/8/5 mm	2m. 32
001 065 080060 20 17	80X60 PROMEX PERFORATED CABLE TRUNKING H.F.	4/6/4 mm	2m. 25
001 065 080080 20 17	80X80 PROMEX PERFORATED CABLE TRUNKING H.F.	4/6/4 mm	2m. 24
001 065 080100 20 17	80X100 PROMEX PERFORATED CABLE TRUNKING H.F.	5/8/5 mm	2m. 24
001 065 100060 20 17	100X60 PROMEX PERFORATED CABLE TRUNKING H.F.	4/6/4 mm	2m. 20
001 065 100080 20 17	100X80 PROMEX PERFORATED CABLE TRUNKING H.F.	4/6/4 mm	2m. 20
001 065 100100 20 17	100X100 PROMEX PERFORATED CABLE TRUNKING H.F.	5/8/5 mm	2m. 16
001 065 120060 20 17	120X60 PROMEX PERFORATED CABLE TRUNKING H.F.	4/6/4 mm	2m. 20
001 065 120080 20 17	120X80 PROMEX PERFORATED CABLE TRUNKING H.F.	4/6/4 mm	2m. 16

PROMEX PERFORATED CABLE TRUNKING

CE

001 105 025030 20 17	25X30 PROMEX PERFORATED CABLE TRUNKING	4/6/4 mm	2m. 120
001 105 025040 20 17	25X40 PROMEX PERFORATED CABLE TRUNKING	4/6/4 mm	2m. 128
001 105 025060 20 17	25X60 PROMEX PERFORATED CABLE TRUNKING	4/6/4 mm	2m. 96
001 105 025080 20 17	25X80 PROMEX PERFORATED CABLE TRUNKING	4/6/4 mm	2m. 64
001 105 040040 20 17	40X40 PROMEX PERFORATED CABLE TRUNKING	4/6/4 mm	2m. 70
001 105 040060 20 17	40X60 PROMEX PERFORATED CABLE TRUNKING	4/6/4 mm	2m. 60
001 105 040080 20 17	40X80 PROMEX PERFORATED CABLE TRUNKING	4/6/4 mm	2m. 40
001 105 040100 20 17	40X100 PROMEX PERFORATED CABLE TRUNKING	5/8/5 mm	2m. 40
001 105 060040 20 17	60X40 PROMEX PERFORATED CABLE TRUNKING	4/6/4 mm	2m. 50
001 105 060060 20 17	60X60 PROMEX PERFORATED CABLE TRUNKING	4/6/4 mm	2m. 48
001 105 060080 20 17	60X80 PROMEX PERFORATED CABLE TRUNKING	4/6/4 mm	2m. 32
001 105 060100 20 17	60X100 PROMEX PERFORATED CABLE TRUNKING	5/8/5 mm	2m. 32
001 105 080060 20 17	80X60 PROMEX PERFORATED CABLE TRUNKING	4/6/4 mm	2m. 25
001 105 080080 20 17	80X80 PROMEX PERFORATED CABLE TRUNKING	4/6/4 mm	2m. 24
001 105 080100 20 17	80X100 PROMEX PERFORATED CABLE TRUNKING	5/8/5 mm	2m. 24
001 105 100060 20 17	100X60 PROMEX PERFORATED CABLE TRUNKING	4/6/4 mm	2m. 20
001 105 100080 20 17	100X80 PROMEX PERFORATED CABLE TRUNKING	4/6/4 mm	2m. 20
001 105 100100 20 17	100X100 PROMEX PERFORATED CABLE TRUNKING	5/8/5 mm	2m. 16
001 105 120060 20 17	120X60 PROMEX PERFORATED CABLE TRUNKING	4/6/4 mm	2m. 20
001 105 120080 20 17	120X80 PROMEX PERFORATED CABLE TRUNKING	4/6/4 mm	2m. 16

PROMEX PERFORATED CABLE TRUNKING COVER

CE

001 016 100025 20 17	25" PROMEX COVER		50
001 016 100040 20 17	40" PROMEX COVER		50
001 016 100060 20 17	60" PROMEX COVER		50
001 016 100080 20 17	80" PROMEX COVER		50
001 016 100100 20 17	100" PROMEX COVER		50
001 016 100120 20 17	120" PROMEX COVER		50

XX : 10 1mt. for perforated cable duct.
XX : 20 2mt. for perforated cable duct.

Code	Product Description	Number of Box	Quantity of Pack
SLOTTED CABLE TURNKING (GREY)			
001 005 025025 XX 17	25X25 CABLE TRUNKING(SLOTTED)(GRAY)(2M)	1mt. 64	2mt. 120
001 005 025040 XX 17	25X40 CABLE TRUNKING(SLOTTED)(GRAY)(2M)	1mt. 40	2mt. 80
001 005 025060 XX 17	25X60 CABLE TRUNKING(SLOTTED)(GRAY)(2M)	1mt. 36	2mt. 80
001 005 040040 XX 17	40X40 CABLE TRUNKING(SLOTTED)(GRAY)(2M)	1mt. 25	2mt. 50
001 005 040060 XX 17	40X60 CABLE TRUNKING(SLOTTED)(GRAY)(2M)	1mt. 24	2mt. 48
001 005 060040 XX 17	60X40 CABLE TRUNKING(SLOTTED)(GRAY)(2M)	1mt. 24	2mt. 48
001 005 060060 XX 17	60X60 CABLE TRUNKING(SLOTTED)(GRAY)(2M)	1mt. 16	2mt. 32
001 005 060080 XX 17	60X80 CABLE TRUNKING(SLOTTED)(GRAY)(2M)	1mt. 12	2mt. 24
001 005 060100 XX 17	60X100 CABLE TRUNKING(SLOTTED)(GRAY)(2M)	1mt. 8	2mt. 16
001 005 040080 XX 17	40X80 CABLE TRUNKING(SLOTTED)(GRAY)(2M)	1mt. 18	2mt. 36
001 005 080060 XX 17	80X60 CABLE TRUNKING(SLOTTED)(GRAY)(2M)	1mt. 12	2mt. 24
001 005 100060 XX 17	100X60 CABLE TRUNKING(SLOTTED)(GRAY)(2M)	1mt. 8	2mt. 16
001 005 100100 XX 17	100X100 CABLE TRUNK.(SLOTTED)(GRAY)(2M)	1mt. 4	2mt. 8

SLOTTED CABLE TURNKING (BLUE)			
001 005 025025 XX 13	25X25 CABLE TRUNKING(SLOTTED)(BLUE)(2M)	1mt. 64	2mt. 120
001 005 025040 XX 13	25X40 CABLE TRUNKING(SLOTTED)(BLUE)(2M)	1mt. 40	2mt. 80
001 005 025060 XX 13	25X60 CABLE TRUNKING(SLOTTED)(BLUE)(2M)	1mt. 36	2mt. 80
001 005 040040 XX 13	40X40 CABLE TRUNKING(SLOTTED)(BLUE)(2M)	1mt. 25	2mt. 50
001 005 040060 XX 13	40X60 CABLE TRUNKING(SLOTTED)(BLUE)(2M)	1mt. 24	2mt. 48
001 005 060040 XX 13	60X40 CABLE TRUNKING(SLOTTED)(BLUE)(2M)	1mt. 24	2mt. 48
001 005 060060 XX 13	60X60 CABLE TRUNKING(SLOTTED)(BLUE)(2M)	1mt. 16	2mt. 32
001 005 060080 XX 13	60X80 CABLE TRUNKING(SLOTTED)(BLUE)(2M)	1mt. 12	2mt. 24
001 005 060100 XX 13	60X100 CABLE TRUNK.(SLOTTED)(BLUE)(2M)	1mt. 8	2mt. 16
001 005 040080 XX 13	40X80 CABLE TRUNKING(SLOTTED)(BLUE)(1M)	1mt. 18	2mt. 36
001 005 080060 XX 13	80X60 CABLE TRUNKING(SLOTTED)(BLUE)(2M)	1mt. 12	2mt. 24
001 005 100060 XX 13	100X60 CABLE TRUNKING(SLOTTED)(BLUE)(2M)	1mt. 8	2mt. 16
001 005 100100 XX 13	100X100 CABLE TRUNK.(SLOTTED)(BLUE)(2M)	1mt. 4	2mt. 8

SLOTTED CABLE TURNKING ADHESIVE (BLUE)			
001 008 025025 XX 13	25X25 CABLE TRUNK.(SLOTTED)(BLUE)(ADH.)	1mt. 64	2mt. 120
001 008 025040 XX 13	25X40 CABLE TRUNK.(SLOTTED)(BLUE)(ADH.)	1mt. 40	2mt. 80
001 008 025060 XX 13	25X60 CABLE TRUNK.(SLOTTED)(BLUE)(ADH.)	1mt. 36	2mt. 80
001 008 040040 XX 13	40X40 CABLE TRUNK.(SLOTTED)(BLUE)(ADH.)	1mt. 25	2mt. 50
001 008 040060 XX 13	40X60 CABLE TRUNK.(SLOTTED)(BLUE)(ADH.)	1mt. 24	2mt. 48
001 008 060040 XX 13	60X40 CABLE TRUNK.(SLOTTED)(BLUE)(ADH.)	1mt. 24	2mt. 48
001 008 060060 XX 13	60X60 CABLE TRUNK.(SLOTTED)(BLUE)(ADH.)	1mt. 16	2mt. 32
001 008 060080 XX 13	60X80 CABLE TRUNK.(SLOTTED)(2M)(BLUE)(ADH.)	1mt. 12	2mt. 24
001 008 060100 XX 13	60X100 CABLE TRUNK.(SLOTTED)(2M)(BLUE)(ADH.)	1mt. 8	2mt. 16
001 008 040080 XX 13	40X80 CABLE TRUNK.(SLOTTED)(BLUE)(ADH.)	1mt. 18	2mt. 36
001 008 080060 XX 13	80X60 CABLE TRUNK.(SLOTTED)(BLUE)(ADH.)	1mt. 12	2mt. 24
001 008 100060 XX 13	100X60 CABLE TRUNK.(SLOTTED)(BLUE)(ADH.)	1mt. 8	2mt. 16
001 008 100100 XX 13	100X100 CABLE TRUNK.(SLOTTED)(BLUE)(ADH.)	1mt. 4	2mt. 8

SLOTTED CABLE TURNKING ADHESIVE (GREY)			
001 008 025025 XX 17	25X25 CABLE TRUNK.(SLOTTED)(GRAY)(ADH.)	1mt. 64	2mt. 120
001 008 025040 XX 17	25X40 CABLE TRUNK.(SLOTTED)(GRAY)(ADH.)	1mt. 40	2mt. 80
001 008 025060 XX 17	25X60 CABLE TRUNK.(SLOTTED)(GRAY)(ADH.)	1mt. 36	2mt. 80
001 008 040040 XX 17	40X40 CABLE TRUNK.(SLOTTED)(GRAY)(ADH.)	1mt. 25	2mt. 50
001 008 040060 XX 17	40X60 CABLE TRUNK.(SLOTTED)(GRAY)(ADH.)	1mt. 24	2mt. 48
001 008 060040 XX 17	60X40 CABLE TRUNK.(SLOTTED)(GRAY)(ADH.)	1mt. 24	2mt. 48
001 008 060060 XX 17	60X60 CABLE TRUNK.(SLOTTED)(GRAY)(ADH.)	1mt. 16	2mt. 32
001 008 060080 XX 17	60X80 CABLE TRUNK.(SLOTTED)(2M)(GRAY)(ADH.)	1mt. 12	2mt. 24
001 008 060100 XX 17	6X100 CABLE TRUNK.(SLOTTED)(GRAY)(ADH.)	1mt. 8	2mt. 16
001 008 040080 XX 17	40X80 CABLE TRUNK.(SLOTTED)(GRAY)(ADH.)	1mt. 18	2mt. 36
001 008 080060 XX 17	80X60 CABLE TRUNK.(SLOTTED)(GRAY)(ADH.)	1mt. 12	2mt. 24
001 008 100060 XX 17	100X60 CABLE TRUNK.(SLOTTED)(GRAY)(ADH.)	1mt. 8	2mt. 16
001 008 100100 XX 17	100X100 CABLE TRUNK.(SLOTTED)(GRAY)(ADH.)	1mt. 4	2mt. 8

CABLE HOLDER APPARATUS			
001 050 010001 00 00	25X40 CABLE HOLDER APPARATUS		
001 050 010002 00 00	40X40 CABLE HOLDER APPARATUS		40 pcs.
001 050 010003 00 00	60X40 CABLE HOLDER APPARATUS		50 pcs.

CABLE HOLDER SIDE APPARATUS			
001 050 020001 00 00	40X40/60 CABLE HOLDER SIDE APPARATUS		100
001 050 020002 00 00	60X40/60 CABLE HOLDER SIDE APPARATUS		100
001 050 020003 00 00	80X60 CABLE HOLDER SIDE APPARATUS		100
001 050 020004 00 00	100X60 CABLE HOLDER SIDE APPARATUS		100

CABLE TRUNKING SCISSORS			
999 999 777139	PDC110 CABLE TRUNKING SCISSORS 60MM		1 pcs.

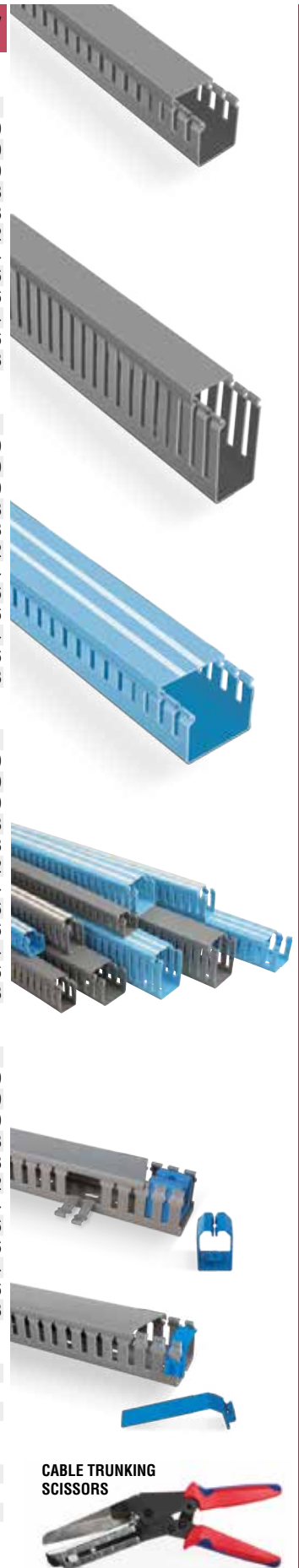

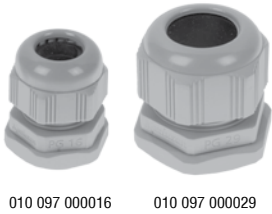

010 097 000016 010 097 000029

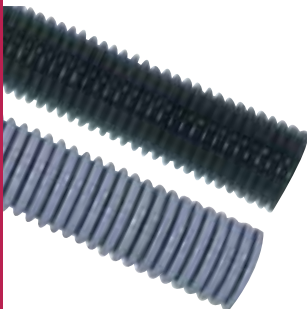

Code	Product Description	Number of Box	Quantity of Pack		
SUPER WATERPROOF PLASTIC CABLE GLAND					
CE					
000007 097 010	PG7- PLASTIC CABLE GLANDS	450 pcs.	4500		
000009 097 010	PG9- PLASTIC CABLE GLANDS	300 pcs.	3000		
000011 097 010	PG11- PLASTIC CABLE GLANDS	200 pcs.	2000		
000135 097 010	PG13,5- PLASTIC CABLE GLANDS	175 pcs.	1750		
000016 097 010	PG16- PLASTIC CABLE GLANDS	125 pcs.	1250		
000021 097 010	PG21- PLASTIC CABLE GLANDS	75 pcs.	750		
000029 097 010	PG29- PLASTIC CABLE GLANDS	40 pcs.	400		
000036 097 010	PG36- PLASTIC CABLE GLANDS	20 pcs.	200		
000042 097 010	PG42- PLASTIC CABLE GLANDS	15 pcs.	150		
000048 097 010	PG48- PLASTIC CABLE GLANDS	12 pcs.	120		
POLYAMIDE SPIRAL CABLE GLAND					
110007 097 057	PSR7- POLYAMID SPIRAL GLAND	50 pcs.			
110009 097 057	PSR9- POLYAMID SPIRAL GLAND	50 pcs.			
110011 097 057	PSR11- POLYAMID SPIRAL GLAND	50 pcs.			
110135 097 057	PSR13,5- POLYAMID SPIRAL GLAND	50 pcs.			
110016 097 057	PSR16- POLYAMID SPIRAL GLAND	25 pcs.			
110021 097 057	PSR21- POLYAMID SPIRAL GLAND	20 pcs.			
110029 097 057	PSR29- POLYAMID SPIRAL GLAND	10 pcs.			
110036 097 057	PSR36- POLYAMID SPIRAL GLAND	1 pcs.			
110048 097 057	PSR48- POLYAMID SPIRAL GLAND	1 pcs.			
POLYAMIDE SPIRAL CABLE GLAND (90 ANGLE BRACKET)					
120007 097 057	PSRD7- POLYAMID SPIRAL GLAND 90 BRACKET	1 pcs.			
120009 097 057	PSRD9- POLYAMID SPIRAL GLAND 90 BRACKET	1 pcs.			
120011 097 057	PSRD11- POLYAMID SPIRAL GLAND 90 BRACKET	1 pcs.			
120135 097 057	PSRD13,5- POLYAMID SPIRAL GLAND 90 BRACKET	1 pcs.			
120016 097 057	PSRD16- POLYAMID SPIRAL GLAND 90 BRACKET	1 pcs.			
120021 097 057	PSRD21- POLYAMID SPIRAL GLAND 90 BRACKET	1 pcs.			
120029 097 057	PSRD29- POLYAMID SPIRAL GLAND 90 BRACKET	1 pcs.			
120036 097 057	PSRD36- POLYAMID SPIRAL GLAND 90 BRACKET	1 pcs.			
POLYAMIDE SPIRAL CROCKET					
160007 097 057	PG7- POLYAMIDE SPIRAL CROCHET (GRAY-BLACK)	50 pcs.			
160009 097 057	PG9- POLYAMIDE SPIRAL CROCHET (GRAY-BLACK)	50 pcs.			
160011 097 057	PG11- POLYAMIDE SPIRAL CROCHET (GRAY-BLACK)	50 pcs.			
160135 097 057	PG13,5- POLYAMIDE SPIRAL CROCHET (GRAY-BLACK)	50 pcs.			
160016 097 057	PG16- POLYAMIDE SPIRAL CROCHET (GRAY-BLACK)	50 pcs.			
160021 097 057	PG21- POLYAMIDE SPIRAL CROCHET (GRAY-BLACK)	25 pcs.			
160029 097 057	PG29- POLYAMIDE SPIRAL CROCHET (GRAY-BLACK)	25 pcs.			
160036 097 057	PG36- POLYAMIDE SPIRAL CROCHET (GRAY-BLACK)	25 pcs.			
160048 097 057	PG48- POLYAMIDE SPIRAL CROCHET (GRAY-BLACK)	10 pcs.			
PP POLYPROPYLENE SPIRALS					
00 160007 020 001 XX	Ø7 POLYPROPYLENE SPIRAL PIPE	PSR7	7 10,1	100 mt.	1000
00 160009 020 001 XX	Ø8,5 POLYPROPYLENE SPIRAL PIPE		8,4 12,05	100 mt.	1000
00 160010 020 001 XX	Ø10 POLYPROPYLENE SPIRAL PIPE	PSR9	10,2 13,1	100 mt.	1000
00 160012 020 001 XX	Ø12 POLYPROPYLENE SPIRAL PIPE	PSR11	12,3 15,9	50 mt.	500
00 160014 020 001 XX	Ø14 POLYPROPYLENE SPIRAL PIPE	PSR13,5	14,1 18,35	50 mt.	250
00 160017 020 001 XX	Ø17 POLYPROPYLENE SPIRAL PIPE	PSR16	17 21,45	50 mt.	250
00 160019 020 001 XX	Ø19 POLYPROPYLENE SPIRAL PIPE		19 24,25	50 mt.	250
00 160023 020 001 XX	Ø23 POLYPROPYLENE SPIRAL PIPE	PSR21	23,25 28,5	50 mt.	250
00 160026 020 001 XX	Ø26 POLYPROPYLENE SPIRAL PIPE		26,2 31,3	25 mt.	125
00 160029 020 001 XX	Ø29 POLYPROPYLENE SPIRAL PIPE	PSR29	29,1 34,3	25 mt.	125
00 160036 020 001 XX	Ø36 POLYPROPYLENE SPIRAL PIPE	PSR36	35,8 42,2	25 mt.	125
00 160048 020 001 XX	Ø48 POLYPROPYLENE SPIRAL PIPE	PSR48	48,5 54,5	25 mt.	125
PA6 POLYAMIDE SPIRALS (FLAME RETARDANT)					
00 170007 020 001 XX	Ø7 POLYAMIDE SPIRAL PIPE (NONFLAME)	PSR7	7 10,1	100 mt.	1000
00 170009 020 001 XX	Ø8,5 POLYAMIDE SPIRAL PIPE (NONFLAME)		8,4 12,05	100 mt.	1000
00 170010 020 001 XX	Ø10 POLYAMIDE SPIRAL PIPE (NONFLAME)	PSR9	10,2 13,1	100 mt.	1000
00 170012 020 001 XX	Ø12 POLYAMIDE SPIRAL PIPE (NONFLAME)	PSR11	12,3 15,9	50 mt.	500
00 170014 020 001 XX	Ø14 POLYAMIDE SPIRAL PIPE (NONFLAME)	PSR13,5	14,1 18,35	50 mt.	250
00 170017 020 001 XX	Ø17 POLYAMIDE SPIRAL PIPE (NONFLAME)	PSR16	17 21,45	50 mt.	250
00 170019 020 001 XX	Ø19 POLYAMIDE SPIRAL PIPE (NONFLAME)		19 24,25	50 mt.	250
00 170023 020 001 XX	Ø23 POLYAMIDE SPIRAL PIPE (NONFLAME)	PSR21	23,25 28,5	50 mt.	250
00 170026 020 001 XX	Ø26 POLYAMIDE SPIRAL PIPE (NONFLAME)		26,2 31,3	25 mt.	125
00 170029 020 001 XX	Ø29 POLYAMIDE SPIRAL PIPE (NONFLAME)	PSR29	29,1 34,3	25 mt.	125
00 170036 020 001 XX	Ø36 POLYAMIDE SPIRAL PIPE (NONFLAME)	PSR36	36,2 42,2	25 mt.	125
00 170048 020 001 XX	Ø48 POLYAMIDE SPIRAL PIPE (NONFLAME)	PSR48	48,5 54,5	25 mt.	125
POLYAMIDE SLOTTED SPIRAL PIPE (NON-FLAME-PROPAGATING)					
00 470007 020 001 XX	Ø7 POLYAMIDE SLOTTED SPIRAL PIPE (NON-FLAME-PROPAGATING)				
00 470009 020 001 XX	Ø8,5 POLYAMIDE SLOTTED SPIRAL PIPE (NON-FLAME-PROPAGATING)				
00 470010 020 001 XX	Ø10 POLYAMIDE SLOTTED SPIRAL PIPE (NON-FLAME-PROPAGATING)				
00 470012 020 001 XX	Ø12 POLYAMIDE SLOTTED SPIRAL PIPE (NON-FLAME-PROPAGATING)				
00 470014 020 001 XX	Ø14 POLYAMIDE SLOTTED SPIRAL PIPE (NON-FLAME-PROPAGATING)				
00 470017 020 001 XX	Ø17 POLYAMIDE SLOTTED SPIRAL PIPE (NON-FLAME-PROPAGATING)				
00 470019 020 001 XX	Ø19 POLYAMIDE SLOTTED SPIRAL PIPE (NON-FLAME-PROPAGATING)				
00 470023 020 001 XX	Ø23 POLYAMIDE SLOTTED SPIRAL PIPE (NON-FLAME-PROPAGATING)				
00 470026 020 001 XX	Ø26 POLYAMIDE SLOTTED SPIRAL PIPE (NON-FLAME-PROPAGATING)				
00 470029 020 001 XX	Ø29 POLYAMIDE SLOTTED SPIRAL PIPE (NON-FLAME-PROPAGATING)				
00 470036 020 001 XX	Ø36 POLYAMIDE SLOTTED SPIRAL PIPE (NON-FLAME-PROPAGATING)				
00 470048 020 001 XX	Ø48 POLYAMIDE SLOTTED SPIRAL PIPE (NON-FLAME-PROPAGATING)				

Code	Product Description	Number of Box	Quantity of Pack
CABLE FIX CABLE TIES			
062 129 010101	EA.01.101 BEAD CLAMP 2X105	1000 pcs.	25000
062 129 010102	EA.02.102 BEAD CLAMP 3.5X165	500 pcs.	8000
062 129 500000	EA.04.104 BEAD CLAMP 3.5X235	100 pcs.	5000
062 129 025100	EB.02.202 CABLE TIE 2.5X100	1000 pcs.	80000
062 129 025140	EB.12.212 CABLE TIE 2.5X140	100 pcs.	50000
062 129 025200	EB.13.213 CABLE TIE 2.5X200	100 pcs.	35000
062 129 036150	EB.03.203 CABLE TIE 3.6X150	100 pcs.	30000
062 129 036205	EB.04.204 CABLE TIE 3.6X205	100 pcs.	25000
062 129 036250	EB.09.209 CABLE TIE 3.6X250	100 pcs.	22500
062 129 036300	EB.10.210 CABLE TIE 3.6X300	100 pcs.	17500
062 129 036370	EB.11.211 CABLE TIE 3.6X370	100 pcs.	16000
062 129 048200	EB.14.214 CABLE TIE 4,8X200	100 pcs.	17000
062 129 048250	EB.06.206 CABLE TIE 4,8X250	100 pcs.	15000
062 129 048300	EB.05.205 CABLE TIE 4,8X300	100 pcs.	15000
062 129 500001	EB.25.225 CABLE TIE 4,8X350	100 pcs.	12000
062 129 048400	EB.16.216 CABLE TIE 4,8X400	100 pcs.	10000
062 129 500002	EB.26.226 CABLE TIE 4,8X450	100 pcs.	10000
062 129 008250	EB.07.207 CABLE TIE 8X250	100 pcs.	8000
062 129 008300	EB.18.218 CABLE TIE 8X300	100 pcs.	6000
062 129 008380	EB.19.219 CABLE TIE 8X380	100 pcs.	6000
062 129 008450	EB.21.221 CABLE TIE 8X450	100 pcs.	5000
062 129 008550	EB.15.215 CABLE TIE 8X550	100 pcs.	4000
062 129 008750	EB.24.224 CABLE TIE 8X750	100 pcs.	2000
062 129 009940	EB.22.222 CABLE TIE 9X940	100 pcs.	1500
062 129 009762	EB.17.217 CABLE TIE 9X762	100 pcs.	1500

CROCHET AND CLIPSES

062 129 132020	EK.01.1001 ADHESIVE CROCHETS 20X20	100 pcs.	
062 129 132828	EK.03.1003 ADHESIVE CROCHETS 28X28	100 pcs.	
062 129 131316	EK.16.1016 ADHESIVE CLIP 13X16	100 pcs.	
062 129 132525	EK.05.1005 ADHESIVE CLIP 25X25	100 pcs.	
062 129 191325	EK.19.1019 ADHESIVE CLIPS 13X25	100 pcs.	
062 129 142525	EK.07.1007 ADHESIVE CLIP 25X25	100 pcs.	
062 129 151017	EK.06.1006 CROCHET W.SCREW 10X17	250 pcs.	
062 129 151723	EK.02.1002 CROCHET W.SCREW 17X23	250 pcs.	
062 129 151530	EK.13.1013 CROCHET W.SCREW 15X30	100 pcs.	
062 129 161004	EK.04.1004 CROCHET WITH SOCKET 6 HOLES	500 pcs.	
062 129 171009	EK.09.1009 WALL CROCHET 6 HOLES	250 pcs.	
033 129 100008	CANAL FASTENER	250 pcs.	
062 129 171011	EK.11.1011 TRUNKING CROCHET 6 HOLES	250 pcs.	
062 129 500003	EK.63.1063 CABLE CLIP 6,4 (1/4»)	100 pcs.	
062 129 500004	EK.64.1064 CABLE CLIP 7,9 (5/16»)	100 pcs.	
062 129 500005	EK.65.1065 CABLE CLIP 10,9 (3/8»)	100 pcs.	

PEMSAN TWIST TYPE CLAMPS

060 120 005105	EA.05.105 TWIST CLAMP	500 pcs.	
060 120 007107	EA.07.107 TWIST CLAMP	500 pcs.	
060 120 010110	EA.10.110 TWIST CLAMP	500 pcs.	
060 120 014114	EA.14.114 TWIST CLAMP	500 pcs.	
060 120 017117	EA.17.117 TWIST CLAMP	500 pcs.	

LABELS

062 129 111035	CABLE TIE LABEL 10X35	100 pcs.	
062 129 112045	CABLE TIE LABEL 20X45	100 pcs.	
062 129 121530	ET.02.902 LABEL STICKER 17X30	100 pcs.	
062 129 121750	ADHESIVE PANNEL LABEL 17X50	50 pcs.	
062 129 122075	ADHESIVE PANNEL LABEL 17X75	25 pcs.	

HELIX PANEL SPIRAL S M

		İç Çap	Dış Çap		
001 020 500001 05 00	NO.1 CABLE WRAPPING SPIRAL(50CM)	5	6	100 pcs.	4000
001 020 500002 05 00	NO.2 CABLE WRAPPING SPIRAL(50CM)	7	8	100 pcs.	3000
001 020 500003 05 00	NO.3 CABLE WRAPPING SPIRAL(50CM)	10	11	100 pcs.	2000
001 020 500004 05 00	NO.4 CABLE WRAPPING SPIRAL(50CM)	13	14	50 pcs.	800
001 020 500005 05 00	NO.5 CABLE WRAPPING SPIRAL(50CM)	16	17	50 pcs.	800

HELIX PANEL SPIRAL(ROLL)

001 020 600001 00 00	NO.1 CABLE WRAPPING SPIRAL ROLL	5	6	100 mt.	500
001 020 600002 00 00	NO.2 CABLE WRAPPING SPIRAL ROLL	7	8	100 mt.	500
001 020 600003 00 00	NO.3 CABLE WRAPPING SPIRAL ROLL	10	11	100 mt.	500
001 020 600004 00 00	NO.4 CABLE WRAPPING SPIRAL ROLL	13	14	50 mt.	250
001 020 600005 00 00	NO.5 CABLE WRAPPING SPIRAL ROLL	16	17	50 mt.	250

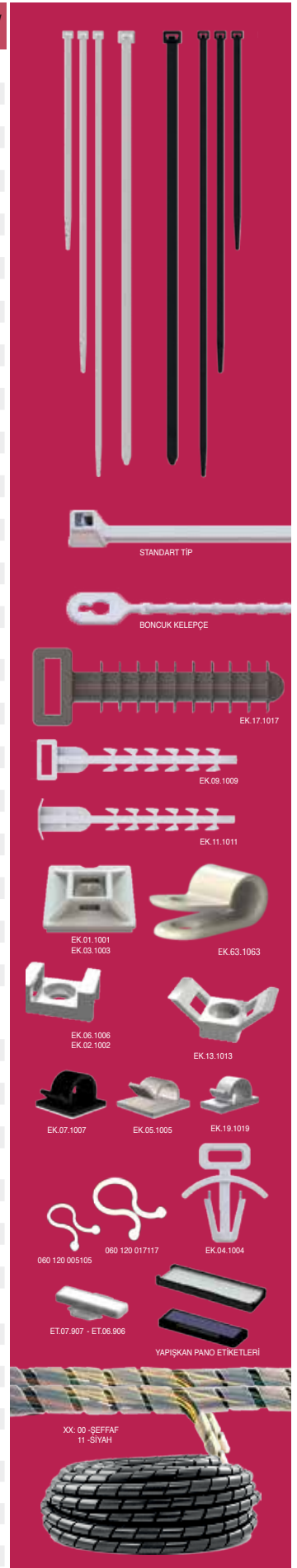

Poliüretan
Sızdırmazlık

CE

NEW

PLASTIC PANNEL OPAK COVER

Code	Dimensions	Product Type	Weight(Kg)	Piece
001 046 203013 00 17	20X30X13	PLASTIC PANEL OPAK COVER	1,70	1
001 046 253515 00 17	25X35X15	PLASTIC PANEL OPAK COVER	2,20	1
001 046 304017 00 17	30X40X17	PLASTIC PANEL OPAK COVER	3,00	1
001 046 304022 00 17	30X40X22	PLASTIC PANEL OPAK COVER	3,40	1
001 046 355019 00 17	35X50X19	PLASTIC PANEL OPAK COVER	4,30	1
001 046 405018 00 17	40X50X18	PLASTIC PANEL OPAK COVER	4,30	1
001 046 405024 00 17	40X50X24	PLASTIC PANEL OPAK COVER	5,60	1
001 046 406020 00 17	40X60X20	PLASTIC PANEL OPAK COVER	6,00	1
001 046 507025 00 17	50X70X25	PLASTIC PANEL OPAK COVER	10,10	1
001 046 608026 00 17	60X80X26	PLASTIC PANEL OPAK COVER	13,50	1

PLASTIC PANNEL TRANSPARENT COVER

Code	Dimensions	Product Type	Weight(Kg)	Piece
001 046 203013 00 44	20X30X13	PLASTIC PANEL TRANSPARENT COVER	1,70	1
001 046 253515 00 44	25X35X15	PLASTIC PANEL TRANSPARENT COVER	2,20	1
001 046 304017 00 44	30X40X17	PLASTIC PANEL TRANSPARENT COVER	3,00	1
001 046 304022 00 44	30X40X22	PLASTIC PANEL TRANSPARENT COVER	3,40	1
001 046 355019 00 44	35X50X19	PLASTIC PANEL TRANSPARENT COVER	4,30	1
001 046 405018 00 44	40X50X18	PLASTIC PANEL TRANSPARENT COVER	4,30	1
001 046 405024 00 44	40X50X24	PLASTIC PANEL TRANSPARENT COVER	5,60	1
001 046 406020 00 44	40X60X20	PLASTIC PANEL TRANSPARENT COVER	6,00	1
001 046 507025 00 44	50X70X25	PLASTIC PANEL TRANSPARENT COVER	10,10	1
001 046 608026 00 44	60X80X26	PLASTIC PANEL TRANSPARENT COVER	13,50	1

CE

NEW

OPAK COVERED ABS FUSE PANELS

Code	Dimensions	Product Type	Weight(Kg)	Piece
001 046 253515 01 17	25X35X15	18 FUSE (9X2)	2,50	1
001 046 304017 01 17	30X40X17	24 FUSE (12X2)	3,40	1
001 046 355019 01 17	35X50X19	45 FUSE (15X3)	4,50	1
001 046 406020 01 17	40X60X20	60 FUSE (15X4)	6,00	1

CE



TRANSPARENT COVERED ABS FUSE PANELS

Code	Dimensions	Product Type	Weight(Kg)	Piece
001 046 253515 01 44	25X35X15	18 FUSE (9X2)	2,50	1
001 046 304017 01 44	30X40X17	24 FUSE (12X2)	3,40	1
001 046 355019 01 44	35X50X19	45 FUSE (15X3)	4,50	1
001 046 406020 01 44	40X60X20	60 FUSE (15X4)	6,00	1

GALVANIZED BASE SHEETS



Code	Size	Product Thickness (mm)	Pcs.
000 702 203013 00 00	20X30X13	GALVANIZED BASE SHEETS 1mm	1
000 702 253515 00 00	25X35X15	GALVANIZED BASE SHEETS 1mm	1
000 702 304017 00 00	30X40X17	GALVANIZED BASE SHEETS 1mm	1
000 702 304022 00 00	30X40X22	GALVANIZED BASE SHEETS 1mm	1
000 702 355019 00 00	35X50X19	GALVANIZED BASE SHEETS 1mm	1
000 702 405018 00 00	40X50X17,5	GALVANIZED BASE SHEETS 1mm	1
000 702 405024 00 00	40X50X24	GALVANIZED BASE SHEETS 1mm	1
000 702 406020 00 00	40X60X20	GALVANIZED BASE SHEETS 1mm	1
000 702 507025 00 00	50X70X25	GALVANIZED BASE SHEETS 1mm	1

MODULAR KITS AND SEPERATORS



Code	Size	Product	Pcs.
000 700 253515 01 17	25X35X15	18 FUSE (9X2)	1
000 700 304017 01 17	30X40X17	24 FUSE (12X2)	1
000 700 355019 01 17	35X50X19	45 FUSE (15X3)	1
000 700 406020 01 17	40X60X20	60 FUSE (15X4)	1
000 700 253515 00 17	25X35X15	PLASTIC CURTAIN	1
000 700 304017 00 17	30X40X17	PLASTIC CURTAIN	1
000 700 355019 00 17	35X50X19	PLASTIC CURTAIN	1
000 700 406020 00 17	40X60X20	PLASTIC CURTAIN	1

PANEL ACCESSORIES



Code	Product	Pcs.
000 700 000720 00 00	LOCK CYLINDER KIT	1
000 700 000700 00 00	PANEL WALL MOUNTING APPARATUS (4-SET)	1
000 700 000711 00 17	PLASTIC TRIANGLE KEY	1
000 700 000712 00 17	PANEL SEPERATOR HOLDING SCREW	1
000 700 000721 00 00	PLASTIC LOCKABLE PANEL LOCK	1

CUTOFF AND NH00 RULES



Code	Product	Pcs.
025 110 000001	THREE-PHASE CIRCUIT BREAKER	1
025 110 000002	MONOPHASE CIRCUIT BREAKER	2
025 110 000003	POLYESTER ELECTRIC BOX	1
025 110 000004	NH00 FUSE BASE (TERMINALS)	6
025 110 000014	NH00 FUSE BASE (NUT)	6
025 110 000005	NH00 FUSE (40A.-160A.)	10
025 110 000025	NH POLYESTER UNDER GROUND FUSE BOX	1

RAIL TYPE PANEL SOCKET

New



CODE : 010 104 000157
DESCRIPTION : 1X16 RAIL TYPE PANEL SOCKET
PACKAGE : 10



CODE : 010 104 000158
DESCRIPTION : 1X16 RAIL TYPE PANEL SOCKET LED
PACKAGE : 10



CODE : 010 104 000159
DESCRIPTION : 1X16 RAIL TYPE PANEL SOCKET UPS
PACKAGE : 10

THERMOSTAT and HYGROSTAT



THERMOSTAT - NK



HEATING THERMOSTAT

Code : 048 095 000300
Setting Field : 0-60C
Contact Type : NK
Protection Class : IP20
Weight : 45gr
Package : 135

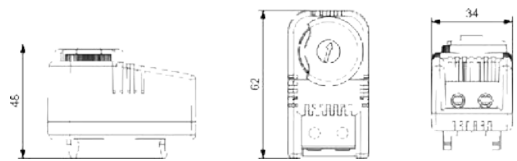

THERMOSTAT - NA



COOLING THERMOSTAT

Code : 048 095 000301
Setting Field : 0-60C
Contact Type : NA
Protection Class : IP20
Weight : 45gr
Package : 135

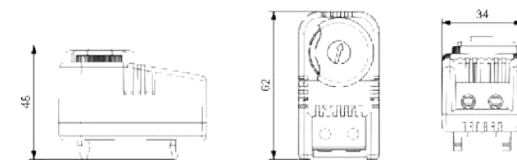

THERMOSTAT - NK+NA



DUAL THERMOSTAT

Code : 048 095 000302
Setting Field : 0-60C / 0-60C
Contact Type : NK+NA
Protection Class : IP20
Weight : 80gr
Package : 60

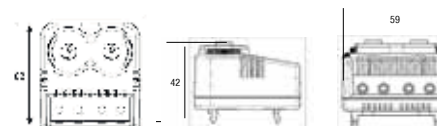

HYGROSTAT



MECHANICAL HYGROSTAT

Code : 048 095 000303
Setting Field : %10-90RH
Contact Type : 1CO
Protection Class : IP20
Weight : 180gr
Package : 30



DIGITAL THERMOSTAT AND HYGROSTAT



PDT 50-150 TEMPERATURE CONTROL DEVICE

Cod : 048 095 000304

Size	: 36x90x65mm Rail Mounting
Indicator	: 3 Hane 7 Segment
Sensor	: PTC
Measuring Scale	: -50...+150 C
Sensitivity	: ± C
Accuracy	: ±%1 (Full Scale)
Control Status	: ON-OFF
Output	: Relay, 250VAC, 2A, Resistive Load
Alarm Output	: Relay, 250VAC, 2A, Resistive Load
Heat Setting	: LoL...UPL C (Hst)
Alarm Setting	: AtP=Abs,-Ab; LoL... C (Ast) AtP=rEL, -rL; (HSt+rAL) ,(HSt-20) ... (Hst+20) C
Heat Hysteresis	: 1...20 C (Hhs)
Alarm Hysteresis	: 1...20 C (Hhs)
Offset	: -20...+20 C (OFS)
Heating / Cooling	:H-C; Ht (Heating), CL (cooling); optional
Supply Voltage	:100...240VAC, 50/60 Hz
Power consumption	: <6VA
Operating temperature	: -20C...55 C
Operating Altitude	: <2000m



NOTE: PTC Sensor is included in the device.

HT-310 TEMPERATURE AND MOISTURE CONTROLLER

Size	: 35x77mm
Indicator	: 3 Hane 7 Segment
Sensor	: Digital Temperature Humidity Sensor
Measuring Scale	: -19,9..+80,0C, 5 .. 95%RH
Sensitivity	: ±0,1 C,±1%RH
Accuracy	: ± %1 (C), ± %3 (%RH); Full Scale
Control Status	: ON-OFF
C Output	: Relay (NA + NK), 250VAC, 2A, Resistive load
%RH Output	: Relay, (NA), 250VAC, 2A, Resistive Load
Heating Cooling	: Ht (heating), CL (cooling); optional
Humidity Function	: lo (dehumidification), hi (dehumidification); optional
Supply Voltage	: 100...220VAC, 50 / 60Hz
Power consumption	: <6VA
Operating temperature	: 0...55 C
Operating Altitude	: <2000m

Cod : 048 095 000305



NOTE: Temperature and humidity sensor is included in the device.

ROOF FANS

NEW



Code	Fan Type	Power Supply	Power Consumption	Current Consumption	Noise Level	Air Flow Rate
048 095 000100	Ø172x163x51 AKSİYEL	220v AC 50/60hz	25/32W	0,11/0,15A	57dB	400m3/h
048 095 000101	Ø190x68 RADYAL	220v AC 50/60hz	58/75W	0,26/0,34A	62dB	560m3/h
048 095 000102	Ø220x71 RADYAL	220v AC 50/60hz	85/90W	0,38/0,44A	73dB	970m3/h

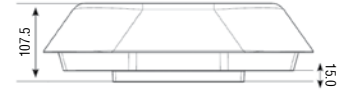
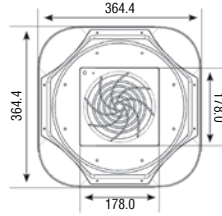

Fast and easy assembly without screws!



Code	Fan Type	Power Supply	Power Consumption	Current Consumption	Noise Level	Air Flow Rate
048 095 000200	Ø172x163x51 AKSİYEL	220v AC 50/60hz	25/32W	0,11/0,15A	57dB	400m3/h
048 095 000201	Ø190x68 RADYAL	220v AC 50/60hz	58/75W	0,26/0,34A	62dB	560m3/h
048 095 000202	Ø220x71 RADYAL	220v AC 50/60hz	85/90W	0,38/0,44A	73dB	970m3/h

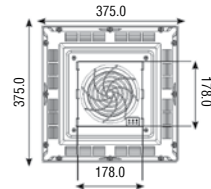



EASY INSTALLATION FILTER



Code	: 048 095 000400
Size (mm)	: 120x120x20.5
Diameter (mm)	: 92x92
Protection Class	: IP54
Quantity	: 200



Code	: 048 095 000401
Size (mm)	: 160x160x31
Diameter (mm)	: 125x125
Protection Class	: IP54
Quantity	: 100



Code	: 048 095 000402
Size (mm)	: 210x210x31
Diameter (mm)	: 177x177
Protection Class	: IP54
Quantity	: 100



Code	: 048 095 000403
Size (mm)	: 260x260x31
Diameter (mm)	: 223x223
Protection Class	: IP54
Quantity	: 50



Code	: 048 095 000404
Size (mm)	: 325x325x31
Diameter (mm)	: 291x291
Protection Class	: IP54
Quantity	: 50

PROJECT SIZE



Code	: 048 095 000902
Product	: Proje Cebi A4
Quantity	: 10
Price	: 1,93 \$

Code	: 048 095 000903
Product	: Proje Cebi A5
Quantity	: 10

FILTER FANS



Code	: 048 095 000500
Dimensions (mm)	: 120x120x58.5
Cutting Size (mm)	: 92x92
Fan Tipi	: 80x80x38 mm
Power Supply (VAC)	: 230V-50/60Hz
Power Consumption (W)	: 14 (13)
Speed (rpm)	: 2800
Filtreli (m³/h)	: 30
Firtresiz (m³/h)	: 41
Current Consumption (A)	: 0.08 / 0.07
Noise Level (db)	: 28 (31)



Code	: 048 095 000501
Dimensions (mm)	: 160x160x69
Cutting Size (mm)	: 125x125
Fan Tipi	: 120x120x38 mm
Power Supply (VAC)	: 230V-50/60Hz
Power Consumption (W)	: 26 (23)
Speed (rpm)	: 2700
Filtreli (m³/h)	: 100
Firtresiz (m³/h)	: 140
Current Consumption (A)	: 0.14 / 0.13
Noise Level (db)	: 42 (46)



Code	: 048 095 000502
Dimensions (mm)	: 120x120x58.5
Cutting Size (mm)	: 92x92
Fan Tipi	: 80x80x38 mm
Power Supply (VAC)	: 230V-50/60Hz
Power Consumption (W)	: 14 (13)
Speed (rpm)	: 2800
Filtreli (m³/h)	: 30
Firtresiz (m³/h)	: 41
Current Consumption (A)	: 0.08 / 0.07
Noise Level (db)	: 28 (31)



Code	: 048 095 000600
Dimensions (mm)	: 160x160x69
Cutting Size (mm)	: 125x125
Fan Tipi	: 120x120x38 mm
Power Supply (VAC)	: 230V-50/60Hz
Power Consumption (W)	: 26 (23)
Speed (rpm)	: 2700
Filtreli (m³/h)	: 100
Firtresiz (m³/h)	: 140
Current Consumption (A)	: 0.14 / 0.13
Noise Level (db)	: 42 (46)



Code	: 048 095 000601
Dimensions (mm)	: 210x210x98
Cutting Size (mm)	: 177x177
Fan Tipi	: 120x120x38 mm
Power Supply (VAC)	: 230V-50/60Hz
Power Consumption (W)	: 26 (23)
Speed (rpm)	: 2700
Filtreli (m³/h)	: 125
Firtresiz (m³/h)	: 175
Current Consumption (A)	: 0.14 / 0.13
Noise Level (db)	: 42 (46)

FILTER FANS



Code	: 048 095 000602
Dimensions (mm)	: 210x210x83
Cutting Size (mm)	: 177x177
Fan Tipi	: 172x163x51mm
Power Supply (VAC)	: 230V-50/60Hz
Power Consumption (W)	: 37 (35)
Speed (rpm)	: 2400
Filtreli (m³/h)	: 175
Firtresiz (m³/h)	: 245
Current Consumption (A)	: 0.23 / 0.22
Noise Level (db)	: 52 (53)



Code	: 048 095 000603
Dimensions (mm)	: 260x260x103
Cutting Size (mm)	: 223x223
Fan Tipi	: 120x120x38 mm
Power Supply (VAC)	: 230V-50/60Hz
Power Consumption (W)	: 26 (23)
Speed (rpm)	: 2700
Filtreli (m³/h)	: 115
Firtresiz (m³/h)	: 130
Current Consumption (A)	: 0.14 / 0.13
Noise Level (db)	: 42 (46)



Code	: 048 095 000604
Dimensions (mm)	: 260x260x116
Cutting Size (mm)	: 223x223
Fan Tipi	: 172x163x51mm
Power Supply (VAC)	: 230V-50/60Hz
Power Consumption (W)	: 37 (35)
Speed (rpm)	: 2400
Filtreli (m³/h)	: 240
Firtresiz (m³/h)	: 270
Current Consumption (A)	: 0.23 / 0.22
Noise Level (db)	: 52 (53)



Code	: 048 095 000605
Dimensions (mm)	: 260x260x111
Cutting Size (mm)	: 223x223
Fan Tipi	: 225x225x80 mm
Power Supply (VAC)	: 230V-50/60Hz
Power Consumption (W)	: 66 (75)
Speed (rpm)	: 2600
Filtreli (m³/h)	: 650
Firtresiz (m³/h)	: 900
Current Consumption (A)	: 0.35 / 0.38
Noise Level (db)	: 60 (63)



Code	: 048 095 000606
Dimensions (mm)	: 325x325x145
Cutting Size (mm)	: 291x291
Fan Tipi	: 225x225x80 mm
Power Supply (VAC)	: 230V-50/60Hz
Power Consumption (W)	: 66 (75)
Speed (rpm)	: 2600
Filtreli (m³/h)	: 700
Firtresiz (m³/h)	: 950
Current Consumption (A)	: 0.35 / 0.38
Noise Level (db)	: 60 (63)



Code	: 048 095 000607
Dimensions (mm)	: 325x325x111
Cutting Size (mm)	: 291x291
Fan Tipi	: 280x280x80 mm
Power Supply (VAC)	: 230V-50/60Hz
Power Consumption (W)	: 110 (140)
Speed (rpm)	: 2600
Filtreli (m³/h)	: 850
Firtresiz (m³/h)	: 1200
Current Consumption (A)	: 0.50 / 0.72
Noise Level (db)	: 65 (68)

HEATING



MPHT MINI HEATER



PHT PTC HEATER



SLIM HEATER

Code	Product	Besleme	Protection Class	Dimensions (AxBxC)(mm)	Connection
048 095 000700	MPHT 15 (15W PTC HEATERS)	100-250V AC-DC	IP20	60x50x27	CABLE
048 095 000701	MPHT 25 (25W PTC HEATERS)	100-250V AC-DC	IP20	70x50x27	CABLE
048 095 000702	PHT 030 (30W PTC HEATERS)	100-250V AC-DC	IP20	128x70x59	TERMINALS
048 095 000703	PHT 030 (30W PTC HEATERS)	100-250V AC-DC	IP20	138x70x59	TERMINALS
048 095 000704	PHT 075 (75W PTC HEATERS)	100-250V AC-DC	IP20	178x70x59	TERMINALS
048 095 000705	PHT 100 (100W PTC HEATERS)	100-250V AC-DC	IP20	188x70x59	TERMINALS
048 095 000706	PHT 150 (150W PTC HEATERS)	100-250V AC-DC	IP20	228x70x59	TERMINALS
048 095 000707	PSHT 030 (30W SLIM PTC HEATERS)	100-250V AC-DC	IP20	128x27x80	TERMINALS
048 095 000708	PSHT 050 (50W SLIM PTC HEATERS)	100-250V AC-DC	IP20	138x27x80	TERMINALS
048 095 000709	PSHT 075 (75W SLIM PTC HEATERS)	100-250V AC-DC	IP20	178x27x80	TERMINALS
048 095 000710	PSHT 100 (100W SLIM PTC HEATERS)	100-250V AC-DC	IP20	188x27x80	TERMINALS
048 095 000711	PSHT 150 (150W SLIM PTC HEATERS)	100-250V AC-DC	IP20	228x27x80	TERMINALS

HEATERS WITH FAN



PFHT FAN PTC HEATER



PFHT FAN HEATER



PFHT 400W PLASTIC FAN HEATER

Code	Product	Besleme	Protection Class	Dimensions (AxBxC)(mm)	Connection
048 095 000800	PFHT 100 (100W HEATERS WITH FAN)	230V AC 50/60 Hz	IP20	170x89x60	TERMINALS
048 095 000801	PFHT 150 (150W HEATERS WITH FAN)	230V AC 50/60 Hz	IP20	210x89x60	TERMINALS
048 095 000802	PFHT 250 (250W RES.HEATERS WITH FAN)	230V AC 50/60 Hz	IP20	152x110x80	TERMINALS
048 095 000803	PFHT 500 (500W RES. HEATERS WITH FAN)	230V AC 50/60 Hz	IP20	182x110x80	TERMINALS
048 095 000804	PFHT 750 (750W RES. HEATERS WITH FAN)	230V AC 50/60 Hz	IP20	232x110x80	TERMINALS
048 095 000805	PFHT 400 (200/300/400W HEATERS WITH FAN)	230V AC 50/60 Hz	IP20	99x70x67	CABLE

EARTHED STICKS AND BARS

COD	DESCRIPTION	PCS
034 025 040001	EARTHING BAR 1 M.	50 ad.
034 025 100001	EARTING BAR (WITH SCREW)	40 ad.

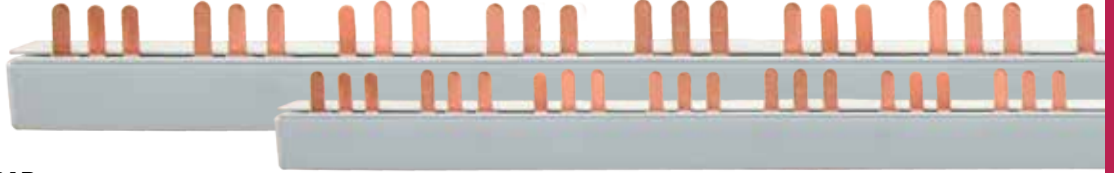

THREE-PHASE COMMON BAR

COD	DESCRIPTION	PCS
034 025 040004	THREE-PHASE COMMON BAR PIN TYPE 53CM	24 ad.
034 025 040006	THREE-PHASE COMMON BAR PIN TYPE 106 CM	24 ad.

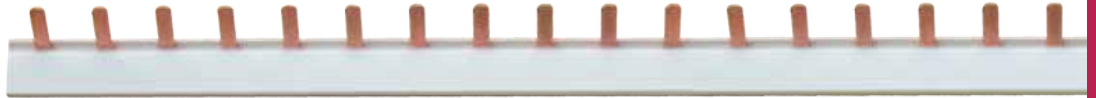

MONOPHASE COMMON BAR

COD	DESCRIPTION	PCS
034 025 040002	MONOPHASE COMMON BAR PIN TYPE 1MT	50 ad.

PIPE FASTENER EARTHED STICK

COD	DESCRIPTION	PCS
091 025 011610	EARTHING STICKS 16 MM 1 MT	10 ad.
091 025 011615	EARTHING STICK 16 MM 1,5 MT	10 ad.
091 025 012010	EARTHING STICK 20 MM 1 MT	5 ad.
091 025 012015	EARTHING STICK 20 MM 1,5 MT	5 ad.

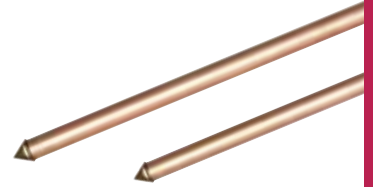

RAILS

COD	DESCRIPTION	PCS
001 025 020100 00 00	TERMINAL STRIPS RAIL(1M)	25 mt.
001 025 000100 00 00	FUSE RAIL(1M)	50 mt.
001 025 000033 00 00	FUSE RAIL(33CM)	50 ad.
001 025 900100 00 00	FUSE RAIL (SLOTTED)(1M)	50 mt.

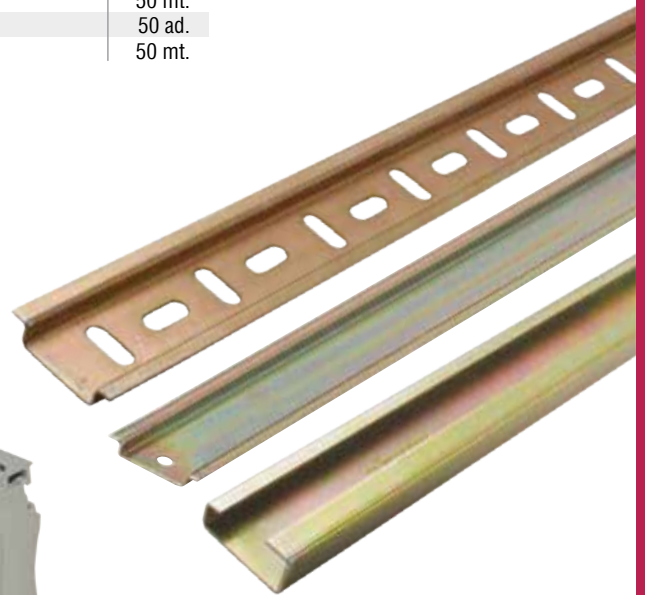
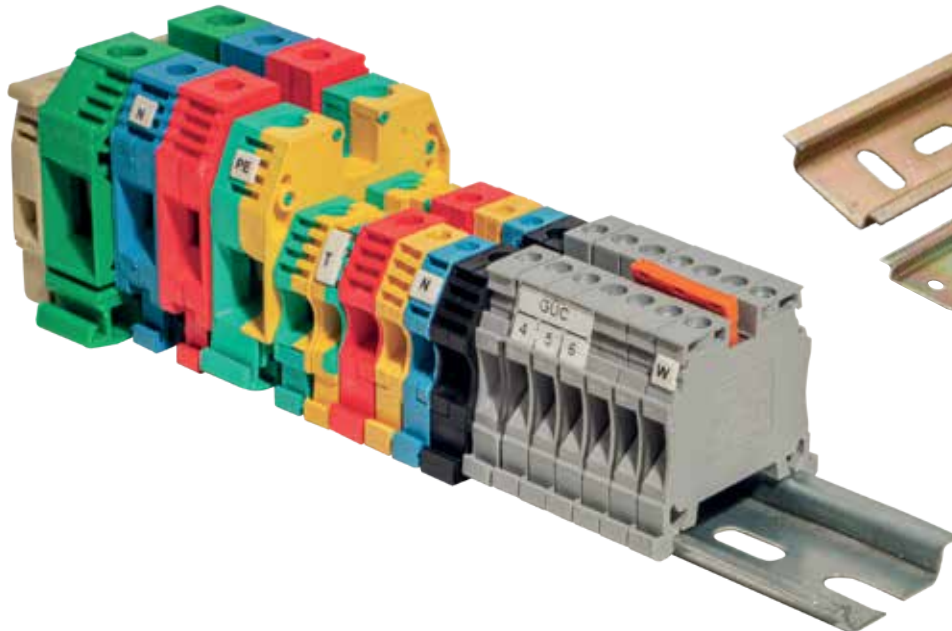



ISOLATED SINGLE INPUT THIMBLE

014 100 010508	ITY-0508 COATED SINGLE TERMINAL 0,50 MM	500 pcs.
014 100 017508	ITY-7508 COATED SINGLE TERMINAL 0,75 MM	1000 pcs.
014 100 011008	ITY-1008 COATED SINGLE TERMINAL 1,00 MM	1000 pcs.
014 100 011508	ITY-1508 COATED SINGLE TERMINAL 1,50 MM	1000 pcs.
014 100 012508	ITY-2508 COATED SINGLE TERMINAL 2,50 MM	500 pcs.
014 100 014009	ITY-4009 COATED SINGLE TERMINAL 4,00 MM	500 pcs.
014 100 016012	ITY-6012 COATED SINGLE TERMINAL 6,00 MM	250 pcs.
014 100 011012	ITY-1012 COATED SINGLE TERMINAL 10,00 MM	100 pcs.
014 100 011612	ITY-1612 COATED SINGLE TERMINAL 16,00 MM	100 pcs.
014 100 012516	ITY-2516 COATED SINGLE TERMINAL 25,00 MM	50 pcs.
014 100 013516	ITY-3516 COATED SINGLE TERMINAL 35,00 MM	40 pcs.
014 100 015020	ITY-5020 COATED SINGLE TERMINAL 50,00 MM	20 pcs.

ISOLATED DOUBLE INPUT THIMBLE

014 100 020508	ICY-0508 COATED DOUBLE TERMINAL 2X0,5 MM	500 pcs.
014 100 027508	ICY-7508 COATED DOUBLE TERMINAL 2X0,75MM	500 pcs.
014 100 021008	ICY-1008 COATED DOUBLE TERMINAL 2X1 MM	500 pcs.
014 100 021508	ICY-1508 COATED DOUBLE TERMINAL 2X1,5 MM	500 pcs.
014 100 022510	ICY-2510 COATED DOUBLE TERMINAL 2X2,5 MM	250 pcs.
014 100 024012	ICY-4012 COATED DOUBLE TERMINAL 2X4 MM	100 pcs.
014 100 026014	ICY-6014 COATED DOUBLE TERMINAL 2X6 MM	100 pcs.

ISOLATED CIRCULAR TYPE LUG

014 100 030154	IYP-1,5-4 COA.RING TY.PAP.0,5-1,5MM (M4)	200 pcs.
014 100 030155	IYP-1,5-5 COA.RING TY. PAP.0,5-1,5MM(M5)	200 pcs.
014 100 030156	IYP-1,5-6 COA.RING TY. PAP.0,5-1,5MM(M6)	200 pcs.
014 100 030158	IYP-1,5-8 COA.RING TY. PAP.0,5-1,5MM(M8)	200 pcs.
014 100 030254	IYP-2,5-4 COA.RING TY.PAP.1,5-2,5MM (M4)	200 pcs.
014 100 030255	IYP-2,5-5 COA.RING TY. PAP.1,5-2,5MM(M5)	200 pcs.
014 100 030256	IYP-2,5-6 COA. RING TY.PAP.1,5-2,5MM(M6)	200 pcs.
014 100 030258	IYP-2,5-8 COA.RING TY. PAP.1,5-2,5MM(M8)	200 pcs.
014 100 036004	IYP-6-4 COATED RING TYPE PAP.4-6MM(M4)	100 pcs.
014 100 036005	IYP-6-5 COATED RING TYPE PAP.4-6 MM(M5)	100 pcs.
014 100 036006	IYP 6-6 COATED RING TYPEPAP.4-6 MM (M6)	100 pcs.
014 100 036008	IYP-6-8 COATED RING TYPE PAP.4-6MM(M8)	100 pcs.

ISOLATED FORK TYPE LUG

014 100 040154	ICP-1,5-4 COA.FORK TY. PAP.0,5-1,5MM(M4)	200 pcs.
014 100 040155	ICP-1,5-5 COA.FORK TY. PAP.0,5-1,5MM(M5)	200 pcs.
014 100 040156	ICP-1,5-6 COA.FORK TY. PAP.0,5-1,5MM(M6)	200 pcs.
014 100 040254	ICP-2,5-4 COA.FORK TY. PAP.0,5-1,5MM(M4)	200 pcs.
014 100 040255	ICP-2,5-5 COA.FORK TY. PAP.0,5-1,5MM(M5)	200 pcs.
014 100 040256	ICP-2,5-6 COA.FORK TY. PAP.0,5-1,5MM(M6)	200 pcs.
014 100 046004	ICP-6-4 COATED FORK TYPE PAP.4-6 MM(M4)	100 pcs.
014 100 046005	ICP-6-5 COATED FORK TYPE PAP.4-6 MM(M5)	100 pcs.
014 100 046006	ICP-6-6 COATED FORK TYPE PAP.4-6 MM(M6)	100 pcs.

ISOLATED NEEDLE TYPE TERMINAL

014 100 050015	IIT-1,5 COATED PIN TYPE TERM.0,5-1,5MM	200 pcs.
014 100 050025	IIT-2,5 COATED PIN TYPE TERM.1,5-2,5MM	200 pcs.
014 100 050040	IIT-4 COATED PIN TYPE TERM.4-6MM	100 pcs.

ISOLATED ADDITIONAL PIPE SOCKET

014 100 070015	IEM-1,5 COA.COUPLER FITTING 0,5-1,5 MM	100 pcs.
014 100 070025	IEM-2,5 COA.COUPLER FITTING 1,5-2,5 MM	100 pcs.
014 100 070040	IEM-4 COATED COUPLER FITTING 4-6 MM	100 pcs.

ISOLATED FASTON MALE TERMINAL

014 100 060015	IFE-1,5 COA.FASTON TYPE MALE TERM.1,5 MM	200 pcs.
014 100 060025	IFE-2,5 COA.FASTON TYPE MALE TERM.2,5 MM	200 pcs.
014 100 060040	IFE-4 COATED FASTON TYPE MALE TERM.4 MM	100 pcs.

ISOLATED FASTON FEMALE TERMINAL

014 100 080510	IDT-0,5-1 COATED TAM FEMALE TERM.0,5-1MM	200 pcs.
014 100 081525	IDT-1,5-2,5 COA.TAM FEMALE TER.1,5-2,5MM	200 pcs.
014 100 084060	IDT-4-6 COATED TAM FEMALE TERM.4-6 MM	100 pcs.

FULL ISOLATED FEMALE TERMINAL

014 100 090510	TDT-0,5-1 TAM COA.FEMALE TERM.0,5-1 MM	200 pcs.
014 100 091525	TDT-1,5-2,5 TAM COA.FEMALE TER.1,5-2,5 M	150 pcs.
014 100 094060	TDT-4-6 TAM COATED FEMALE TERM.4-6 MM	100 pcs.

CIRCULAR FEMALE TERMINAL

014 100 100510	YDT-0,5-1 YUV.FEMALE TERM.0,5-1 MM	200 pcs.
014 100 101525	YDT-1,5-2,5 YUV.FEMALE TERM.1,5-2,5 MM	200 pcs.
014 100 104060	YDT-4-6 YUV.FEMALE TERM.4-6 MM	100 pcs.

CIRCULAR MALE TERMINAL

014 100 110510	YET-0,5-1 YUV.MALE TERM.0,5-1 MM	200 pcs.
014 100 111525	YET-1,5-2,5 YUV.MALE TERM.1,5-2,5 MM	200 pcs.
014 100 114060	YET-4-6 YUV.MALE TERM.4-6 MM	100 pcs.

FASTON TYPE TERMINAL NONISOLATED

065 100 140003	TSF-1-D 6,3 FASTON TYPE TERMINAL NONISOLATED	200 pcs.
065 100 140002	TSF-1-D MINI 4,8 FASTON TYPE TERMINAL NONISOLATED	200 pcs.
065 100 140001	TSF-1-D SILVER FASTON TYPE TERMINAL NONISOLATED	200 pcs.
065 100 140004	TSF-1-E FASTON TYPE TERMINAL NONISOLATED	200 pcs.

TIGHTENING TYPE CABLE LUGS (IMPORT)

COD	DESCRIPTION	CIVATA	D3	D2	D1	L	A	PCS
123 037 000016	16-06 CABLE LUGS (NORMAL SERIES)	M6	6,5	5,8	7,4	30	12	500
123 037 000025	25-08 CABLE LUGS (NORMAL SERIES)	M8	8,5	7	9,2	40	14	350
123 037 000035	35-08 CABLE LUGS (NORMAL SERIES)	M8	8,5	8,2	10,7	44	15,3	200
123 037 000050	50-10 CABLE LUGS (NORMAL SERIES)	M10	10,5	10,2	12,8	52	20	150
123 037 000070	70-10 CABLE LUGS (NORMAL SERIES)	M10	10,5	11,7	14,7	55	22	100
123 037 000095	95-12 CABLE LUGS (NORMAL SERIES)	M12	13	13,6	16,7	59	26	70
123 037 000120	120-12 CABLE LUGS (NORMAL SERIES)	M12	13	15,5	19	70	29	50
123 037 000150	150-12 CABLE LUGS (NORMAL SERIES)	M12	13	16,7	21	77	32	40
123 037 000185	185-16 CABLE LUGS (NORMAL SERIES)	M16	17	18,8	23	85	35	30
123 037 000240	240-16 CABLE LUGS (NORMAL SERIES)	M16	17	21,2	26	90	38,5	24

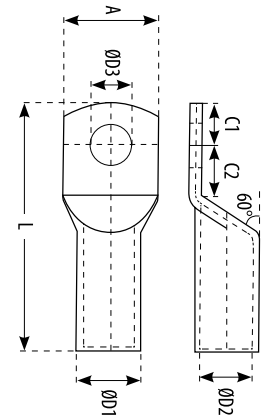

TIGHTENING TYPE CABLE LUGS (STANDART)

COD	DESCRIPTION	CIVATA	D3	D2	D1	L	A	PCS
123 037 500010	10-05 CABLE LUGS (STANDART SERIES)	M5	5,2	4,7	6,5	27,5	10,5	800
123 037 500011	10-06 CABLE LUGS (STANDART SERIES)	M6	6,5	4,7	6,5	27,5	10,5	800
123 037 500012	10-08 CABLE LUGS (STANDART SERIES)	M8	8,5	4,7	6,5	27,5	10,5	800
123 037 500016	16-06 CABLE LUGS (STANDART SERIES)	M6	6,5	5,8	7,4	30	12	500
123 037 500017	16-08 CABLE LUGS (STANDART SERIES)	M8	8,5	5,8	7,8	30	12	500
123 037 500024	25-06 CABLE LUGS (STANDART SERIES)	M6	6,5	7	9,2	40	14	350
123 037 500025	25-08 CABLE LUGS (STANDART SERIES)	M8	8,5	7	9,2	40	14	350
123 037 500026	25-10 CABLE LUGS (STANDART SERIES)	M10	10,5	7	9,5	40	14	350
123 037 500034	35-06 CABLE LUGS (STANDART SERIES)	M6	6,5	8,2	10,7	44	15,3	200
123 037 500035	35-08 CABLE LUGS (STANDART SERIES)	M8	8,5	8,2	10,7	44	15,3	200
123 037 500036	35-10 CABLE LUGS (STANDART SERIES)	M10	10,5	8,2	10,7	44	15,3	200
123 037 500037	35-12 CABLE LUGS (STANDART SERIES)	M12	13	8,2	10,7	44	15,3	200
123 037 500049	50-08 CABLE LUGS (STANDART SERIES)	M8	8,5	10,2	12,8	52	20	150
123 037 500050	50-10 CABLE LUGS (STANDART SERIES)	M10	10,5	10,2	12,8	52	20	150
123 037 500051	50-12 CABLE LUGS (STANDART SERIES)	M12	13	10,2	12,8	52	20	150
123 037 500069	70-08 CABLE LUGS (STANDART SERIES)	M8	8,5	11,7	14,7	55	22	100
123 037 500070	70-10 CABLE LUGS (STANDART SERIES)	M10	10,5	11,7	14,7	55	22	100
123 037 500071	70-12 CABLE LUGS (STANDART SERIES)	M12	13	11,7	14,7	55	22	100
123 037 500093	95-08 CABLE LUGS (STANDART SERIES)	M8	8,5	13,6	16,7	59	26	70
123 037 500094	95-10 CABLE LUGS (STANDART SERIES)	M10	10,5	13,6	16,7	59	26	70
123 037 500095	95-12 CABLE LUGS (STANDART SERIES)	M12	13	13,6	16,7	59	26	70
123 037 500119	120-10 CABLE LUGS (STANDART SERIES)	M10	10,5	15,5	19	70	29	50
123 037 500120	120-12 CABLE LUGS (STANDART SERIES)	M12	13	15,5	19	70	29	50
123 037 500149	150-10 CABLE LUGS (STANDART SERIES)	M10	10,5	16,7	21	77	32	40
123 037 500150	150-12 CABLE LUGS (STANDART SERIES)	M12	13	16,7	21	77	32	40
123 037 500183	185-10 CABLE LUGS (STANDART SERIES)	M10	10,5	18,8	23	85	35	30
123 037 500184	185-12 CABLE LUGS (STANDART SERIES)	M12	13	18,8	23	85	35	30
123 037 500185	185-16 CABLE LUGS (STANDART SERIES)	M16	17	18,8	23	85	35	30
123 037 500238	240-10 CABLE LUGS (STANDART SERIES)	M10	10,5	21,2	26	90	38,5	24
123 037 500239	240-12 CABLE LUGS (STANDART SERIES)	M12	13	21,2	26	90	38,5	24
123 037 500240	240-16 CABLE LUGS (STANDART SERIES)	M16	17	21,2	26	90	38,5	24
123 037 500299	300-12 CABLE LUGS (STANDART SERIES)	M12	13	23,5	28,6	100	43	20
123 037 500300	300-16 CABLE LUGS (STANDART SERIES)	M16	17	23,5	28,6	100	43	20
123 037 500400	400-12 CABLE LUGS (STANDART SERIES)	M12	13	26,8	32,8	108	48	12
123 037 500401	400-16 CABLE LUGS (STANDART SERIES)	M16	17	26,8	32,8	108	48	12
123 037 500402	400-20 CABLE LUGS (STANDART SERIES)	M20	21	26,8	32,8	108	48	12



PIPE TYPE BUTT-CONNECTORS

COD	DESCRIPTION	D2	D1	L	PCS
123 037 300016	Pipe Type Butt-connectors 16MM2	5,8	7,4	30	350
123 037 300025	Pipe Type Butt-connectors 25 MM2	7,2	9,2	40	350
123 037 300035	Pipe Type Butt-connectors 25MM2	8,5	11	44	200
123 037 300050	Pipe Type Butt-connectors 50MM2	10	13	52	150
123 037 300070	Pipe Type Butt-connectors 70MM2	11,5	14,7	55	100
123 037 300095	Pipe Type Butt-connectors 95MM2	13,5	16,7	59	70
123 037 300120	Pipe Type Butt-connectors 120MM2	15,6	19	70	50
123 037 300150	Pipe Type Butt-connectors 150MM2	17	21	77	40
123 037 300185	Pipe Type Butt-connectors 185MM2	19	23	85	30
123 037 300240	Pipe Type Butt-connectors 240MM2	21	26	90	24





RAIL TERMINALS (SCREW TYPE)

COD	DESCRIPTION	PCS
010 094 000025	2.5 MM RAIL TERMINAL BLOCK	100
010 094 000004	4 MM RAIL TERMINAL BLOCK	100
010 094 000006	6 MM RAIL TERMINAL BLOCK	100
010 094 000010	10 MM RAIL TERMINAL BLOCK	100
010 094 000016	16 MM RAIL TERMINAL BLOCK	30
010 094 000035	35 MM RAIL TERMINAL BLOCK	20
010 094 010001	TERMINAL BLOCK STOPPER	100

RAIL TERMINALS (EARTHED)

COD	DESCRIPTION	PCS
010 094 010003	2.5 MM EARTHED RAIL TERMINAL	100
010 094 010008	4 MM EARTHED RAIL TERMINAL	100
010 094 010004	6 MM EARTHED RAIL TERMINAL	100
010 094 010009	10 MM EARTHED RAIL TERMINAL	100
010 094 010005	16 MM EARTHED RAIL TERMINAL	30
010 094 010010	35 MM EARTHED RAIL TERMINAL	20

SPRING TYPE RAIL TERMINAL BLOCKS

COD	DESCRIPTION	PCS
010 094 010011	2.5 MM SPRING TYPE RAIL TER. BLOCKS	100
010 094 010012	4 MM SPRING TYPE RAIL TER. BLOCKS	100
010 094 010013	6 MM SPRING TYPE RAIL TER. BLOCKS	100
010 094 010014	10 MM SPRING TYPE RAIL TER. BLOCKS	100

RAIL TERMINALS (EARTHED)

COD	DESCRIPTION	PCS
010 094 000051	FUSE TERMINAL RAIL	75

NUMBERING ACCESSORIES

COD	DESCRIPTION	PCS
010 094 010006	PRINTED WITH NUMBERS OR LETTERS (1 PCS PRICE)	500
010 094 010007	PRINTLESS (1 PCS PRICE)	500

PANEL EARTHING TERMINALS (6X8mm cross section 63 amp.)

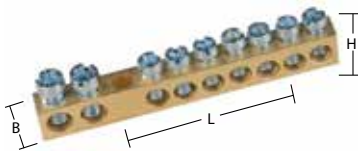

COD	DESCRIPTION	L	B	H	PCS
014 102 006304	4 HOLES PANEL EARTHING TERMINAL	6	8	33	1500
014 102 006305	5 HOLES PANEL EARTHING TERMINAL	6	8	38	1500
014 102 006306	6 HOLES PANEL EARTHING TERMINAL	6	8	45	1250
014 102 006307	7 HOLES PANEL EARTHING TERMINAL	6	8	50	1000
014 102 006309	9 HOLES PANEL EARTHING TERMINAL	6	8	62	1000
014 102 006310	10 HOLES PANEL EARTHING TERMINAL	6	8	68	750
014 102 006312	12 HOLES PANEL EARTHING TERMINAL	6	8	80	750

BOARD EARTHING FREE-STANDING TERMINALS (6,5X9mm cross section 80 amp.)

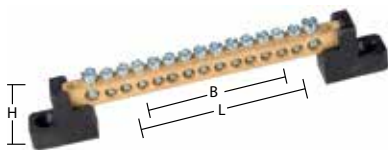

COD	DESCRIPTION	L	B	H	PCS
014 102 008006	6 HOLES FREE-STANDING DIST. UNIT	85	70	22	200
014 102 008010	10 HOLES FREE-STANDING DIST. UNIT	108	95	22	150
014 102 008012	12 HOLES FREE-STANDING DIST. UNIT	120	106	22	150
014 102 008015	15 HOLES FREE-STANDING DIST. UNIT	138	124	22	125
014 102 008020	20 HOLES FREE-STANDING DIST. UNIT	165	152	22	100

125 A. 1 POLE DISTRIBUTION UNIT (7X12 MM)

COD	DESCRIPTION	CİNS	L	B	H	PCS	PRICE
014 102 112507	125 A. 1 POLE DISTRIBUTION UNIT	2+5	76	44	42	70	1,95 \$
014 102 112510	125 A. 1 POLE DISTRIBUTION UNIT	2+8	100	44	42	60	2,32 \$
014 102 112512	125 A. 1 POLE DISTRIBUTION UNIT	2+10	115	44	42	55	2,72 \$
014 102 112515	125 A. 1 POLE DISTRIBUTION UNIT	2+13	135	44	42	45	3,10 \$
014 102 112520	125 A. 1 POLE DISTRIBUTION UNIT	2+18	170	44	42	35	4,34 \$
014 102 112522	125 A. 1 POLE DISTRIBUTION UNIT	2+20	185	44	42	30	4,63 \$

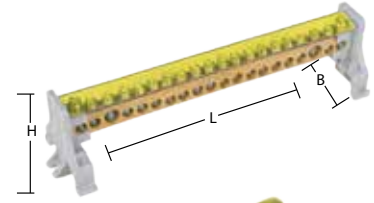

125 A. 2 POLES DISTRIBUTION UNIT (7X12 MM)

COD	DESCRIPTION	CİNS	L	B	H	PCS
014 102 212507	125 A. 2 POLE DISTRIBUTION UNIT	2+5	81	90	50	20
014 102 212510	125 A. 2 POLE DISTRIBUTION UNIT	2+8	103	90	50	16
014 102 212512	125 A. 2 POLE DISTRIBUTION UNIT	2+10	118	90	50	12
014 102 212515	125 A. 2 POLE DISTRIBUTION UNIT	2+13	142	90	50	10
014 102 212520	125 A. 2 POLE DISTRIBUTION UNIT	2+18	178	90	50	8

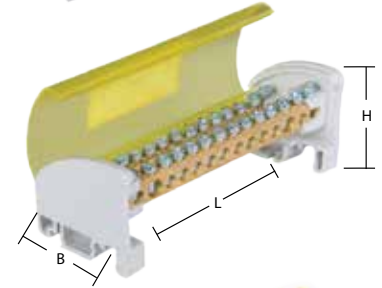

125 A. 4 POLES DISTRIBUTION UNIT (7X12 MM)

COD	DESCRIPTION	CİNS	L	B	H	PCS
014 102 412507	125 A. 4 POLE DISTRIBUTION UNIT	2+5	60	80	75	10
014 102 412510	125 A. 4 POLE DISTRIBUTION UNIT	2+8	83	80	75	8
014 102 412512	125 A. 4 POLE DISTRIBUTION UNIT	2+10	97	80	75	6
014 102 412515	125 A. 4 POLE DISTRIBUTION UNIT	2+13	120	80	75	5
014 102 412520	125 A. 4 POLE DISTRIBUTION UNIT	2+18	155	80	75	4
014 102 412522	125 A. 4 POLE DISTRIBUTION UNIT	2+20	170	80	75	4
014 102 412525	125 A. 4 POLE DISTRIBUTION UNIT	2+23	191	80	75	4

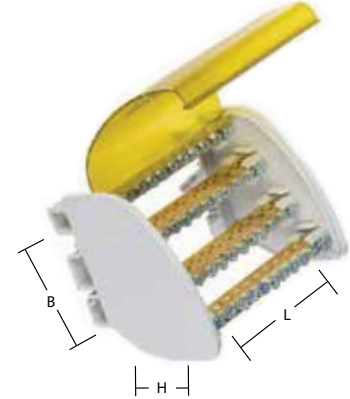

3 POLES 10X15 CROSS SECTION 160 AMP. DISTRIBUTION UNIT

COD	DESCRIPTION	CİNS	L	B	H	PCS
014 102 316007	160 A. 3 POLE DISTRIBUTION UNIT	2+5	105	130	55	12
014 102 316010	160 A. 3 POLE DISTRIBUTION UNIT	2+8	145	130	55	8
014 102 316012	160 A. 3 POLE DISTRIBUTION UNIT	2+10	165	130	55	8
014 102 316015	160 A. 3 POLE DISTRIBUTION UNIT	2+13	200	130	55	6
014 102 316020	160 A. 3 POLE DISTRIBUTION UNIT	2+18	255	130	55	4
014 102 316022	160 A. 3 POLE DISTRIBUTION UNIT	2+20	275	130	55	4

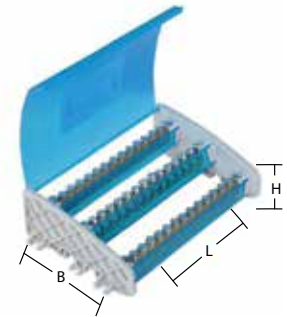

4 POLES 10X15 CROSS SECTION 160 AMP. DISTRIBUTION UNIT

COD	DESCRIPTION	CİNS	L	B	H	PCS
014 102 416007	160 A. 4 POLE DISTRIBUTION UNIT	2+5	105	144	55	12
014 102 416010	160 A. 4 POLE DISTRIBUTION UNIT	2+8	145	144	55	8
014 102 416012	160 A. 4 POLE DISTRIBUTION UNIT	2+10	165	144	55	8
014 102 416015	160 A. 4 POLE DISTRIBUTION UNIT	2+13	200	144	55	6
014 102 416020	160 A. 4 POLE DISTRIBUTION UNIT	2+18	255	144	55	4
014 102 416022	160 A. 4 POLE DISTRIBUTION UNIT	2+20	275	144	55	4

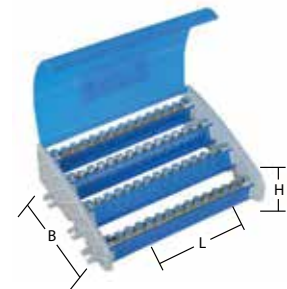

5 POLES 10X15 CROSS SECTION 160 AMP. DISTRIBUTION UNIT

COD	DESCRIPTION	CİNS	L	B	H	PCS
014 102 516007	160 A. 5 POLE DISTRIBUTION UNIT	2+5	105	151	95	8
014 102 516010	160 A. 5 POLE DISTRIBUTION UNIT	2+8	145	151	95	4
014 102 516012	160 A. 5 POLE DISTRIBUTION UNIT	2+10	165	151	95	4
014 102 516015	160 A. 5 POLE DISTRIBUTION UNIT	2+13	200	151	95	4
014 102 516020	160 A. 5 POLE DISTRIBUTION UNIT	2+18	255	151	95	4
014 102 516022	160 A. 5 POLE DISTRIBUTION UNIT	2+20	275	151	95	4

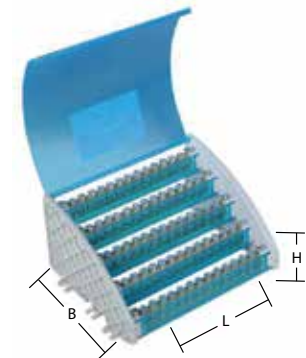

NEW

PUSH BUTTON PLASTIC



CODE
010 104 000003
DESCRIPTION
SW-AA42 22 MM
PUSH BUTTON RED
-OFF -1NC
PACKAGE
10



CODE
010 104 000004
DESCRIPTION
SW-AA31 22MM
Ø22 MM PUSH BUTTON
GREEN-ON -1NO
PACKAGE
10



CODE
010 104 000005
DESCRIPTION
SW-AA51 22MM
PUSH BUTTON YELLOW
ON -1NO
PACKAGE
10



CODE
010 104 000006
DESCRIPTION
SW-AA61 22MM
PUSH BUTTON BLUE
ON -1NO
PACKAGE
10



CODE
010 104 000007
DESCRIPTION
SW-AA21 22MM
PUSH BUTTON BLACK
ON -1NO
PACKAGE
10



CODE
010 104 000008
DESCRIPTION
SW-AA11 22MM
PUSH BUTTON WHITE
ON -1NO
PACKAGE
10

PUSH BUTTON PLASTIC



CODE
010 104 000009
DESCRIPTION
SW-AA4322 22MM
PUSH BUTTON RED
ON -1NC
PACKAGE
10



CODE
010 104 000010
DESCRIPTION
SW-AA3361 22MM
PUSH BUTTON BLUE
ON -1NC
PACKAGE
10



CODE
010 104 000011
DESCRIPTION
SW-AA3351 22MM
PUSH BUTTON BLACK
OFF -1NC
PACKAGE
10



CODE
010 104 000012
DESCRIPTION
SW-AA3341 22MM
PUSH BUTTON WHITE
ON -1NC
PACKAGE
10



CODE
010 104 000013
DESCRIPTION
SW-AA3371 22MM
PUSH BUTTON YELLOW
ON -1NC
PACKAGE
10



CODE
010 104 000014
DESCRIPTION
SW-AA3381 22MM
PUSH BUTTON WHITE
ON -1NC
PACKAGE
10

swiss

NEW

DOUBLE PUSH BUTTON PLASTIC



CODE
010 104 000015
DESCRIPTION
SW-AL7325 22 MM LED
DOUBLE PUSH BUTTON
1-ON-1OFF (1NO-1NC)
PACKAGE
10



CODE
010 104 000016
DESCRIPTION
SW-AL7181 22 MM
DOUBLE PUSH BUTTON
ON-OFF(1NO-1NO)
PACKAGE
10



CODE
010 104 000017
DESCRIPTION
SW-AL4252 22 MM
DOUBLE PUSH BUTTON
ON-OFF(1NO-1NO)
PACKAGE
10



CODE
010 104 000018
DESCRIPTION
SW-AL6171 22 MM
DOUBLE PUSH BUTTON
ON-OFF(1NO-1NO)
PACKAGE
10



CODE
010 104 000019
DESCRIPTION
SW-AL6181 22 MM
DOUBLE PUSH BUTTON
ON-OFF(1NO-1NO)
PACKAGE
10



CODE
010 104 000020
DESCRIPTION
SW-AL7425 22 MM
DOUBLE PUSH BUTTON
ON-OFF(1NO-1NO)
PACKAGE
10



CODE
010 104 000021
DESCRIPTION
SW-AL7525 22 MM
DOUBLE PUSH BUTTON
ON-OFF(1NO-1NC)
PACKAGE
10



CODE
010 104 000022
DESCRIPTION
SW-AL4151 22 MM
DOUBLE PUSH BUTTON
ON-OFF(1NO-1NO)
PACKAGE
10



CODE
010 104 000023
DESCRIPTION
SW-AL7465L 22 MM
LED DOUBLE PUSH
BUTTON ON-OFF 220V
PACKAGE
10



CODE
010 104 000024
DESCRIPTION
SW-AL7465-24L 22 MM
LED DOUBLE PUSH
BUTTON ON-OFF 24V
PACKAGE
10

swiss

NEW

SELECTOR SWITCH PLASTIC



CODE
010 104 000025
DESCRIPTION
SW-AD21 0-1 SELEC-
TOR SWITCH ON -OFF
(1NO)
PACKAGE
10



CODE
010 104 000026
DESCRIPTION
SW-AD41 0-1 SELEC-
TOR SWITCH ON -OFF
(1NC)
PACKAGE
10



CODE
010 104 000027
DESCRIPTION
SW-AD33 1-0-2
SELECTOR SWITCH
ON-OFF (2NO)
PACKAGE
10



CODE
010 104 000028
DESCRIPTION
SW-AD53 1-0-2
SELECTOR SWITCH
ON-OFF (2NC)
PACKAGE
10

SELECTOR SWITCH WITH KEY



CODE
010 104 000029
DESCRIPTION
SW-AG21 0-1 SELEC-
TOR SWITCH WITH KEY
(1NO)
PACKAGE
10



CODE
010 104 000030
DESCRIPTION
SW-AG41 0-1 SELEC-
TOR SWITCH WITH KEY
(1NC)
PACKAGE
10



CODE
010 104 000031
DESCRIPTION
SW-AG33 1-0-2
SELECTOR SWITCH
WITH KEY (1NO+1NO)
PACKAGE
10



CODE
010 104 000032
DESCRIPTION
SW-AG53 1-0-2
SELECTOR SWITCH
WITH KEY (1NC+1NC)
PACKAGE
10

EMERGENCY STOP



CODE
010 104 000037
DESCRIPTION
SW-AC42 EMERGENCY
STOP BUTTON OFF
1NC RED
PACKAGE
10



CODE
010 104 000038
DESCRIPTION
SW-AC31 22 MM
EMERGENCY BUTTON
ON -1NO GREEN
PACKAGE
10



CODE
010 104 000039
DESCRIPTION
SW-AC51 22 MM
EMERGENCY BUTTON
ON -1NO YELLOW
PACKAGE
10

swiss

NEW
EMERGENCY STOP

CODE
010 104 000033
DESCRIPTION
SW-AS142 40 MM
EMERGENCY STOP
WITH KEY
PACKAGE
10



CODE
010 104 000034
DESCRIPTION
SW-AS542E 40 MM
EMERGENCY STOP
BUTTON STOPE 1NC
PACKAGE
10



CODE
010 104 000035
DESCRIPTION
SW-AS542 40 MM
EMERGENCY STOP
BUTTON OFF 1NC
PACKAGE
10



CODE
010 104 000036
DESCRIPTION
SW-AS442 30 MM
EMERGENCY STOP
BUTTON STOPE1NO
PACKAGE
10

LED PUSH BUTOON PLASTIC - IP50

CODE
010 104 000040
DESCRIPTION
SW-AW3475
Ø22 mm PUSH BUTTON
LED R (1NC)
110-240VAC
PACKAGE
10
PRICE
2,76 \$



CODE
010 104 000041
DESCRIPTION
SW-AW3475-24
Ø22 mm PUSH BUTTON
LED R (1NC)
10-30VAC-DC
PACKAGE
10
PRICE
2,76 \$



CODE
010 104 000042
DESCRIPTION
SW-AW3375
Ø22 mm PUSH BUTTON
LED GR (1NO)
110-240VAC
PACKAGE
10
PRICE
2,76 \$



CODE
010 104 000043
DESCRIPTION
SW-AW3375-24
Ø22 mm PUSH BUTTON
LED GR (1NO)
10-30VAC-DC
PACKAGE
10
PRICE
2,76 \$



CODE
010 104 000044
DESCRIPTION
SW-AW3575
Ø22 mm PUSH BUTTON
LED Y (1NO)
110-240VAC
PACKAGE
10
PRICE
2,76 \$



CODE
010 104 000045
DESCRIPTION
SW-AW3575-24
Ø22 mm PUSH BUTTON
LED Y (1NO)
10-30VAC-DC
PACKAGE
10
PRICE
2,76 \$



CODE
010 104 000046
DESCRIPTION
SW-AW3675
Ø22 mm PUSH BUTTON
LED BL (1NO)
110-240VAC
PACKAGE
10
PRICE
2,76 \$



CODE
010 104 000047
DESCRIPTION
SW-AW3675-24
Ø22 mm PUSH BUTTON
LED BL (1NO)
10-30VAC-DC
PACKAGE
10
PRICE
2,76 \$

swiss

NEW

0-1 LED SELECTOR SWITCH



CODE
010 104 000048
DESCRIPTION
SW-AK123L
0-1 LED SELECTOR
SWITCH G (1NO)
110-240VAC
PACKAGE
10



CODE
010 104 000049
DESCRIPTION
SW-AK124L
0-1 LED SELECTOR
SWITCH R (1NC)
110-240VAC
PACKAGE
10



CODE
010 104 000050
DESCRIPTION
SW-AK125L
0-1 LED SELECTOR
SWITCH Y (1NO)
110-240VAC
PACKAGE
10



CODE
010 104 000051
DESCRIPTION
SW-AK123-24L
0-1 LED SELECTOR
SWITCH G (1NO)
10-30VAC-DC
PACKAGE
10



CODE
010 104 000052
DESCRIPTION
SW-AK124-24L
0-1 LED SELECTOR
SWITCH R (1NC)
10-30VAC-DC
PACKAGE
10



CODE
010 104 000053
DESCRIPTION
SW-AK125-24L
0-1 LED SELECTOR
SWITCH Y (1NO)
10-30VAC-DC
PACKAGE
10

1-0-2 LED SELECTOR SWITCH



CODE
010 104 000054
DESCRIPTION
SW-AK323L 1-0-2 LED
SELECTOR SWITCH G
(1NO) 110-240VAC
PACKAGE
10



CODE
010 104 000055
DESCRIPTION
SW-AK324L 1-0-2 LED
SELECTOR SWITCH R
(1NC) 110-240VAC
PACKAGE
10



CODE
010 104 000056
DESCRIPTION
SW-AK325L 1-0-2 LED
SELECTOR SWITCH Y
(1NO) 110-240VAC
PACKAGE
10



CODE
010 104 000057
DESCRIPTION
1-0-2 LED SELECTOR
SWITCH G (1NO)
10-30VAC-DC
PACKAGE
10



CODE
010 104 000058
DESCRIPTION
SW-AK324-24L 1-0-2
LED SELECTOR SWIT.
R (1NC) 10-30 VAC-DC
PACKAGE
10



CODE
010 104 000059
DESCRIPTION
SW-AK325-24L 1-0-2
LED SELECTOR SWIT.
Y (1NO) 10-30VAC-DC
PACKAGE
10

POTENTIOMETER



CODE
010 104 000001
DESCRIPTION
MS22-5K
POTANS 5K

PACKAGE
15



CODE
010 104 000002
DESCRIPTION
MS22-10K
POTANS 10K

PACKAGE
15

swiss

NEW

PUSH BUTTON MATTEL- IP65



CODE
010 104 000064
DESCRIPTION
SW-BA42
22 MM PUSH BUTTON
ON R (1NO)
PACKAGE
10



CODE
010 104 000065
DESCRIPTION
SW-BA31
22 MM PUSH BUTTON
ON G (1NO)
PACKAGE
10



CODE
010 104 000066
DESCRIPTION
SW-BA51
22 MM PUSH BUTTON
ON Y (1NO)
PACKAGE
10



CODE
010 104 000067
DESCRIPTION
SW-BA11
22 MM PUSH BUTTON
ON W (1NO)
PACKAGE
10



CODE
010 104 000068
DESCRIPTION
SW-BA61
22 MM PUSH BUTTON
ON BL (1NO)
PACKAGE
10



CODE
010 104 000069
DESCRIPTION
SW-BA21
22 MM PUSH BUTTON
BLACK ON (1NO)
PACKAGE
10

PUSH BUTTON MATTEL PRINTING- IP65



CODE
010 104 000071
DESCRIPTION
SW-BA4322
PUSH BUTTON MATTEL
PRIN. OFF (1NC) RED
PACKAGE
10



CODE
010 104 000072
DESCRIPTION
SW-BA3351
PUSH BUTTON MATTEL
PRIN. ON (1NO)BLACK
PACKAGE
10



CODE
010 104 000073
DESCRIPTION
SW-BA3341
PUSH BUTTON MATTEL
PRIN. ON (1NO) WHITE
PACKAGE
10



CODE
010 104 000074
DESCRIPTION
SW-BA3361
PUSH BUTTON MATTEL
PRIN. ON (1NO) BLUE
PACKAGE
10



CODE
010 104 000075
DESCRIPTION
SW-BA3371
PUSH BUTTON MATTEL
PRIN. ON(1NO)YELLOW
PACKAGE
10



CODE
010 104 000076
DESCRIPTION
SW-BA3381
PUSH BUTTON MATTEL
PRIN. ON (1NO)
PACKAGE
10

MATTEL DOUBALE PUSH BUTOON -IP 65



CODE
010 104 000077
DESCRIPTION
SW-BL7325
22 MM DOUBALE PUSH
NO PRINT (1NO/1NC)
PACKAGE
10



CODE
010 104 000078
DESCRIPTION
SW-BL7425 22 MM
DOUBALE PUSH
PRINTING (1NO/1NC)
PACKAGE
10



CODE
010 104 000079
DESCRIPTION
SW-BL7525 22 MM
DOUBALE PUSH
PRINTING (1NO/1NC)
PACKAGE
10

swiss

NEW

MATTEL DOUBALE PUSH BUTOON -IP 65



CODE
010 104 000080
DESCRIPTION
SW-BL4151 22 MM
DOUBALE PUSH
PRINTING (1NO/1NC)
PACKAGE
10



CODE
010 104 000081
DESCRIPTION
SW-BL4252 22 MM
DOUBALE PUSH
PRINTING (1NO/1NC)
PACKAGE
10



CODE
010 104 000082
DESCRIPTION
SW-BL6171 22 MM
DOUBALE PUSH
PRINTING (1NO/1NC)
PACKAGE
10



CODE
010 104 000083
DESCRIPTION
SW-BL7181 22 MM
DOUBALE PUSH
PRINTING (1NO/1NC)
PACKAGE
10



CODE
010 104 000084
DESCRIPTION
SW-BL6181 22 MM
DOUBALE PUSH
PRINTING (1NO/1NC)
PACKAGE
10



CODE
010 104 000085
DESCRIPTION
SW-BL7465L 22 MM
DOUBALE PUSH LED
220V (1NO/1NC)
PACKAGE
10



CODE
010 104 000086
DESCRIPTION
SW-BL7465-24L 22 MM
DOUBALE PUSH LED
24V (1NO/1NC)
PACKAGE
10

MATTEL SELECTOR SWITCH



CODE
010 104 000087
DESCRIPTION
SW-BD21
0-1 SELECTOR SWITCH
ON-OFF (1NO)
PACKAGE
10



CODE
010 104 000088
DESCRIPTION
SW-BD41
0-1 SELECTOR SWITCH
ON-OFF (1NC)
PACKAGE
10



CODE
010 104 000089
DESCRIPTION
SW-BD33
1-0-2 SELECTOR
SWITCH ON-OFF (2NO)
PACKAGE
10



CODE
010 104 000090
DESCRIPTION
SW-BD53
1-0-2 SELECTOR
SWITCH ON-OFF (2NC)
PACKAGE
10

swiss

NEW

LED PUSH BUTOON PLASTIC METAL - IP50



CODE
010 104 000160
DESCRIPTION
SW-BW3475
Ø22 mm PUSH BUTTON
LED R (110-240)VAC
PACKAGE
10



CODE
010 104 000161
DESCRIPTION
SW-BW3475-24L
Ø22 mm PUSH BUTTON
LED R (10-30)VAC-DC
PACKAGE
10



CODE
010 104 000162
DESCRIPTION
SW-BW3375
Ø22 mm PUSH BUTTON
LED GR (110-240)VAC
PACKAGE
10



CODE
010 104 000163
DESCRIPTION
SW-BW3375-24L
Ø22 mm PUSH BUTTON
LED GR (10-30)VAC-DC
PACKAGE
10



CODE
010 104 000164
DESCRIPTION
SW-BW3575
Ø22 mm PUSH BUTTON
LED Y (110-240)VAC
PACKAGE
10



CODE
010 104 000165
DESCRIPTION
SW-BW3575-24L
Ø22 mm PUSH BUTTON
LED Y (10-30)VAC-DC
PACKAGE
10



CODE
010 104 000166
DESCRIPTION
SW-BW3675
Ø22 mm PUSH BUTTON
LED BL (110-240)VAC
PACKAGE
10



CODE
010 104 000167
DESCRIPTION
SW-BW3675-24L
Ø22 mm PUSH BUTTON
LED BL (10-30)VAC-DC
PACKAGE
10

0-1 LED SELECTTOR SWITCH METAL



CODE
010 104 000168
DESCRIPTION
SW-BK123L
0-1 LED SELECTTOR
SWITCH G (1NO)
110-240VAC
PACKAGE
10



CODE
010 104 000169
DESCRIPTION
SW-BK124L
0-1 LED SELECTTOR
SWITCH R (1NC)
110-240VAC
PACKAGE
10



CODE
010 104 000170
DESCRIPTION
SW-BK125L
0-1 LED SELECTTOR
SWITCH Y (1NO)
110-240VAC
PACKAGE
10



CODE
010 104 000171
DESCRIPTION
SW-BK123-24L
0-1 LED SELECTTOR
SWITCH G (1NO)
10-30VAC-DC
PACKAGE
10



CODE
010 104 000172
DESCRIPTION
SW-BK124-24L
0-1 LED SELECTTOR
SWITCH R (1NC)
10-30VAC-DC
PACKAGE
10



CODE
010 104 000173
DESCRIPTION
SW-BK125-24L
0-1 LED SELECTTOR
SWITCH Y (1NO)
10-30VAC-DC
PACKAGE
10

swiss

NEW

1-0-2 LED SELECTOR SWITCH METAL



CODE
010 104 000174
DESCRIPTION
SW-BK323L
1-0-2 LED SELECTOR
SWITCH G (2NO)
110-240VAC
PACKAGE
10



CODE
010 104 000175
DESCRIPTION
SW-BK324L
1-0-2 LED SELECTOR
SWITCH R (2NC)
110-240VAC
PACKAGE
10



CODE
010 104 000176
DESCRIPTION
SW-BK325L
1-0-2 LED SELECTOR
SWITCH Y (2NO)
110-240VAC
PACKAGE
10



CODE
010 104 000177
DESCRIPTION
SW-BK323-24L 1-0-2
LED SELECTOR
SWITCH G (2NO)
10-24VAC-DC
PACKAGE
10



CODE
010 104 000178
DESCRIPTION
SW-BK324-24L
1-0-2 LED SELECTOR
SWITCH R (2NC)
10-24VAC-DC
PACKAGE
10



CODE
010 104 000179
DESCRIPTION
SW-BK325-24L
1-0-2 LED SELECTOR
SWITCH Y (2NO)
10-24VAC-DC
PACKAGE
10

AUXILIARY CONTACT



CODE
010 104 000060
DESCRIPTION
SW-BE101
AUXILIARY CONTACT
(1NO)
PACKAGE
50



CODE
010 104 000061
DESCRIPTION
SW-BE102
AUXILIARY CONTACT
(1NC)
PACKAGE
50



CODE
010 104 000062
DESCRIPTION
SW-BE103
AUXILIARY LED
CONTACT
PACKAGE
50

PLACTIC COVER BUTTON

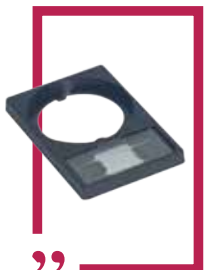

CODE
010 104 000091
DESCRIPTION
SW-BR1
PLACTIC COVER
BUTTON 26X8mm
PACKAGE
100

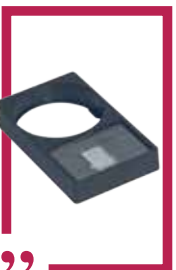

CODE
010 104 000092
DESCRIPTION
SW-BR2
PLACTIC COVER
BUTTON 26X18mm
PACKAGE
100

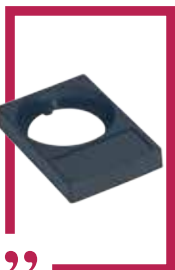

CODE
010 104 000093
DESCRIPTION
SW-SIE-R
PLACTIC COVER
BUTTON 22mm
PACKAGE
100



CODE
010 093 000002
DESCRIPTION
SW-BRY
BUTTON LABEL
PACKAGE
100



CODE
010 093 000001
DESCRIPTION
SW-AP2 IP67
SILICONE DUST COVER
PACKAGE
10



CODE
010 104 000099
DESCRIPTION
SW-AP4 IP67 TWIN
BUTTON PROTECTION
CASE (FOR SPRING BUT.)
PACKAGE
10

swiss

NEW

EMERGENCY STOP COVER

CODE
010 104 000095
DESCRIPTION
SW-ER60TE
EMERGENCY STOP PANEL
LABELS FRAME Ø60 MM
PACKAGE
100



CODE
010 104 000096
DESCRIPTION
SW-ER60EN-Y Ø60 MM
EMERGENCY STOP PANEL
LABELS FRAME Ø60 MM
PACKAGE
100



CODE
010 093 000003
DESCRIPTION
EMERGENCY STOP
LABEL
PACKAGE
100



CODE
010 090 050008
DESCRIPTION
SW-AKKM EMERGENCY
STOP PROTECTIVE
COVER 22mm
PACKAGE
10



CODE
010 104 000101
DESCRIPTION
SW-AKK EMERGENCY
STOP PROTECTIVE
COVER
PACKAGE
10



CODE
010 104 000102
DESCRIPTION
SW-AKKY EMERGENCY
STOP PROTECTIVE
COVER
PACKAGE
10



CODE
010 104 000103
DESCRIPTION
SW-ASKK EMERGENCY
STOP PROTECTIVE
COVER
PACKAGE
10



CODE
010 104 000104
DESCRIPTION
SW-MKKY EMERGENCY
STOP PROTECTIVE
COVER 22mm
PACKAGE
10

VOLTMETRE ve AMPERMETRE

CODE
999 999 995000
DESCRIPTION
22 mm voltmeter plastic
LED Indicator 12-500V
AC
PACKAGE
10



CODE
999 999 995001
DESCRIPTION
22 mm Ammeter (with
current transformer)
plastic LED indicator
1A-100A AC 6-380V AC
PACKAGE
10



CODE
999 999 995002
DESCRIPTION
22 mm Voltmeter + Ammeter
(Current trans.) with plastic
LED indicator 12-500v AC
1A-100a AC
PACKAGE
10

BUTTON SWITCHES

CODE
010 104 000063
DESCRIPTION
MS-1010
1NO
PACKAGE
50





















CODE
010 104 000193
DESCRIPTION
MS-1011
1NK
PACKAGE
50



CODE
010 104 000194
DESCRIPTION
MS-1012
1NA+1NK
PACKAGE
50

SWISS

PANEL SIGNALS AND BUTTONS

 <p>CODE 010 090 010001 DESCRIPTION 10 MM SIGNAL ARMA- TURE WITH CABLE PACKAGE 100</p> <p>CE</p>	 <p>CODE 010 090 010005 DESCRIPTION 14MM SIGNAL ARMATURE 12V PACKAGE 50</p> <p>CE</p>	 <p>CODE 010 090 010006 DESCRIPTION 14MM SIGNAL ARMATURE 24V PACKAGE 50</p> <p>CE</p>
 <p>CODE 010 090 010007 DESCRIPTION 14MM SIGNAL ARMATURE 220V PACKAGE 50</p> <p>CE</p>	 <p>CODE 010 090 010008 DESCRIPTION 22MM SIGNAL ARMATURE 12V PACKAGE 24</p> <p>CE</p>	 <p>CODE 010 090 010009 DESCRIPTION 22MM SIGNAL ARMATURE 24V PACKAGE 24</p> <p>CE</p>
 <p>CODE 010 090 010010 DESCRIPTION 22MM SIGNAL ARMATURE 220V PACKAGE 24</p> <p>CE</p>	 <p>CODE 010 090 010004 DESCRIPTION 22MM LED SIGNAL ARMATURE 220V PACKAGE 24</p> <p>CE</p>	 <p>CODE 010 090 070002 DESCRIPTION 22MM LED SIGNAL ARMATURE 24V PACKAGE 24</p> <p>CE</p>
 <p>CODE 010 090 010002 DESCRIPTION BAS9S DYLAN LED LIGHT SOCKET ADAPTER PACKAGE 24</p> <p>CE</p>	 <p>CODE 010 111 070001 DESCRIPTION BUZZER 220 VOLT LEDLI PACKAGE 24</p>	 <p>CODE 010 111 070002 DESCRIPTION BUZZER 24 VOLT LEDLI PACKAGE 24</p>
 <p>CODE 010 111 070003 DESCRIPTION BUZZER 220 VOLT PACKAGE 24</p>	 <p>CODE 010 111 070004 DESCRIPTION BUZZER 24 VOLT PACKAGE 24</p>	 <p>CODE 010 090 050003 DESCRIPTION BA9S LED CHIP ILLUMINATED START B. PACKAGE 20</p>
 <p>CODE 010 090 030003 DESCRIPTION BA9S W.LED ILLUM. SELLECTING BUTTON 0-1 PACKAGE 12</p>	 <p>CODE 010 090 030004 DESCRIPTION BA9S W.LED ILLUM. SELLEC. BUTTON 11-0-1 PACKAGE 12</p>	 <p>CODE 010 090 050005 DESCRIPTION BA9S NEON SPRING ILLUMINATED STOP B. PACKAGE 20</p>

NEW

BUTTON in HOIST



CODE
010 104 000120
DESCRIPTION
MS-KK31
PUSH BUTTON ON IN
HOIST (1NO) GREEN
PACKAGE
20



CODE
010 104 000121
DESCRIPTION
MS-KK42
PUSH BUTTON OFF IN
HOIST (1NC) RED
PACKAGE
20



CODE
010 104 000122
DESCRIPTION
MS-KK51
PUSH BUTTON ON IN
HOIST (1NO) YELLOW
PACKAGE
20



CODE
010 104 000123
DESCRIPTION
MS-BX71
PUSH BUT. ON IN HOIST
(1NO) PRIN. YELLOW
PACKAGE
20



CODE
010 104 000124
DESCRIPTION
MS-BX81 1'LI
PUSH BUT. ON IN HOIST
(1NO) PRIN. YELLOW
PACKAGE
20



CODE
010 104 000125
DESCRIPTION
MS-KK7325
DOUBLE PUSH BUTTON
ON-OFF(1NO-1NO) PRIN.
PACKAGE
20



CODE
010 104 000126
DESCRIPTION
MS-KK4151 1'LI
DOUBLE PUSH BUTTON
ON-OFF(1NO-1NO) PRIN.
PACKAGE
20



CODE
010 104 000127
DESCRIPTION
MS-KBZ
LED BUZZER IN HOIST
PACKAGE
20



CODE
010 090 050009
DESCRIPTION
MS-BX542
EMERGENCY STOP IN
HOIST
PACKAGE
18



CODE
010 104 000129
DESCRIPTION
MS-BX542E
EMERGENCY STOP IN
HOIST PRINTING
PACKAGE
18



CODE
010 104 000130
DESCRIPTION
MS-BX542ASP EMER-
GENCY STOP IN HOIST
WITH(Protective Cover)
PACKAGE
12



CODE
010 104 000131
DESCRIPTION
MS-BYP3K
KEY SELECTOR SWITCH
IN HOIST
PACKAGE
12



CODE
010 104 000132
DESCRIPTION
MS-BY4K
KEY SELECTOR SWITCH
IN HOIST
PACKAGE
12



CODE
010 104 000133
DESCRIPTION
MS-KANT 1'LI
RESET BUTTON IN
HOIST
PACKAGE
18

swiss

NEW

EKO SERIES CONTROL BOXES

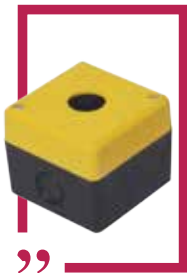

CODE
010 104 000105
DESCRIPTION
EKO 1 GANG
EMPTY CONTROL BOX
PACKAGE
90



CODE
010 104 000106
DESCRIPTION
EKO 1 GANG
PROTECTED EMPTY
CONTROL BOX
PACKAGE
50



CODE
010 104 000107
DESCRIPTION
EKO 1 GANG EMER-
GENCY STOP LAB.
MARKED CONTROL BOX
PACKAGE
50



CODE
010 104 000156
DESCRIPTION
EKO 1 GANG
EMERGENCY STOP
CONTROL BOX
PACKAGE
50

BUTTON HOIST



CODE
010 091 010001
DESCRIPTION
HOIST 1 HOLDER
PACKAGE
24



CODE
010 091 010002
DESCRIPTION
HOIST 2 HOLDER
PACKAGE
18



CODE
010 091 010003
DESCRIPTION
HOIST 2 HOLDER
PACKAGE
12



CODE
010 091 010004
DESCRIPTION
HOIST 4 HOLDER
PACKAGE
10



CODE
010 104 000114
DESCRIPTION
SW-BX05SB
HOIST 5 HOLDER
EMPTY
PACKAGE
8

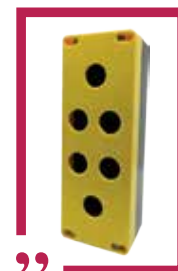

CODE
010 104 000115
DESCRIPTION
SW-BX06SB
HOIST 6 HOLDER
EMPTY
PACKAGE
8

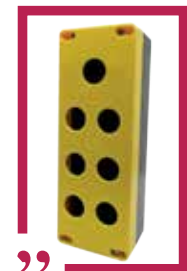

CODE
010 104 000116
DESCRIPTION
SW-BX07SB
HOIST 7 HOLDER
EMPTY
PACKAGE
6



CODE
010 104 000117
DESCRIPTION
SW-BX08SB
HOIST 8 HOLDER
EMPTY
PACKAGE
6



CODE
010 104 000118
DESCRIPTION
SW-BX09SB
HOIST 9 HOLDER
EMPTY
PACKAGE
1



CODE
010 104 000119
DESCRIPTION
SW-BX10S
HOIST 10 HOLDER
EMPTY
PACKAGE
1

NEW

ELEVATOR PIT SETS AND CONTROL BUTTONS



CODE
010 104 000134
DESCRIPTION
2 GANG ELEVATOR PIT
BUTTON 220 V 16A EARTED
SOCKET+EMERGENCY STOP
BUTTON
PACKAGE
9



CODE
010 104 000135
DESCRIPTION
EMERGENCY STOP BUTTON +
SELECT BUT. (2NO) 220v 16A
EARTED PANEL SOCKET
PACKAGE
6



CODE
010 104 000136
DESCRIPTION
MS-KYD04 6 GANG
EMERGENCY STOP BUTTON
+2 PIECES OF ARROWED BUT.
(1NO) 1 TWIN BUT. (2NO) 1
SELECT BUT.(2NO)
PACKAGE
5



CODE
010 104 000137
DESCRIPTION
MS-KYD05 EMERGENCY STOP
BUT. + 2 ARROWED BUTTON
COMMON ARROWED (1NO)
SELECT BUTTON (2NO-1NC)
PACKAGE
4



CODE
010 104 000138
DESCRIPTION
MS-KYD06 EMERGENCY STOP
+2 ARROWED BUT. (2NO) 1
COMMON BUT. (1NO) ALARM
BUT. + SEL. BUT. (2NO-1NC)
PACKAGE
2



CODE
010 104 000139
DESCRIPTION
KY2-ALR (PROTECTED
EMERGENCY STOP (1NC) NO
CONTACTED ALARM BUTTON
COMBINATION
PACKAGE
10



CODE
010 104 000140
DESCRIPTION
PROTECTED EMER. STOP BUT.
(1NC)LAMP. CONTRACTOR
(1NO)24V CATA LED (1NO)
ALARM BUT. 16A COVER. SOC
PACKAGE
4



CODE
010 104 000141
DESCRIPTION
MS-KY3 PROTECTED
EMERGENCY STOP+ ALARM
BUTTON+16A COVERED
SOCKET COMBINATION
PACKAGE
5



CODE
010 104 000142
DESCRIPTION
MS-KY3ES012
PROTECTED EMER. STOP+
9VOLT BATTERY POWERED
130dB ALARM COMBINATION
PACKAGE
5



CODE
010 104 000143
DESCRIPTION
MS-KY4ES012 PROTECTED
EMERGENCY STOP+ 9VOLT
BATTERY POW. 130dB ALR.
AND 16A COV. SOC. COMB.
PACKAGE
4



CODE
010 091 020001
DESCRIPTION
MS-LV4 UP(1NO) DOWN(1-
NO) 0-1 REVISION (1NO)
EMERGENCY STOP (1NC)
(HAND CONTROL)
PACKAGE
6



CODE
010 104 000145
DESCRIPTION
MS-LV5P UP(1NO)COM. (1NO)
DOWN(1NO) 0-1 REVISION
(1NO) EMER. STOP (1NC) 16A
COVERED SOC. (HAND CON.)
PACKAGE
4



CODE
010 104 000146
DESCRIPTION
MS3BY-BG53P 3KD.BYPASS
LAMP BUTTON (1NO) 24V
CATA LED REG. ON (1NO) 16A
COVERED SOCKET COMB.
PACKAGE
4



CODE
010 104 000147
DESCRIPTION
MS9-BX07 UP(1NO) DOWN
(1NO) COMMON(1NO) 24V CATA
LED PROT. EMER. STOP (1NC)
ALARM(1NO) LAMP (1NO) PROT.
0-1 REV. (1NO) 16A
PACKAGE
1



CODE
010 104 000148
DESCRIPTION
MS102-ED21 3BY 3KD.BYP
REG.KEY(1NO) REG. ON (1NO)
24V CATA LED BREAK ON (1NO)
PROT. 0-1 SET RESET (1NO)
PACKAGE
4



CODE
010 104 000149
DESCRIPTION
MS201-ED21 REG.ON /
OFF(2NO) 24V CATA LED
LAMP BUTTON(1NO) BREAK
ON1(1NO) BREAK ON2 (1NO)
PROTECTED SET RESET(2NO)
PACKAGE
4



CODE
010 091 020028
DESCRIPTION
5 PIECE PROTECTED
REVISION BOX,1EMERGENCY
STOP BUTTON +2 PCS
ARROWED BUTTON +1
COMMON USED BUTTON +
1SELECTION BUTTON
PACKAGE
2



CODE
010 091 020029
DESCRIPTION
6 PIECE PROTECTED REV. BOX,
1EMERGENCY STOP BUT. +2
PCS ARROWED BUT.+1
COMMON USED BUT. +
1SELECTION BUT.+1 ALR. BUT.
PACKAGE
2

LIFT CONTROL BUTTON - DOUBLE CONTACT



CODE
010 104 000150
DESCRIPTION
MLK-2 Single Speed - 2
GANG Lift CONTROL -
Double CONTACT - 10A
PACKAGE
3



CODE
010 104 000151
DESCRIPTION
MLK-3 Single Speed - 3
GANG Lift CONTROL -
Double CONTACT - 10A
PACKAGE
3



CODE
010 104 000152
DESCRIPTION
MLK-4 Single Speed - 4
GANG Lift CONTROL -
Double CONTACT - 10A
PACKAGE
3



CODE
010 104 000153
DESCRIPTION
MLK-2M Single Speed -
2 GANG Lift CONTROL -
Magnet - 10A
PACKAGE
3



CODE
010 104 000154
DESCRIPTION
MLK-3M Single Speed -
2 GANG Lift CONTROL -
Magnet - 10A
PACKAGE
3



CODE
010 104 000155
DESCRIPTION
MLK-4M Single Speed -
4 GANG Lift CONTROL -
Magnet - 10A
PACKAGE
3

CRANE PUSH BUTTON



CODE
010 092 000001
DESCRIPTION
CRANE PUSH BUTTON 2
POSITION
PACKAGE
1



CODE
010 092 000003
DESCRIPTION
CRANE PUSH BUTTON 4
POSITION
PACKAGE
1



CODE
010 092 000005
DESCRIPTION
CRANE PUSH BUTTON 6
POSITION
PACKAGE
1



CODE
010 092 000002
DESCRIPTION
CRANE PUSH BUTTON 3
POSITION
PACKAGE
1



CODE
010 092 000004
DESCRIPTION
CRANE PUSH BUTTON 5
POSITION
PACKAGE
1



CODE
010 092 000006
DESCRIPTION
CRANE PUSH BUTTON 7
POSITION
PACKAGE
1

NEW

COMBINATION BOARDS



CODE
010 104 000180
DESCRIPTION
MK-325-2 3/25 A. 380V.
1 Pcs. Front - 1/16A.
220V. 2 Pcs. Side
PACKAGE
9



CODE
010 104 000181
DESCRIPTION
MK-516-1 5/16 A. 380V.
1 Pcs. Front - 1/16A.
220V. 1 Pcs. Side
PACKAGE
6



CODE
010 104 000182
DESCRIPTION
MK-516-2 5/16 A. 380V.
1 Pcs. Front - 1/16A.
220V. 2 Pcs. Side
PACKAGE
5



CODE
010 104 000183
DESCRIPTION
MK-532-1 5/32 A. 380V.
1 Pcs. Front - 1/16A.
220V. 1 Pcs. Side
PACKAGE
4



CODE
010 104 000184
DESCRIPTION
MK-532-2 5/32 A. 380V.
1 Pcs. Front - 1/16A.
220V. 2 Pcs. Side
PACKAGE
2



CODE
010 104 000185
DESCRIPTION
MK-2325-2 3/25 A.
380V. 2 Pcs. Front -
1/16A. 220V. 2 Pcs. Side
PACKAGE
10



CODE
010 104 000186
DESCRIPTION
MK-2516-2 5/16 A.
380V. 2 Pcs. Front -
1/16A. 220V. 2 Pcs. Side
PACKAGE
4



CODE
010 104 000187
DESCRIPTION
MK-2516-4 5/16 A.
380V. 2 Pcs. Front -
1/16A. 220V. 4 Pcs. Side
PACKAGE
5



CODE
010 104 000188
DESCRIPTION
MK-2532-2 5/32 A.
380V. 2 Pcs. Front -
1/16A. 220V. 2 Pcs. Side
PACKAGE
5



CODE
010 104 000189
DESCRIPTION
MK-2532-4 5/32 A.
380V. 2 Pcs. Front -
1/16A. 220V. 4 Pcs. Side
PACKAGE
4



CODE
010 104 000190
DESCRIPTION
MK-5164-4 5/16 A.
380V. 4 Pcs. Front -
1/16A. 220V. 4 Pcs. Side
PACKAGE
6



CODE
010 104 000191
DESCRIPTION
MK-5324-4 5/32 A.
380V. 4 Pcs. Front -
1/16A. 220V. 4 Pcs. Side
PACKAGE
4



CODE
010 104 000192
DESCRIPTION
MK-51632-4 5/16 A.
380V. 2 Pcs. Front+5/32
A. 380V. 2 Front -1/16A.
220V. 4 Pcs. Side
PACKAGE
2

COMBINATION BOXES



CODE
001 046 075130 00 17
DESCRIPTION
SOCKET DISTRIBUTION
BOX (EMPTY)(215X130)
PACKAGE
1/10



CODE
001 046 070220 00 17
DESCRIPTION
SOCKET DISTRIBUTION
BOX (EMPTY)(290X220)
PACKAGE
1/4

THERMOPLASTIC BOXES

 <p>PRODUCT COD 001 046 000101 00 00 DESCRIPTION SQUARE JUNCTION BOX 85X85 WHITE PACKAGE 10/108</p>	<p>IP65</p>  <p>PRODUCT COD 001 046 071827 00 17 DESCRIPTION THERMOPLASTIC BOX (180X 270X100) (14OUTLET) PACKAGE 2/8</p>	<p>IP65</p>  <p>PRODUCT COD 001 046 076131 00 17 DESCRIPTION THERMOPLASTIC BOX(138X226X131) PACKAGE 1/8</p>
<p>IP40</p>  <p>PRODUCT COD 001 046 078080 00 17 DESCRIPTION THERMOPLASTIC BOX (80X80X48)(7OUTLET) PACKAGE 18/108</p>	<p>IP65</p>  <p>PRODUCT COD 001 046 078226 00 17 DESCRIPTION SOCKET DISTRIBUTION BOX(138X226X127) PACKAGE 1/8</p>	<p>IP65</p>  <p>PRODUCT COD 001 046 072698 00 44 DESCRIPTION THERMOPLASTIC BOX (138X226X98)(14OUTLET) PACKAGE 1/8</p>
<p>IP40</p>  <p>PRODUCT COD 001 046 078585 00 17 DESCRIPTION THERMOPLASTIC BOX(85X85X48) PACKAGE 18/108</p>	<p>IP65</p>  <p>PRODUCT COD 001 046 075311 00 17 DESCRIPTION SOCKET DISTRIBUTION BOX (225X311X132) PACKAGE 1/4</p>	<p>IP65</p>  <p>PRODUCT COD 001 046 076131 00 44 DESCRIPTION THERMOPLASTIC BOX (138X226X131) PACKAGE 1/8</p>
<p>IP40</p>  <p>PRODUCT COD 001 046 070090 00 17 DESCRIPTION THERMOPLASTIC BOX(Ø90) PACKAGE 18/108</p>	<p>IP65</p>  <p>PRODUCT COD 001 046 071199 00 17 DESCRIPTION THERMOPLASTIC BOX(225X311X99) PACKAGE 1/4</p>	<p>IP65</p>  <p>PRODUCT COD 001 046 071199 00 44 DESCRIPTION THERMOPLASTIC BOX (225X311X99) PACKAGE 1/4</p>
<p>IP65</p>  <p>PRODUCT COD 001 046 071010 00 17 DESCRIPTION THERMOPLASTIC BOX (110X 110X74) (8 OUTLET) PACKAGE 10/40</p>	<p>IP65</p>  <p>PRODUCT COD 001 046 071130 00 17 DESCRIPTION THERMOPLASTIC BOX(225X311X130) PACKAGE 1/4</p>	<p>IP65</p>  <p>PRODUCT COD 001 046 071130 00 44 DESCRIPTION THERMOPLASTIC BOX (225X311X130) PACKAGE 1/4</p>
<p>IP65</p>  <p>PRODUCT COD 001 046 071118 00 17 DESCRIPTION THERMOPLASTICBOX (110X 180X77) (10OUTLET) PACKAGE 5/30</p>	<p>IP65</p>  <p>PRODUCT COD 001 046 072698 00 17 DESCRIPTION THERMOPLASTIC BOX(138X226X98) PACKAGE 1/8</p>	

THERMOPLASTIC BOXES (NON-FLAME)

IP40



PRODUCT COD
001 046 098080 00 17
DESCRIPTION
THERMOPLASTIC
BOX(NONFLAME)
(80X80X48)
PACKAGE
18/108

IP65



PRODUCT COD
001 046 098226 00 17
DESCRIPTION
SOCKET DISTRIBUTION
BOX(138X226X127)
(NOFLAME)
PACKAGE
1/8

IP65



PRODUCT COD
001 046 092698 00 44
DESCRIPTION
138X226X9(TRANSPAR-
ENT) THERMOPLASTIC
BOX (NON-FLAME)
PACKAGE
1/8

IP40



PRODUCT COD
001 046 098585 00 17
DESCRIPTION
THERMOPLASTIC
BOX(85X85X48) GRAY
PACKAGE
18/108

IP65



PRODUCT COD
001 046 095311 00 17
DESCRIPTION
SOCKET DISTRIBUTION
BOX (225X311X132)
PACKAGE
1/4

IP65



PRODUCT COD
001 046 096131 00 44
DESCRIPTION
138X226X131(TRANSPAR-
ENT)THERMOPLAS-
TIC BOX (NON-FLAME)
PACKAGE
1/8

IP40



PRODUCT COD
001 046 090090 00 17
DESCRIPTION
THERMOPLASTIC
BOX(NONFLAME)
(Ø90)
PACKAGE
18/108

IP65



PRODUCT COD
001 046 091199 00 17
DESCRIPTION
THERMOPLASTIC
BOX(225X311X99)
PACKAGE
1/4

IP65



PRODUCT COD
001 046 091199 00 44
DESCRIPTION
225X311X99(TRANSPAR-
ENT) THERMOPLASTIC
BOX (NON-FLAME)
PACKAGE
1/4

IP65



PRODUCT COD
001 046 091010 00 17
DESCRIPTION
THERMOPLASTIC
BOX(NONFLAME)
(110X110X74)
PACKAGE
10/40

IP65



PRODUCT COD
001 046 091130 00 17
DESCRIPTION
THERMOPLASTIC
BOX(225X311X130)
PACKAGE
1/4

IP65



PRODUCT COD
001 046 091130 00 44
DESCRIPTION
225X311X130 (TRAN.)
THERMOPLASTIC BOX
(NON-FLAME)
PACKAGE
1/4

IP65



PRODUCT COD
001 046 091118 00 17
DESCRIPTION
THERMOPLASTIC
BOX(NONFLAME)
(110X180X77)
PACKAGE
5/30

IP65



PRODUCT COD
001 046 092698 00 17
DESCRIPTION
THERMOPLASTIC
BOX(138X226X98)
PACKAGE
1/8

IP65



PRODUCT COD
001 046 091827 00 17
DESCRIPTION
THERMOPLASTIC
BOX(NONFLAME)
(180X270X100)
PACKAGE
2/8

IP65



PRODUCT COD
001 046 096131 00 17
DESCRIPTION
THERMOPLASTIC
BOX(138X226X131)
PACKAGE
1/8

INDUSTRIAL TYPE SOCKET - PLUG (MONOPHASE 1X16 A.)

CE  **CODE**
010 083 300027
DESCRIPTION
MUT-27 1X16 A. MONO.
EARTHED MALE SOCKET
PACKAGE
50/400

CE  **CODE**
010 083 300028
DESCRIPTION
MUT-28 1X16 A. MONO.
EARTHED MALE SOCKET
PACKAGE
50/400

CE  **CODE**
010 083 300029
DESCRIPTION
MUT-29 1X16 A. MONO.
EARTHED FEMALE SOCKET
PACKAGE
30/240

CE  **CODE**
010 083 500296
DESCRIPTION
MUT-296 1X16 A. MONO.
GROUNDED WALL SOCKET
PACKAGE
24/192

CE  **CODE**
010 083 500293
DESCRIPTION
MUT-29/3 1X16 A. MONO.
TRIPLE GROUP SOCKET
PACKAGE
12/96

CE  **CODE**
010 083 500294
DESCRIPTION
MUT-29/4 1X16 A. MONO.
FOUR GROUP SOCKET
PACKAGE
10/80

CE  **CODE**
010 083 501292
DESCRIPTION
MUT-292A 1X16 A. MONO.
2-GANG GROUP SOCKET
PACKAGE
12/96

CE  **CODE**
010 083 501293
DESCRIPTION
MUT-293A 1X16 A. MONO.
3-GANG GROUP SOCKET
PACKAGE
10/80

CE  **CODE**
010 083 500292
DESCRIPTION
MUT-29/2 1X16 A. MONO.
TOUBLE GROUP SOCKET
PACKAGE
12/96

INDUSTRIAL TYPE SOCKET - PLUG (TRIPHASE 3X25 A.)

 **CODE**
010 083 400030
DESCRIPTION
MUT-30 T-PHASE MALE
PLUG
PACKAGE
30/240

 **CODE**
010 083 400031
DESCRIPTION
MUT-31 3X25 A THREE
PHASE PORTABLE SOC.
PACKAGE
25/200

 **CODE**
010 083 600315
DESCRIPTION
MUT-315 3X25 A THREE
PHASE WALL SOCKET
PACKAGE
24/192

 **CODE**
010 083 600311
DESCRIPTION
MUT-311 1 THREE-
PHASE 1 MONOPHASE
PACKAGE
10/80

 **CODE**
010 083 600312
DESCRIPTION
MUT-312 THREE- PHASE
DOUBLE GRUP SOCKET
PACKAGE
10/80

 **CODE**
010 083 600313
DESCRIPTION
MUT-313 THREE-PHASE
TRIPLE GRUP SOCKET
PACKAGE
10/80

 **CODE**
010 083 600316
DESCRIPTION
MUT-316 2 THREE-PHASE
1 MONOPHASE
PACKAGE
10/80

 **CODE**
010 083 600317
DESCRIPTION
MUT-317 1 THREE-
PHASE 2 MONOPHASE
PACKAGE
10/80

INDUSTRIAL TYPE SOCKET - PLUG (TRIPHASE 3X16 A.)

CODE
010 083 400060
DESCRIPTION
MUT-60 3X16 THREE
PHASE MALE PLUG
PACKAGE
30/240



CODE
010 083 400061
DESCRIPTION
MUT-61 3X16 THREE
PHASE MOB. FEMALE PLUG
PACKAGE
25/200



CODE
010 083 400062
DESCRIPTION
MUT-62 3X16 THREE
PHASE WALL SOCKET
PACKAGE
20/160

INDUSTRIAL TYPE SOCKET - PLUG (TRIPHASE 3X32 A.)

CODE
010 083 400070
DESCRIPTION
MUT-70 3X32 THREE
PHASE MALE PLUG
PACKAGE
20/160



CODE
010 083 400071
DESCRIPTION
MUT-71 3X32 THREE
PHASE MOB. FEMALE PLUG
PACKAGE
15/120



CODE
010 083 400072
DESCRIPTION
MUT-72 3X32 THREE
PHASE WALL SOCKET
PACKAGE
20/160

INDUSTRIAL TYPE PLUG - SOCKET

CODE
010 083 000516
DESCRIPTION
MUT-101 5X16 A
FLAT PLUG
PACKAGE
16/128

CE



CODE
010 083 000532
DESCRIPTION
MUT-201 5X32 A
FLAT PLUG
PACKAGE
15/120

CE



CODE
010 083 010516
DESCRIPTION
MUT-102 5X16 A
EXTENSION PLUG
PACKAGE
15/120

CE



CODE
010 083 010532
DESCRIPTION
MUT-202 5X32 A
EXTENSION PLUG
PACKAGE
14/112

CE



CODE
010 083 020516
DESCRIPTION
MUT-103 5X16 A
MACHINE SOCKET
PACKAGE
20/160

CE



CODE
010 083 020532
DESCRIPTION
MUT-203 5X32 A
MACHINE SOCKET
PACKAGE
14/112

CE



CODE
010 083 030516
DESCRIPTION
MUT-104 5X16 A
WALL PLUG CEE
PACKAGE
8/64

CE



CODE
010 083 030532
DESCRIPTION
MUT-204 5X32 A
WALL PLUG CEE
PACKAGE
8/64

CE

INDUSTRIAL TYPE SOCKET - PLUG (MONOPHASE 1X16 A.)



CODE
010 083 500298
DESCRIPTION
MUT-298 MONOPHASE
GROUNDED PANEL SOC
PACKAGE
40/320



CODE
010 083 501297
DESCRIPTION
MUT-298-U MONO. UPS
GROUNDED PANEL SOC
PACKAGE
30/240



CODE
010 083 500297
DESCRIPTION
MUT-297 MONO. WALL
SOCKET (PLASTIC)
PACKAGE
30/240

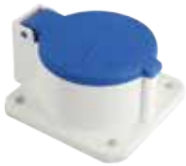

CODE
010 083 500299
DESCRIPTION
MUT-297 MONO.
MACHINE SOCKET
PACKAGE
20/160



CODE
010 083 502910
DESCRIPTION
MUT-2910 MONO.
WALL SOCKET
PACKAGE
15/120

INDUSTRIAL TYPE SOCKET - PLUG (TRIPHASE 3X16 A.)



CODE
010 083 400064
DESCRIPTION
MUT-64 3X16 THREE
PHASE MACHINE SOC.
PACKAGE
20/160



CODE
010 083 400063
DESCRIPTION
MUT-62 3X16 THREE
PHASE WALL SOCKET
PACKAGE
12/96

INDUSTRIAL TYPE SOCKET - PLUG (TRIPHASE 3X25 A.)



CODE
010 083 400318
DESCRIPTION
MUT-318 3X25 THREE
PHASE MACHINE SOC.
PACKAGE
20/160



CODE
010 083 400319
DESCRIPTION
MUT-319 3X25 THREE
PHASE WALL SOCKET
PACKAGE
15/120

INDUSTRIAL TYPE SOCKET - PLUG (TRIPHASE 3X32 A.)



CODE
010 083 400074
DESCRIPTION
MUT-74 3X32 THREE
PHASE MACHINE SOC.
PACKAGE
20/160



CODE
010 083 400073
DESCRIPTION
MUT-73 3X32 THREE
PHASE WALL SOCKET
PACKAGE
12/96

Code	Product Description	Number of Box	Quantity of Pack
SİNTAŞ INDUSTRIAL TYPE PLUG SOCKETS			
019 107 016250	16X25 A.4 POLAR PLUG-SOCKET	1 pcs.	30
019 107 016252	16X25 A.4 POLAR SOCKET	1 pcs.	45
019 107 016251	16X25 A.4 POLAR PLUG	1 pcs.	60
019 107 025400	25X40 A.4 POLAR PLUG-SOCKET	1 pcs.	15
019 107 025402	25X40 A.4 POLAR SOCKET	1 pcs.	25
019 107 025401	25X40 A.4 POLAR PLUG	1 pcs.	35
019 107 040630	40X63 A.4 POLAR PLUG-SOCKET	1 pcs.	10
019 107 040632	40X63 A.4 POLAR SOCKET	1 pcs.	15
019 107 040631	40X63 A.4 POLAR PLUG	1 pcs.	25
019 107 063100	63X100 A.4 POLAR PLUG-SOCKET	1 pcs.	5
019 107 063102	63X100 A.4 POLAR SOCKET	1 pcs.	10
019 107 063101	63X100 A.4 POLAR PLUG	1 pcs.	15
SİNTAŞ INDUSTRIAL TYPE PORTABLE SOCKETS			
019 107 016253	16X25 A.4 POLAR PORTABLE SOCKET	1 pcs.	45
019 107 025403	25X40 A.4 POLAR PORTABLE SOCKET	1 pcs.	25
019 107 040633	40X63 A.4 POLAR PORTABLE SOCKET	1 pcs.	15
019 107 063103	63X100 A.4 POLAR PORTABLE SOCKET	1 pcs.	10
POWER POWER SWITCHES			
041 118 000201	MONOPHASE POWER SWITCH	1 pcs.	100
041 118 000200	THREE-PHASE POWER SWITCH	1 pcs.	50
EXTENSION LIGHT			
005 084 700016	EXTENSION LIGHT CORDS WITH REFLECTOR	1 pcs.	25
005 084 700017	EXTENSION LIGHT CORDS WITH REFLECTOR AND SWITCH	1 pcs.	25
EXTENSION LIGHT (WIRE CAGE)			
005 084 700003	PLASTIC SHANK(LAMPHOLDERLESS-WITHOUT SWITCH)	1 pcs.	25
005 084 700009	PLASTIC SHANK(WITH LAMPHOLDER-WITHOUT SWITCH)	1 pcs.	25
005 084 700004	PLASTIC SHANK(CERAMIC WITH LAMP.-WITH SWITCH)	1 pcs.	25
005 084 700006	PLASTIC SHANK(CERAMIC WITH LAMP.-WITH SWITCH)	1 pcs.	15
005 084 700007	PLASTIC SHANK(CERAMIC WITH LAMP-WITH SWITCH)	1 pcs.	12
005 084 700010	PLASTIC SHANK(CERAMIC WITH LAMP-WITH SWITCH)	1 pcs.	10
005 084 700011	PLASTIC SHANK(CERAMIC WITH LAMP-WITH SWITCH)	1 pcs.	8
005 084 700012	PLASTIC SHANK(CERAMIC WITH LAMP-WITH SWITCH)	1 pcs.	8
CABLE REELS (PLASTIC BODY)			
005 083 700045	CODE-45 SINGLE-PHASE PLASTIC EMPTY SPOOL	1 pcs.	
005 083 700120	MONOFAZE PLASTIC REEL 20MT 3X1,5 WIRED (4 MONOFAZE SOCKET)	1 pcs.	
005 083 700130	MONOFAZE PLASTIC REEL 30MT 3X1,5 WIRED (4 MONOFAZE SOCKET)	1 pcs.	
005 083 700140	MONOFAZE PLASTIC REEL 40MT 3X1,5 WIRED (4 MONOFAZE SOCKET)	1 pcs.	
005 083 700150	MONOFAZE PLASTIC REEL 50MT 3X1,5 WIRED (4 MONOFAZE SOCKET)	1 pcs.	
005 083 700046	CODE-46 THREE-PHASE PLASTIC EMPTY SPOOL	1 pcs.	
EXTENSION CABLES WITH PRINTED PLUGS			
005 083 700005	EXT. CAB. WITH 2 END (MALE-FEMALE) PRINTED PLUG 5MT 3X1	1 pcs.	
005 083 700010	EXT. CAB. WITH 2 END (MALE-FEMALE) PRINTED PLUG 10MT 3X1	1 pcs.	
005 083 700015	EXT. CAB. WITH 2 END (MALE-FEMALE) PRINTED PLUG 15MT 3X1	1 pcs.	
005 083 700020	EXT. CAB. WITH 2 END (MALE-FEMALE) PRINTED PLUG 20MT 3X1	1 pcs.	
005 083 700025	EXT. CAB. WITH 2 END (MALE-FEMALE) PRINTED PLUG 25MT 3X1	1 pcs.	



RGB SERIES



PRO SERIES 1 COLOR RGB METAL WARNING LIGHTS

Ø50	Part No.	Model	Features	Voltage	Qty.
	129 087 000606	PRO-X324	CONTINUOUS	24 VDC	1 qty.
	129 087 000607	PRO-X324B	CONTINUOUS+BUZZER	24 VDC	1 qty.

T6 SERIES Q60 RGB WARNING LIGHTS

	129 087 000671	M-T6-243	MULTI	24V DC	1 qty.
	129 087 000672	M-T6-223	MULTI	220V AC	1 qty.
	129 087 000673	MB-T6-243	MULTI+BUZZER	24V DC	1 qty.
	129 087 000674	MB-T6-223	MULTI+BUZZER	220V AC	1 qty.

R6 SERIES RGB WARNING LIGHTS

	129 087 000675	M-R6-243	MULTI	24V DC	1 qty.
	129 087 000676	M-R6-223	MULTI	220V AC	1 qty.
	129 087 000677	MB-R6-243	MULTI+BUZZER	24V DC	1 qty.
	129 087 000678	MB-R6-223	MULTI+BUZZER	220V AC	1 qty.

T7K SERIES RGB WARNING LIGHTS

	129 087 000679	M-T7K-243	MULTI	24V DC	1 qty.
	129 087 000680	M-T7K-223	MULTI	220V AC	1 qty.
	129 087 000681	MB-T7K-243	MULTI+BUZZER	24V DC	1 qty.
	129 087 000682	MB-T7K-223	MULTI+BUZZER	220V AC	1 qty.

R7K SERIES RGB WARNING LIGHTS

	129 087 000683	M-R7K-243	MULTI	24V DC	1 qty.
	129 087 000684	M-R7K-223	MULTI	220V AC	1 qty.
	129 087 000685	MB-R7K-243	MULTI+BUZZER	24V DC	1 qty.
	129 087 000686	MB-R7K-223	MULTI+BUZZER	220V AC	1 qty.

V7K SERIES RGB WARNING LIGHTS

Ø70	Part No.	Model	Features	Voltage	Qty.
	129 087 000687	M-V7K-243	MULTI	24V DC	1 qty.
	129 087 000688	M-V7K-223	MULTI	220V AC	1 qty.
	129 087 000689	MB-V7K-243	MULTI+BUZZER	24V DC	1 qty.
	129 087 000690	MB-V7K-223	MULTI+BUZZER	220V AC	1 qty.

QH SERIES RGB WARNING LIGHTS

	129 087 000691	M-QH-X324	MULTI	24V DC	1 qty.
	129 087 000692	M-QH-X322	MULTI	220V AC	1 qty.
	129 087 000693	MB-QH-X324	MULTI+BUZZER	24V DC	1 qty.
	129 087 000694	MB-QH-X322	MULTI+BUZZER	220V AC	1 qty.

BH SERIES RGB WARNING LIGHTS

	129 087 000695	M-BH-X324	MULTI	24V DC	1 qty.
	129 087 000696	M-BH-X322	MULTI	220V AC	1 qty.
	129 087 000697	MB-BH-X324	MULTI+BUZZER	24V DC	1 qty.
	129 087 000698	MB-BH-X322	MULTI+BUZZER	220V AC	1 qty.

BH SERIES MULTI 105dB LED HORNS

	129 087 000401	MB-BH-24X	MULTI	24V DC	1 qty.
	129 087 000403	MB-BH-220X	MULTI	220V AC	1 qty.
	129 087 000405	MB-BH-242	MULTI	24V DC	1 qty.
	129 087 000407	MB-BH-2202	MULTI	220V AC	1 qty.
	129 087 000409	MB-BH-243	MULTI	24V DC	1 qty.
	129 087 000411	MB-BH-2203	MULTI	220V AC	1 qty.

QH SERIES MULTI 105dB LED HORNS

	129 087 000400	MB-QH-24X	MULTI	24V DC	1 qty.
	129 087 000402	MB-QH-220X	MULTI	220V AC	1 qty.
	129 087 000404	MB-QH-242	MULTI	24V DC	1 qty.
	129 087 000406	MB-QH-2202	MULTI	220V AC	1 qty.
	129 087 000408	MB-QH-243	MULTI	24V DC	1 qty.
	129 087 000410	MB-QH-2203	MULTI	220V AC	1 qty.

B-B SERIES Q 67 LED HORNS (CONTINUOUS/FLASHING)

	129 087 000230	B-B-24	95dB/30cm	24V	1 qty.
	129 087 000233	B-B-220	95dB/30cm	220V	1 qty.
	129 087 000631	B-BH-24	115dB/30cm	24V	1 qty.
	129 087 000632	B-BH-220	115dB/30cm	220V	1 qty.

B-Q SERIES Q 67 LED HORNS (CONTINUOUS/FLASHING)

	129 087 000235	B-Q-24	95dB/30cm	24V	1 qty.
	129 087 000238	B-Q-220	95dB/30cm	220V	1 qty.
	129 087 000633	B-QH-24	115dB/30cm	24V	1 qty.
	129 087 000634	B-QH-220	115dB/30cm	220V	1 qty.

FM SERIES BUZZER (CONTINUOUS/FLASHING)

	129 087 000245	FM-12A-905AL70	90dB/30cm	12V	1 qty.
	129 087 000246	FM-12Q-905L70	95dB/60cm	12V	1 qty.
	129 087 000247	FM-24C-905L70	92dB/100cm	24V	1 qty.
	129 087 000248	FM-220A-905AL70	95dB/30cm	220V	1 qty.
	129 087 000249	FM-24C-900L700	92dB/100cm	24V	1 qty.
	129 087 000250	FM-220A-905A	90dB/300cm	220V	1 qty.
	129 087 000251	FM-12A-905A	90dB/30cm	12V	1 qty.
	129 087 000252	FM-12Q-905	90dB/30cm	12V	1 qty.



Cod	Explanation	Working Method	Supply Voltage	Package
-----	-------------	----------------	----------------	---------

PRO SERIES 1 COLOR MODULER TOWER LIGHTS

129 087 000608	PRO-241	CONTINUOUS	24 VDC	1 qty.
129 087 000609	PRO-241B	CONTINUOUS+BUZZER	24 VDC	1 qty.

PRO SERIES 2 COLOR MODULER TOWER LIGHTS

129 087 000610	PRO-242	CONTINUOUS	24 VDC	1 qty.
129 087 000611	PRO-242B	CONTINUOUS+BUZZER	24 VDC	1 qty.

PRO SERIES 3 COLOR MODULER TOWER LIGHTS

129 087 000612	PRO-243	CONTINUOUS	24 VDC	1 qty.
129 087 000613	PRO-243B	CONTINUOUS+BUZZER	24 VDC	1 qty.

PRO SERIES 4 COLOR MODULER TOWER LIGHTS

129 087 000614	PRO-244	CONTINUOUS	24 VDC	1 qty.
129 087 000615	PRO-244B	CONTINUOUS+BUZZER	24 VDC	1 qty.

PRO SERIES 5 COLOR MODULER TOWER LIGHTS

129 087 000616	PRO-245	CONTINUOUS	24 VDC	1 qty.
129 087 000617	PRO-245B	CONTINUOUS+BUZZER	24 VDC	1 qty.

T5 1 COLOR MODULER TOWER LIGHTS

129 087 000278	S-T5-241	CONTINUOUS	24V DC	1 qty.
129 087 000279	S-T5-2201	CONTINUOUS	220V AC	1 qty.
129 087 000281	F-T5-241	FLASHING	24V DC	1 qty.
129 087 000282	F-T5-2201	FLASHING	220V AC	1 qty.
129 087 000284	Ç-T5-241	STROBE	24V DC	1 qty.
129 087 000285	Ç-T5-2201	STROBE	220V AC	1 qty.
129 087 000287	SB-T5-241	CONTINUOUS+BUZZER	24V DC	1 qty.
129 087 000288	SB-T5-2201	CONTINUOUS+BUZZER	220V AC	1 qty.
129 087 000290	FB-T5-241	FLASHING+BUZZER	24V DC	1 qty.
129 087 000291	FB-T5-2201	FLASHING+BUZZER	220V AC	1 qty.
129 087 000293	ÇB-T5-241	STROBE+BUZZER	24V DC	1 qty.
129 087 000294	ÇB-T5-2201	STROBE+BUZZER	220V AC	1 qty.

T5 2 COLOR MODULER TOWER LIGHTS

129 087 000296	S-T5-242	CONTINUOUS	24V DC	1 qty.
129 087 000297	S-T5-2202	CONTINUOUS	220V AC	1 qty.
129 087 000299	F-T5-242	FLASHING	24V DC	1 qty.
129 087 000300	F-T5-2202	FLASHING	220V AC	1 qty.
129 087 000302	SB-T5-242	CONTINUOUS+BUZZER	24V DC	1 qty.
129 087 000303	SB-T5-2202	CONTINUOUS+BUZZER	220V AC	1 qty.
129 087 000305	FB-T5-242	FLASHING+BUZZER	24V DC	1 qty.
129 087 000306	FB-T5-2202	FLASHING+BUZZER	220V AC	1 qty.

T5 3 COLOR MODULER TOWER LIGHTS

129 087 000308	S-T5-243	CONTINUOUS	24V DC	1 qty.
129 087 000309	S-T5-2203	CONTINUOUS	220V AC	1 qty.
129 087 000311	F-T5-243	FLASHING	24V DC	1 qty.
129 087 000312	F-T5-2203	FLASHING	220V AC	1 qty.
129 087 000314	SB-T5-243	CONTINUOUS+BUZZER	24V DC	1 qty.
129 087 000315	SB-T5-2203	CONTINUOUS+BUZZER	220V AC	1 qty.
129 087 000317	FB-T5-243	FLASHING+BUZZER	24V DC	1 qty.
129 087 000318	FB-T5-2203	FLASHING+BUZZER	220V AC	1 qty.

T7 1 COLOR MODULER TOWER LIGHTS

129 087 000651	M-T7-241	MULTI	24V DC	1 qty.
129 087 000652	M-T7-221	MULTI	220V AC	1 qty.
129 087 000653	MB-T7-241	MULTI+BUZZER	24V DC	1 qty.
129 087 000654	MB-T7-221	MULTI+BUZZER	220V AC	1 qty.

T7 2 COLOR MODULER TOWER LIGHTS

129 087 000655	M-T7-242	MULTI	24V DC	1 qty.
129 087 000656	M-T7-222	MULTI	220V AC	1 qty.
129 087 000657	MB-T7-242	MULTI+BUZZER	24V DC	1 qty.
129 087 000658	MB-T7-222	MULTI+BUZZER	220V AC	1 qty.

T7 3 COLOR MODULER TOWER LIGHTS

129 087 000659	M-T7-243	MULTI	24V DC	1 qty.
129 087 000660	M-T7-223	MULTI	220V AC	1 qty.
129 087 000661	MB-T7-243	MULTI+BUZZER	24V DC	1 qty.
129 087 000662	MB-T7-223	MULTI+BUZZER	220V AC	1 qty.

T7 4 COLOR MODULER TOWER LIGHTS

129 087 000663	M-T7-244	MULTI	24V DC	1 qty.
129 087 000664	M-T7-224	MULTI	220V AC	1 qty.
129 087 000665	MB-T7-244	MULTI+BUZZER	24V DC	1 qty.
129 087 000666	MB-T7-224	MULTI+BUZZER	220V AC	1 qty.

T7 5 COLOR MODULER TOWER LIGHTS

129 087 000667	M-T7-245	MULTI	24V DC	1 qty.
129 087 000668	M-T7-225	MULTI	220V AC	1 qty.
129 087 000669	MB-T7-245	MULTI+BUZZER	24V DC	1 qty.
129 087 000670	MB-T7-225	MULTI+BUZZER	220V AC	1 qty.



In lighted columns, red is fixed color. Other colors are made to order and are non-refundable.



T6



R6



F7



T7K



T8



V8



VT8



T9 ÖZEL



T9



T10



T12



HD-22K



HD-22B1



HD-22B



HD-22B1K



HD-22BK

Diameter	Cod	Explanation	Working Method	Supply Voltage	Package
Ø60	T6 SERIES MULTI FUNCTION Q60 WARNING LIGHTS				
	129 087 000441	M-T6-24K	MULTI	24V DC	1 qty.
	129 087 000442	M-T6-22K	MULTI	220V AC	1 qty.
	129 087 000443	MB-T6-24K	MULTI+BUZZER	24V DC	1 qty.
	129 087 000444	MB-T6-22K	MULTI+BUZZER	220V AC	1 qty.
	R6 SERIES MULTI FUNCTION Q60 WARNING LIGHTS				
	129 087 000635	M-R6-24K	MULTI	24V DC	1 qty.
	129 087 000636	M-R6-22K	MULTI	220V AC	1 qty.
	129 087 000637	MB-R6-24K	MULTI+BUZZER	24V DC	1 qty.
	129 087 000638	MB-R6-22K	MULTI+BUZZER	220V AC	1 qty.
Ø70	F7 SERIES 12... 80 V/DC WARNING LIGHTS				
	129 087 000622	M-F7-24	MULTI	24 VDC	1 qty.
	129 087 000623	M-F7-22	MULTI	220 VAC	1 qty.
	129 087 000624	MB-F7-24	MULTI+BUZZER	24 VDC	1 qty.
	129 087 000625	MB-F7-22	MULTI+BUZZER	220 VAC	1 qty.
Ø70	T7K SERIES MULTI FUNCTION WARNING LIGHTS				
	129 087 000639	M-T7K-24	MULTI	24V DC	1 qty.
	129 087 000640	M-T7K-22	MULTI	220V AC	1 qty.
	129 087 000641	MB-T7K-24	MULTI+BUZZER	24V DC	1 qty.
	129 087 000642	MB-T7K-22	MULTI+BUZZER	220V AC	1 qty.
Ø80	V8 SERIES MULTI FUNCTION Q84 WARNING LIGHTS				
	129 087 000445	M-V8-24K	MULTI	24V DC	1 qty.
	129 087 000446	M-V8-22K	MULTI	220V AC	1 qty.
	129 087 000447	MB-V8-24K	MULTI+BUZZER	24V DC	1 qty.
	129 087 000448	MB-V8-22K	MULTI+BUZZER	220V AC	1 qty.
Ø80	T8 SERIES MULTI FUNCTION WARNING LIGHTS				
	129 087 000449	M-T8-24K	MULTI	24V DC	1 qty.
	129 087 000450	M-T8-22K	MULTI	220V AC	1 qty.
	129 087 000451	MB-T8-24K	MULTI+BUZZER	24V DC	1 qty.
	129 087 000452	MB-T8-22K	MULTI+BUZZER	220V AC	1 qty.
Ø80	VT8 SERIES MULTI FUNCTION Q84 WARNING LIGHTS				
	129 087 000453	M-VT8-24K	MULTI	24V DC	1 qty.
	129 087 000454	M-VT8-22K	MULTI	220V AC	1 qty.
	129 087 000455	MB-VT8-24K	MULTI+BUZZER	24V DC	1 qty.
	129 087 000456	MB-VT8-22K	MULTI+BUZZER	220V AC	1 qty.
Ø90	T9 SERIES MULTI FUNCTION WARNING LIGHTS				
	129 087 000457	M-T9-24K	MULTI	24V DC	1 qty.
	129 087 000458	M-T9-22K	MULTI	220V AC	1 qty.
	129 087 000459	MB-T9-24K	MULTI+BUZZER	24V DC	1 qty.
	129 087 000460	MB-T9-22K	MULTI+BUZZER	220V AC	1 qty.
Ø90	T10 SERIES MULTI FUNCTION WARNING LIGHTS				
	007 087 400105	JM-MM9-12	MULTI + USB CHARGED	12 V	1 qty.
	007 087 400109	PM-MM9-12	MULTI + BATTERY OPERATED	12 V	1 qty.
Ø100	T10 SERIES MULTI FUNCTION WARNING LIGHTS				
	129 087 000643	M-T10-24K	MULTI	24 VDC	1 qty.
	129 087 000644	M-T10-22K	MULTI	220 VAC	1 qty.
	129 087 000645	MB-T10-24K	MULTI+BUZZER	24 VDC	1 qty.
	129 087 000646	MB-T10-22K	MULTI+BUZZER	220 VAC	1 qty.
Ø120	T12 SERIES MULTI FUNCTION WARNING LIGHTS				
	129 087 000647	M-T12-24K	MULTI	24 VDC	1 qty.
	129 087 000648	M-T12-22K	MULTI	220 VAC	1 qty.
	129 087 000649	MB-T12-24K	MULTI+BUZZER	24 VDC	1 qty.
	129 087 000650	MB-T12-22K	MULTI+BUZZER	220 VAC	1 qty.

HEAVY DUTY SERIES WARNING LIGHTS

129 087 000619	HD-22K	MULTI	12-24 VDC / 220 VAC	1 qty.
129 087 000618	HD-22B	7 DIFFERENT SOUNDS	12-24 VDC / 220 VAC	1 qty.
129 087 000620	HD-22BK	7 DIFFERENT SOUNDS	12-24 VDC / 220 VAC	1 qty.
129 087 000700	HD-22B1	MULTI + 7 DIFFERENT SOU.	12-24 VDC / 220 VAC	1 qty.
129 087 000701	HD-22B1K	MULTI + 7 DIFFERENT SOU.	12-24 VDC / 220 VAC	1 qty.