

BRISK®



GARDEN



2014

CATALOGUE / KATALOG / КАТАЛОГ



GARDEN

CONTENTS *OBSAH* *СОДЕРЖАНИЕ*



2



15

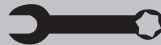

SERVICE INSTRUCTIONS

79



CROSS REFERENCE

85



LAST INFO

134

SINCE 1935

BRITA



JYSKRA
N.P. TÁBOR

BRISK



Quality Management System
ISO/TS 16949



Environmental Management System
ISO 14001:2004



Zapalovací svíčky BRISK pro motorové pily a motory malé zemědělské mechanizace

Zapalovací svíčky označené počátečními písmeny P, U, J, K, S, T v systému značení BRISK jsou speciálně konstruované pro použití v motorových pilách, motorech křovinořezů, travních sekaček a stacionárních pohonných jednotek.

Vyznačují se spolehlivou funkcí jak při volnoběhu, tak i při maximálním výkonu, což je charakteristický druh provozu pro motorové pily. Nezanášejí se úsadami hoření a nezpůsobují samozápaly a následně vylétání žhavých jisker z výfuku. Speciální konstrukce zajišťuje nízkou váhu a odolnost proti vibracím.

BRISK spark plugs for power saws and motor of small agricultural machines

Spark plugs identified with initial letters P, U, J, K, S, T in the Brisk marking system are specially designed for applications in chain saws, brush cutters, lawnmowers and stationary drive units.

They provide reliable function at idle speed as well as at maximum output, which is a characteristic operating mode chain saws. They do not get logged with combustion-related deposits and do not cause self-ignition and subsequent release of hot sparks from the exhaust pipe. Thanks to their special design, they have a low and are resistant to vibrations.

Свечи зажигания «BRISK» для бензопил и двигателей мелкой сельхозтехники

Свечи зажигания «BRISK» обозначение буквами P, U, J, K, S, T - это изделия специально созданные для двигателей бензопил, кусторезов, сенокосилок и т.п.

Отличаются надежностью как на стадии холостого хода, так и при максимальной нагрузке, что прежде всего требуется для бензопил. Свечи не загрязняются нагаром, препятствуют самовоспламенению горючего и искробразованию выхлодов. Специальными мероприятиями достигнуто масляного веса и вибростойкости.

- spolehlivost, kvalita
- kompletní sortiment
- profi využití

- reliability, duality
- full range
- professional applications

- надежность, качество
- полный ассортимент
- профессиональное применение

Jsou vyráběny ve výrobním procesu, který je certifikován v systému jakostí podle mezinárodní normy ISO/TS 16949. Výroba probíhá s použitím kvalitních materiálů a komponentů nakupovaných globálně od auditovaných a pravidelně hodnocených dodavatelů.

Provozní vlastnosti zapalovacích svíček Brisk P, U, J, K, S, T se osvědčily jak v podmínkách „hobby“, tak i „profesionál“. Svíčky jsou odzkoušeny při všech běžných pracovních úkonech s malou zemědělskou mechanizací v terénu.

The quality system of their manufacturing process has been certified according to international standard ISO/TS 16949. High-quality materials and components purchased globally from audited and regularly evaluated suppliers are used in production.

Operating features of Brisk spark plugs P, U, J, K, S, T have been proven in both HOBBY and PROFESSIONAL conditions. The spark plugs have been tested in Terezin for all common operations with small agricultural machines.

Изготовление свечей сертифицировано в соответствии с международной системой ISO/TS 16949 и ISO 14001. Для производства применяются только компоненты и материалы высокого качества, приобретенные у поставщиков успешно прошедших сертификацию и аудит.

Высокое качество свечей зажигания «BRISK» P, U, J, K, S, T подтвердилось при их эксплуатации как в условиях «профессионал», так и в условиях «хобби». Свечи прошли успешно испытаниями во всех режимах встречающихся на практике.



Konstrukce zapalovací svíčky

- 1 - kabelová matice ISO
- 2 - svorník s úpravou pro zvýšení odolnosti proti vibracím
- 3 - izolátor
- 4 - zátav
- 5 - pouzdro
- 6 - těsnící podložka (typ "U" - těsnění kuzelem)
- 7 - vyrovnávací kroužek
- 8 - střední elektroda
- 9 - vnější elektroda

Spark plug design

- 1 - ISO cable nut
- 2 - Pin (vibration resistant design)
- 3 - Insulator
- 4 - Layer sealing
- 5 - Metal shell
- 6 - Sealing washer (type "U" sealing cone)
- 7 - Compensating ring
- 8 - Centre electrode
- 9 - Ground electrode

Состав свечи зажигания

- 1 - контактная гайка ИСО
- 2 - контактная головка (с повышенной вибростойкостью)
- 3 - изолятор
- 4 - резистор - трехслойный герметик
- 5 - корпус
- 6 - шайба теплоотводящая (типа «U» уплотняющий конус)
- 7 - уплотнительное кольцо
- 8 - центральный электрод
- 9 - боковой электрод

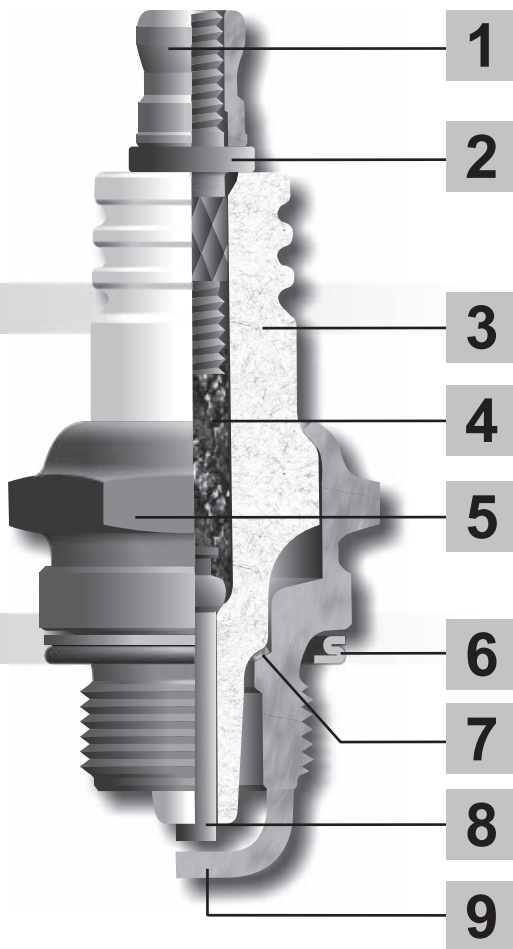

Technické požadavky na zapalovací svíčky

Rozměry – odpovídají mezinárodním rozměrovým normám

Technical requirements for the spark plugs

Dimensions – comply with international dimensional standards

Технические требования к свечам зажигания

Габариты соответствуют международным стандартам

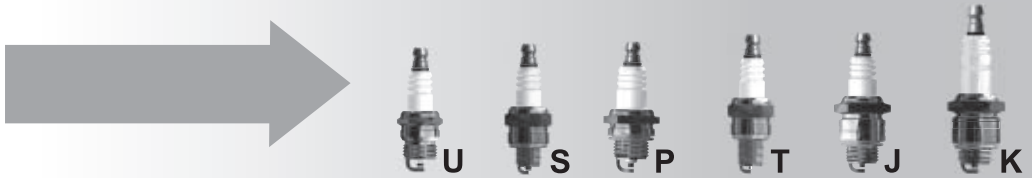

Oduřovací schopnost

Využívání motorových pil, travních sekaček a jiné malé mechanizace v hustší městské zástavbě vyvolalo nutnost zamezit rušivému vyzařování elektromagnetických vln těchto zařízení.

Plnění přísných legislativních předpisů je řešeno použitím oduřených zapalovacích svíček s ohmickou hodnotou 10 k Ω .

Interference suppresion feature

The use of chain saws, lawnmowers and other small machines in high-density urban development has led to the need of suppresion of radiation of electromagnetic waves of these devices.

The most stringent regulatory requirements are met by the use of RFI-suppressed spark plugs with resistance value of 10 k Ω .

Способность сопротивлять помехам

Использование бензопил, сенокосилок и дпругой механизации в населенных пунктах вызвало жесткое требование устранить возникающие при их эксплуатации электромагнитное излучение.

Решением является применение свечей зажигания с резистором с омическим сопортивлением 10 k Ω .

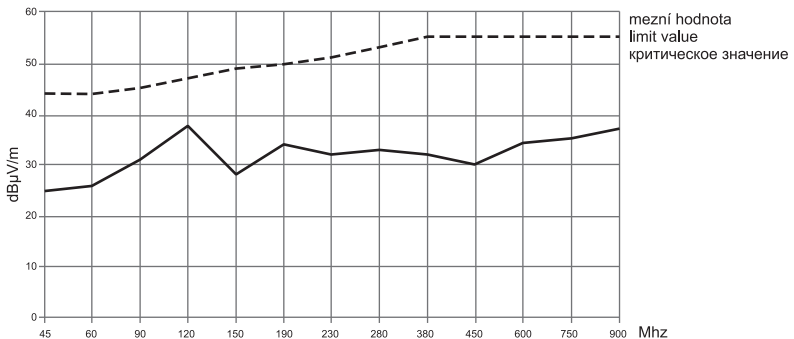

Odolnost proti vibracím

Provoz maloobjemových jak dvoutaktních, tak i čtyřtaktních motorů v různých aplikacích vyžaduje vysokou odolnost zapalovacích svíček proti vibračnímu namáhání.

Řešeno:

- krátkou délkou zapal.svíček
- konstrukční úpravy (ukotvení svorníku v izolátoru)
- mechanickým zajištěním kabelové matice ISO (nebo integrovaný svorník)

Vibration resistance

Operation of small-capacity both two-stroke and four-stroke engines in various applications requires high vibration resistance of the spark plugs.

This is solved by:

- short length of the spark plugs
- spark plug design (anchoring of the pin in the insulator)
- mechanical fixation of ISO cable nut (nebo integrovaný svorník)

Вибрационная стойкость

Эксплуатация двигателей малого объема создает необходимость защищать свечи зажигания от вибрационных нагрузок.

Решение:

- малая длина свечи
- конструктивные мероприятия (соединение контактной головки в изоляторе)
- укрепление контактной гайки

Životnost

Zabezpečení bezvadné funkce ve všech provozních režimech, plnění přísných emisních limitů a spolehlivé starty zajišťují zapalovací svíčky BRISK řady GARDEN svou širokozahovostí.

Systematickou kontrolou tepelné hodnoty zapalovacích

svíček na speciálním zařízení (měrném motoru), dlouhodobými zkouškami ve zkušebně BRISKu i u odběratelů a zejména správnou volbou, tj. přiřazením typu zapal.svíčky k danému motoru je dosahováno životnosti požadované výrobcí motorů a jejich uživatelů (300 hod.).

Service life

Thanks to its wide range the BRISK spark plugs of GARDEN line provide perfect function in all operating modes, fulfilment of the most stringent emission limits and reliable starting.

Long service life (300 hours) as required by the manufactures and users of engines is reached thanks to

the systematic check of the spark plug heat range on a special equipment (measuring motor), long-run tests in both BRISK testing laboratory and at the clients, and above all by correct selection i.e. assignment of the spark plug type to a specific motor.

Долговечность

Проверкой калильного числа на специальном стенде, продолжительными испытаниями в лаборатории фирмы «BRISK» и у покупателей а прежде всего правильным

подбором свечи для конкретного двигателя достигается срока службы, который требуют изготовители двигателей и потребители (300 часов)

Technologie výroby zapalovací svíčky

Přesto, že se zapalovací svíčka skládá pouze se sedmi až devíti základních částí, je sériová výroba velmi náročná a vyžaduje speciální technologické zařízení vyvinuté předními světovými firmami.

Pro výrobu zapalovacích svíček používá BRISK Tábor a.s. nejvyšší kvalitu materiálů dodávané specializovanými firmami.

Použití nejvyšších materiálů, vyspělé technologie výroby, certifikace systému řízení jakosti podle norem ISO/TS 16949, ISO 14001 a vlastní vývojové centrum s vybavenými laboratořemi a zkušebnami – to jsou základy pro produkci zapalovacích svíček, splňující nejvyšší požadavky výrobců motorů.

Spark plug manufacturing technology

Although the spark plug consists only seven to nine basic parts, its series production is complex and requires special manufacturing equipment developed by leading world companies.

BRISK uses high quality materials supplied by specialized firms for the spark plug production.

The use of high quality materials, advanced technologies, quality system certified according to ISO/TS 16949, ISO 14001 and own development centre with laboratories and test rooms – these are the bases for spark plug production meeting the most demanding requirements of engine manufacturers.

Технология изготовления свечей

Не смотря на то, что свеча состоит только из 7-9 составных частей, серийное производство очень сложно и требует технологическое оборудование созданное передовыми мировыми фирмами.

Для изготовления свечей зажигания «BRISK» применяются самые качественные материалы поставляемые специализированными фирмами.

Применение самых качественных материалов, передовая технология, сертификация системы управления качеством в соответствии с ISO/TS 16949 и ISO 14001 и соответственный НИ центр со своими оборудованным лабораториями - это предпосылки для выпуска свечей выполняющих все требования изготовителей двигателей.

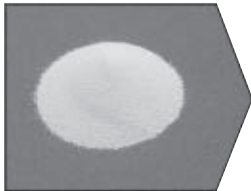

SYSTEM ZNAČENÍ

příklad: **DOR15YC-1**

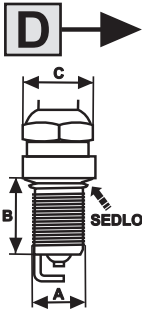

ROZMĚRY POUZDRA

A B C D E F G H J K L M N NA P Q R S T U 3V

TYP	A	B	C	KUŽELOVÉ SEDLO	PODLOŽKA
A	M10x1,00	19mm	16mm		●
B	M12x1,25	19mm	16mm		●
C	M10x1,00	26,5mm	14mm		●
D	M14x1,25	19mm	16mm		●
E	M14x1,25	26,5mm	16mm		●
F	M18x1,50	11,2mm	21mm	●	
G	M14x1,25	17,5mm	16mm	●	
H	M14x1,25	11,2mm	16mm	●	
J	M14x1,25	9,5mm	21mm		●
K	M14x1,25	9,5mm	21mm		●
L	M14x1,25	19mm	21mm		●

TYP	A	B	C	KUŽELOVÉ SEDLO	PODLOŽKA
M	M12x1,25	26,5mm	14mm		●
N	M14x1,25	12,7mm	21mm		●
NA	M10x1,00	12,7mm	16mm		●
P	M14x1,25	9mm	19mm		●
Q	M12x1,25	26,5mm	16mm		●
R	M14x1,25	25mm	16mm	●	
S	M10x1,00	9,5mm	16mm		●
T	M10x1,00	12,7mm	16mm		●
U	M14x1,25	7,8mm	16mm	●	
3V	M16x1,50	20,5mm	14,2mm	●	
X	M12x1,25	25,7mm	14mm	●	



VYSUNUTÍ POUZDRA DO SPALOVACÍHO PROSTORU

- Odpovídá příslušné normě ISO
- Speciální provedení (odpovídá příslušné normě ISO)



ODRUŠENÍ

- Bez odrušovacího odporu
- S odrušovacím odporem
- S odrušovacím odporem pro snížení opalů elektrod



TEPELNÁ HODNOTA

19 18 17 16 15 14 12 11 10 09 08
Teplá ← → Studená



KONSTRUKCE JISKŘIŠTĚ

- Nevysunutá špička izolátoru
- Vysunutá špička izolátoru
- Extrémně vysunutá špička izolátoru
- Dvě vnější elektrody
- Tři vnější elektrody
- Kruhové jiskřiště
- Dvě pomocné elektrody na špičce izolátoru a kruhové jiskřiště
- Speciální provedení jiskřiště



MATERIÁL ELEKTROD

- Střední elektroda ze slitiny niklu
- Střední elektroda s měděným jádrem
- Střední a vnější elektroda legovaná ytrem s měděným jádrem
- Stříbrná střední elektroda
- Střední elektroda s platinovým kontaktem
- Střední elektroda s iridiovým kontaktem



ELEKTRODOVÁ VZDÁLENOST

- 0,4-0,8 mm
- 1 1,0-1,1 mm
- 3 1,3 mm
- 5 1,5 mm
- 9 0,9 mm
- T Speciální provedení



OBJEDNACÍ ČÍSLO (CODE)



IDENTIFICATION SYSTEM

example: **DOR15YC-1**

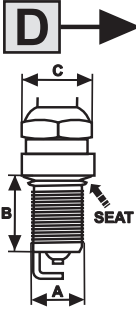

METAL SHELL DIMENSIONS

TYPE	A	B	C	CONICAL SEAT	GASKET SEAT
A	M10x1,00	19mm	16mm		●
B	M12x1,25	19mm	16mm		●
C	M10x1,00	26,5mm	14mm		●
D	M14x1,25	19mm	16mm		●
E	M14x1,25	26,5mm	16mm		●
F	M18x1,50	11,2mm	21mm	●	
G	M14x1,25	17,5mm	16mm	●	
H	M14x1,25	11,2mm	16mm	●	
J	M14x1,25	9,5mm	21mm		●
K	M14x1,25	9,5mm	21mm		●
L	M14x1,25	19mm	21mm		●

TYPE	A	B	C	CONICAL SEAT	GASKET SEAT
M	M12x1,25	26,5mm	14mm		●
N	M14x1,25	12,7mm	21mm		●
NA	M10x1,00	12,7mm	16mm		●
P	M14x1,25	9mm	19mm		●
Q	M12x1,25	26,5mm	16mm		●
R	M14x1,25	25mm	16mm	●	
S	M10x1,00	9,5mm	16mm		●
T	M10x1,00	12,7mm	16mm		●
U	M14x1,25	7,8mm	16mm	●	
3V	M16x1,50	20,5mm	14,2mm	●	
X	M12x1,25	25,7mm	14mm	●	

METAL SHELL PROJECTED INTO COMBUSTION CHAMBER

- O** Complies with relevant ISO standard
- O** Special design (complies with relevant ISO standard)

INTERFERENCE SUPPRESSION

- R** No interference suppression
- R** Interference suppression
- X** Resistor reducing electrode burn-off

HEAT RANGE

- 15** **19** **18** **17** **16** **15** **14** **12** **11** **10** **09** **08**
- Hot ← → Cold

SPARK GAP DESIGN

- Y** Not projected insulator nose
- Y** Projected insulator nose
- L** Extremely projected insulator nose
- D** Two electrodes
- T** Three electrodes
- G** Ring-shaped electrode
- Z** Two auxiliary electrodes on the insulator nose and ring-shaped electrode gap
- M** Special design of spark gap

ELECTRODE MATERIAL

- C** Nickel-alloy centre electrode
- C** Copper cored centre electrode
- E** Copper cored both centre and ground electrode alloyed with yttrium
- S** Silver centre electrode
- P** Centre electrode with platinum contact
- IR** Centre electrode with iridium contact

SPARK GAP

- 1** 0,4-0,8 mm
- 1** 1,0-1,1 mm
- 3** 1,3 mm
- 5** 1,5 mm
- 9** 0,9 mm
- T** Special design



ORDER No (CODE)



СИСТЕМА ОБОЗНАЧЕНИЯ

пример: **DOR15YC-1**



РАЗМЕР КОРПУСА

ТИП	A	B	C	Уплотнение конусом	Уплотнение прокладкой
A	M10x1,00	19мм	16мм		●
B	M12x1,25	19мм	16мм		●
C	M10x1,00	26,5мм	14мм		●
D	M14x1,25	19мм	16мм		●
E	M14x1,25	26,5мм	16мм		●
F	M18x1,50	11,2мм	21мм	●	
G	M14x1,25	17,5мм	16мм	●	
H	M14x1,25	11,2мм	16мм	●	
J	M14x1,25	9,5мм	21мм		●
K	M14x1,25	9,5мм	21мм		●
L	M14x1,25	19мм	21мм		●

ТИП	A	B	C	Уплотнение конусом	Уплотнение прокладкой
M	M12x1,25	26,5мм	14мм		●
N	M14x1,25	12,7мм	21мм		●
NA	M10x1,00	12,7мм	16мм		●
P	M14x1,25	9мм	19мм		●
Q	M12x1,25	26,5мм	16мм		●
R	M14x1,25	25мм	16мм	●	
S	M10x1,00	9,5мм	16мм		●
T	M10x1,00	12,7мм	16мм		●
U	M14x1,25	7,8мм	16мм	●	
3V	M16x1,50	20,5мм	14,2мм	●	
X	M12x1,25	25,7мм	14мм	●	

- O** **ПОМЕЩЕНИЕ КОРПУСА В ЦИЛИНДРЕ**
- Соответствует норме «ИСО»
 - Специальная конструкция (соответствует норме «ИСО»)

- R** **ПОМЕХОЗЩИЩЕННОСТЬ**
- Без защитного сопротивления
 - С защитным сопротивлением
 - С защитным сопротивлением от угара электродов

- 15** **КАПИЛЬНОЕ ЧИСЛО**
- 19 18 17 16 15 14 12 11 10 09 08
- Терлая ← → Холодная

- Y** **СТРОИТЕЛЬСТВО РАЗРЯДНИКА**
- Невынесенный изолятор
 - Вынесенный изолятор
 - Особо вынесенный изолятор
 - Два боковых электрода
 - Три боковых электрода
 - Сплошной электрод по периметру
 - Два вспомогательных электрода на изоляторе и сплошной электрод по периметру
 - Специальная версия разрядника

- C** **МАТЕРИАЛ ЭЛЕКТРОДОВ**
- Центральный электрод из сплава никеля
 - Центральный электрод с сердечником из меди
 - Центральный и боковой электроды, легированные иттрием с медным сердечником
 - Центральный электрод из серебра
 - Центральный электрод с контактом из платины
 - Центральный электрод с контактом из иридия

- 1** **РАССТОЯНИЕ ЭЛЕКТРОДОВ**
- 0,4-0,8 мм
 - 1 1,0-1,1 мм
 - 3 1,3 мм
 - 5 1,5 мм
 - 9 0,9 мм
 - T Специальная конструкция





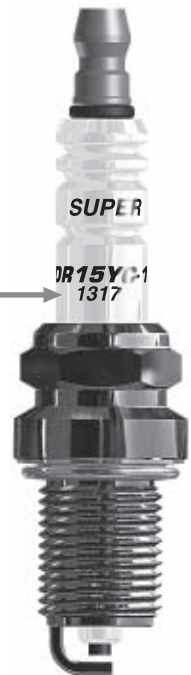





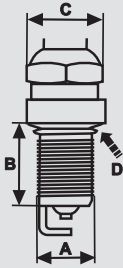



ЗАКАЗАТЬ НОМЕР (CODE)



CLASSIC

TYPE CODE 









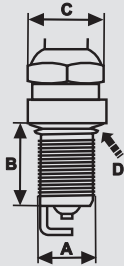

<p>J</p> <p>A - M14x1,25 B - 9,5mm C - 21mm D -  !</p> <p> 20-30 Nm !</p> <p>K</p> <p>A - M14x1,25 B - 9,5mm C - 21mm D -  !</p> <p> 20-30 Nm !</p> <p>L</p> <p>A - M14x1,25 B - 19mm C - 21mm D -  !</p> <p> 20-30 Nm !</p> <p>P</p> <p>A - M14x1,25 B - 9mm C - 19mm D -  !</p> <p> 20-30 Nm !</p> <p>T</p> <p>A - M10x1,00 B - 12,7mm C - 16mm D -  !</p> <p> 10-15 Nm !</p> <p>U</p> <p>A - M14x1,25 B - 7,8mm C - 16mm D -  !</p> <p> 10-20 Nm !</p>	<p>J17 J19 JR17 JR19</p>	<p>3054 3044 3053 3043</p>	<p>J1 J1 J1 J1</p>
	<p>K17Y K19</p>	<p>1063 1420</p>	<p>K2 K1</p>
	<p>L19</p>	<p>1010</p>	<p>L1</p>
	<p>P15 P17 P15Y P17Y P18Y PR15 PR17 PR15Y PR17Y PR18Y</p>	<p>3051 3052 3037 3023 3039 3049 3050 3022 3021 3038</p>	<p>P1 P1 P2 P2 P2 P1 P1 P2 P2 P2</p>
	<p>TR17</p>	<p>3138</p>	<p>T1</p>
	<p>U15 U17 U17Y UR15 UR17 UR17Y</p>	<p>3007 3006 3067 3063 3064 3065</p>	<p>U1 U1 U2 U1 U1 U2</p>



SUPER

TYPE CODE 









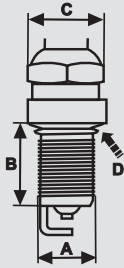



 20-30 Nm !	D A - M14x1,25 B - 19mm C - 16mm D - 	D17YC DR15YC DR17YC DR17YC-9	1359 1327 1326 1571	D2 D2 D2 D2
	F A - M18x1,5 B - 11,2mm C - 21mm D - 	FR15YC FR17YC	1367 1456	F2 F2
	G A - M14x1,25 B - 17,5mm C - 16mm D - 	G17YC GR15YC GR17YC	1368 1362 1389	G2 G2 G2
	H A - M14x1,25 B - 11,2mm C - 16mm D - 	HR17YC	1507	H2
	K A - M14x1,25 B - 9,5mm C - 21mm D - 	K15YC K17C	1438 1433	K2 K1
	L A - M14x1,25 B - 19mm C - 21mm D - 	L14C L15C L17C L14YC L15YC L17YC LR14C LR15C LR14YC LR15YC LR15YC-1 LR15YC-9 LR17YC LR17YC-1 LR17YC-9	1344 1468 1321 1361 1313 1338 1485 1472 1370 1314 1315 1572 1322 1365 1573	L1 L1 L1 L2 L2 L2 L1 L1 L2 L2 L2 L2 L2 L2



SUPER







	TYPE	CODE	
N A - M14x1,25 B - 12,7mm C - 21mm D -   20-30 Nm !	N14C	1319	N1
	N15C	1330	N1
	N17C	1320	N1
	N19C	1363	N1
	N14YC	1360	N2
	N15YC	1341	N2
	N17YC	1544	N2
	NR14C	1434	N1
	NR15C	1386	N1
	NR17C	1371	N1
	NR12YC	1486	N2
	NR15YC	1339	N2
NR17YC	1340	N2	
NA A - M10x1,00 B - 12,7mm C - 16mm D -   10-15 Nm !	NAR14YC	1551	NA2
P A - M14x1,25 B - 9mm C - 19mm D -   20-30 Nm !	PR17YC	3130	P2
	PR17YC*	3159	P2
S A - M10x1,00 B - 9,5mm C - 16mm D -   10-15 Nm !	SR14C	3158	S1
	SR15C		S1
T A - M10x1,00 B - 12,7mm C - 16mm D -   10-15 Nm !	TR14C	3140	T1
	TR15C	3153	T1
	TR17C	3161	T1

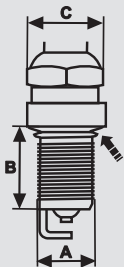

- * Vysokonapětové připojení (monoblok)
- * H.V. Terminal (monoblock)
- * Подключение высокого напряжения (моноблок)

A-line YTTTRIUM





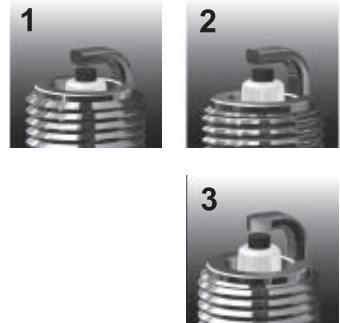



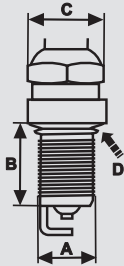





	TYPE	CODE	
A A - M14x1,25 B - 19mm C - 21mm D -   20-30 Nm !	A	0020	L3



SILVER



	TYPE	CODE	
<p>D</p> <p>A - M14x1,25 B - 19mm C - 16mm D - </p> <p> 20-30 Nm !</p> <p>G</p> <p>A - M14x1,25 B - 17,5mm C - 16mm D - </p> <p> 10-20 Nm !</p> <p>L</p> <p>A - M14x1,25 B - 19mm C - 21mm D - </p> <p> 20-30 Nm !</p> <p>N</p> <p>A - M14x1,25 B - 12,7mm C - 21mm D - </p> <p> 20-30 Nm !</p> <p>NA</p> <p>A - M10x1,00 B - 12,7mm C - 16mm D - </p> <p> 10-15 Nm !</p> <p>T</p> <p>A - M10x1,00 B - 12,7mm C - 16mm D - </p> <p> 10-15 Nm !</p>	<p>DR15YS DR17YS DR17YS-9</p>	<p>1334 1351 1463</p>	<p>D2 D2 D2</p>
	<p>GR15YS-9 GR17YS</p>	<p>1577 1576</p>	<p>G2 G2</p>
	<p>LR14S LR15S LR14YS LR15YS LR15YS-9 LR17YS LR17YS-9</p>	<p>1555 1147 1353 1332 1464 1333 1465</p>	<p>L1 L1 L2 L2 L2 L2 L2</p>
	<p>NR14S NR15S</p>	<p>1432 1354</p>	<p>N1 N1</p>
	<p>NAR14YS NAR15YS</p>	<p>1541 1542</p>	<p>NA2 NA2</p>
	<p>TR14S</p>	<p>3139</p>	<p>T1</p>



BRISK®



CATALOGUE / KATALOG / КАТАЛОГ
2014



GARDEN



WWW.BRISK.CZ



**STANDARD
BRISK**

**ALTERNATIVE
BRISK**

AA-TACH

MALOTRAKTORY • TRACTORS • МАЛОГАБАРИТНЫЕ ТРАКТОРЫ

EH 65X, EH 65V (V-Twin)	0,6	LR15YC	SUPER	LR15YS	SILVER
EY 21 (Wisconsin-Robin)		K19	CLASSIC		
Robin - 20 HP, 20,5 HP / (OHV)	0,6	LR15YC	SUPER	LR15YS	SILVER

ACE

ELEKTROCENTRÁLY / STACIONÁRNÍ MOTORY • ELEKTROCENTRALS / STATIONARY ENGINES • ЭЛЕКТРИЧЕСКИЕ КОММУТАТОРЫ / СТАЦИОНАРНЫЕ ДВИГАТЕЛИ

B & S - 3 HP, 3,5 HP, 4 HP, 5 HP		JR19	CLASSIC		
----------------------------------	--	------	---------	--	--

KULTIVÁTORY • CULTIVATORS • КУЛЬТИВАТОРЫ

B & S - 3, 5 HP, 8 HP		JR19	CLASSIC		
B & S - 10,5 HP, 12 HP, 18 HP		JR19	CLASSIC		

MOTOROVÉ TRAVNÍ SEKAČKY • LAWN MOWER • СЕНОКОСИЛКИ

B & S - 3,5 HP, 4 HP, 5 HP		J19	CLASSIC		
----------------------------	--	-----	---------	--	--

ACME

ELEKTROCENTRÁLY / STACIONÁRNÍ MOTORY • ELEKTROCENTRALS / STATIONARY ENGINES • ЭЛЕКТРИЧЕСКИЕ КОММУТАТОРЫ / СТАЦИОНАРНЫЕ ДВИГАТЕЛИ

A 180B, A 220B, A 230B	0,6	N17YC	SUPER		
A 349, A 360	0,6	N17YC	SUPER		
ACT 280 OHC, ACT 340 OHC	0,6	DR17YC	SUPER	DR17YS	SILVER
AL 75, AL 215, AL 290VWB	0,6	N17YC	SUPER		
AL 330VWB, AL 480WB, AL 550WB	0,6	N17YC	SUPER		
ALN 215WB, ALN 215WP	0,6	N17YC	SUPER		
ALN 290WB, ALN 330WB	0,6	N17YC	SUPER		
AT 220 OHV, AT 330 OHV	0,6	N17YC	SUPER		
ATS 1	0,6	N17YC	SUPER		
VT 88 OHV, VT 94 OHV	0,6	N17YC	SUPER		

AGRIA

KŘOVINOŘEZY • BRUSH CUTTERS • ТРИММЕРЫ

0300 (Rotax)		L15C ^{+R}	SUPER		
3400 (MAG) 4 Stroke	0,6	N15C	SUPER	NR15S	SILVER
3400 (Rotax) 2 Stroke	0,6	N15C	SUPER	NR15S	SILVER
5100 (Kawasaki)	0,5	PR17	CLASSIC		
5200 (B&S), 5300 (B&S)	0,5	JR19	CLASSIC		
5400 (Rotax)		L15C ^{+R}	SUPER		
5500 (Rotax) 2 Stroke	0,6	N15C	SUPER	NR15S	SILVER
5500 (Rotax) 4 Stroke		L15C ^{+R}	SUPER		
IT 25, IT 35, IT 45, IT 48	0,5	P15	CLASSIC		

KULTIVÁTORY • CULTIVATORS • КУЛЬТИВАТОРЫ

B & S 0400 (3,5 HP)	0,5	JR19	CLASSIC		
B & S 5200, 5300	0,5	JR19	CLASSIC		
B & S 100-3, 100-4	0,5	JR19	CLASSIC		
B & S 100-5, 1000-4	0,5	JR19	CLASSIC		
B & S 3100 (4 takt)	0,5	JR19	CLASSIC		
B & S 7200-8 (8 HP)	0,5	JR19	CLASSIC		
B & S 7200-11 (12,5 HP)	0,5	JR19	CLASSIC		
F & S 0200 (2 takt)	0,6	N17C	SUPER		
F & S 0200 (4 takt)	0,5	JR19	CLASSIC		
JLO 3100 (L101 - 2 takt)	0,5	JR17	CLASSIC		
Kawasaki 0500	0,5	JR17	CLASSIC		
3001 (Minsel)		N17C	SUPER		

MALOTRAKTORY • TRACTORS • МАЛОГАБАРИТНЫЕ ТРАКТОРЫ

2400 (JLO - 2 takt)	0,5	N17C	SUPER		
2400 (MAG - 4 takt)	0,5	N17C	SUPER		
3200 (Kawasaki - 6 HP)	0,5	K19	CLASSIC		
3300 (JLO - L25)	0,5	N15C	SUPER	NR15S	SILVER
3300 Max	0,5	N19C	SUPER		
3400 (Rotax)	0,5	N17C	SUPER		
5000-Serie 5200	0,5	K17C	SUPER		
5000-Serie 5900		N15YC	SUPER		



AGRIA

MALOTRAKTORY • TRACTORS • МАЛОГАБАРИТНЫЕ ТРАКТОРЫ

5500 (Rotax - 2 takt)	0,5	N15C	SUPER	NR15S	SILVER
5500 (MAG - 4 takt)	0,5	N15C	SUPER	NR15S	SILVER
6900-2 (Renault - 35 HP)	0,6	LR15YC	SUPER	LR15YS	SILVER
7000-Serie 7900		N15YC	SUPER		

MOTOROVÉ TRAVNÍ SEKAČKY • LAWN MOWER • СЕНОКОСИЛКИ

0300	0,5	N15C	SUPER	NR15S	SILVER
0400 Quickly	0,6	JR17	CLASSIC		
1400	0,5	N15C	SUPER	NR15S	SILVER
Baby 2100 (14mm)	0,5	N19C	SUPER		
Baby 2100 (18mm)		L15C ^{+R}	SUPER		
Baby 4000, Baby 4000S		L15C ^{+R}	SUPER		
Aspera - 3,5 HP (5200R)	0,5	JR17	CLASSIC		
B & S	0,5	JR17	CLASSIC		
F & S	0,5	N14C	SUPER	NR14S	SILVER
F & S - 3,5 HP (5200R)	0,5	N17C	SUPER		
ILO (14 mm / 05.77-)	0,5	N15C	SUPER	NR15S	SILVER
ILO (18 mm / -04.77)		L14C ^{+R}	SUPER		
Lombardini	0,5	N19C	SUPER		
MAG	0,5	N19C	SUPER		
NSU	0,5	N19C	SUPER		
Record		L15C ^{+R}	SUPER		
Renault		N15YC	SUPER		
SW 519, SW 521, SW 621	0,6	LR17YC	SUPER	LR17YS	SILVER

AGROS

ELEKTROCENTRÁLY / STACIONÁRNÍ MOTORY • ELEKTROCENTRALS / STATIONARY ENGINES • ЭЛЕКТРИЧЕСКИЕ КОММУТАТОРЫ / СТАЦИОНАРНЫЕ ДВИГАТЕЛИ

Agros		N17C	SUPER		
-------	--	------	-------	--	--

AGROSTROJ

MALOTRAKTORY • TRACTORS • МАЛОГАБАРИТНЫЕ ТРАКТОРЫ

Motorobot PF-6	0,6	N17C	SUPER		
Motorobot PF-61, Motorobot PF-62 (BD-1-S-72A)	0,6	NR17C	SUPER		

MOTOROVÉ TRAVNÍ SEKAČKY • LAWN MOWER • СЕНОКОСИЛКИ

MF-70	0,6	N17C	SUPER		
-------	-----	------	-------	--	--

AGTRONIC

ELEKTROCENTRÁLY / STACIONÁRNÍ MOTORY • ELEKTROCENTRALS / STATIONARY ENGINES • ЭЛЕКТРИЧЕСКИЕ КОММУТАТОРЫ / СТАЦИОНАРНЫЕ ДВИГАТЕЛИ

B & S		P17	CLASSIC		
-------	--	-----	---------	--	--

AGWAY

MOTOROVÉ PILY • CHAINSAW • МОТОПИЛЫ

754		K17C	SUPER		
PL 4, PL 5, PL 6		P15	CLASSIC		

AGZAT

KULTIVÁTORY • CULTIVATORS • КУЛЬТИВАТОРЫ

AGZAT - B & S Intek Pro 65 (6,5HP)		DR17YC	SUPER	DR17YS	SILVER
AGZAT - Honda GCV 160 (5,5HP)		LR15YC	SUPER	LR15YS	SILVER

AL-KO

ELEKTROCENTRÁLY / STACIONÁRNÍ MOTORY • ELEKTROCENTRALS / STATIONARY ENGINES • ЭЛЕКТРИЧЕСКИЕ КОММУТАТОРЫ / СТАЦИОНАРНЫЕ ДВИГАТЕЛИ

750 B	0,5	JR19	CLASSIC		
B & S 12,5-17 HP (OHV)		DR17YC	SUPER	DR17YS	SILVER
B & S 12,5-20 HP (+AVS, V1 / V2)		DR17YC	SUPER	DR17YS	SILVER
B & S 10,5-13,5 HP	0,5	JR19	CLASSIC		
B & S (4 Takt)	0,5	JR17	CLASSIC		
Honda (4 Takt)		LR17YC	SUPER	LR17YS	SILVER
Tecumseh (4 Takt)		K17C	SUPER		
Tecumseh 11-13 HP (OHV)		LR14C	SUPER	LR14S	SILVER

KŘOVINOŘEZY • BRUSH CUTTERS • ТРИММЕРЫ

18, 24, 33, 40		P17	CLASSIC		
250		U17Y	CLASSIC		



service
instructions

... BOSCH ...
... CHAMPION ...
... NGK ...



cross reference



LAST INFO



**STANDARD
BRISK** 

**ALTERNATIVE
BRISK** 

AL-KO

KŘOVINOŘEZY • BRUSH CUTTERS • ТРИММЕРЫ

BC 300 (Homelite)		UR17Y	CLASSIC		
BC 330T (Kawasaki), BC 400T (Kawasaki)		P17	CLASSIC		
HS 4300, HS 5300		UR17Y	CLASSIC		
LT 250 (Homelite)		UR17Y	CLASSIC		

KULTIVÁTORY • CULTIVATORS • КУЛЬТИВАТОРЫ

B & S Alko Trac 1082	0,5	J19	CLASSIC		
B & S FB 25-80RT	0,6	J19	CLASSIC		

MOTOROVÉ PÍLY • CHAINSAW • МОТОПИЛЫ

KB 3501, KB 4001	0,5	PR15Y	CLASSIC	PR17YC	SUPER
KB 4501, KB 5000	0,5	PR15Y	CLASSIC	PR17YC	SUPER

MOTOROVÉ TRAVNÍ SEKAČKY • LAWN MOWER • СЕНОКОСИЛКИ

Aspera	0,5	J17	CLASSIC		
B & S 10,5 - 13,5 HP		JR19	CLASSIC		
B & S 12,5 - 17 HP (OHV)		DR17YC	SUPER	DR17YS	SILVER
B & S 12,5 - 20 HP (+ AVS, V1 / V2)		DR17YC	SUPER	DR17YS	SILVER
B & S (4 Takt)	0,5	JR17	CLASSIC		
Honda (4 Takt)		DR17YC	SUPER	DR17YS	SILVER
Tecumseh (4 Takt)		K17C	SUPER		
Tecumseh 11-13 HP (OHV)		LR14C	SUPER	LR14S	SILVER

ALLEN

KŘOVINOŘEZY • BRUSH CUTTERS • ТРИММЕРЫ

20 SDS		P17	CLASSIC		
22 Deluxe, 22 Domestic	0,5	P17	CLASSIC		
22 Super, 22 Mini		P15	CLASSIC		
26 Mini		P15	CLASSIC		
Pro 26		P15	CLASSIC		
Pro 37 (Xenoah)	0,5	N17C	SUPER		
Super 657 (Tecumseh)	0,9	J17	CLASSIC		

MALOTRAKTORY • TRACTORS • МАЛОГАБАРИТНЫЕ ТРАКТОРЫ

832 Lawnride 8E (B&S)		JR19	CLASSIC		
-----------------------	--	------	---------	--	--

MOTOROVÉ PÍLY • CHAINSAW • МОТОПИЛЫ

HF 108		P17	CLASSIC		
HT 230 A		P15	CLASSIC		
STP 102		P17	CLASSIC		

MOTOROVÉ TRAVNÍ SEKAČKY • LAWN MOWER • СЕНОКОСИЛКИ

Suzuki (120ccm)	0,8	P17Y	CLASSIC	PR17YC	SUPER
-----------------	-----	------	---------	--------	-------

ALLIS-CHALMERS

MALOTRAKTORY • TRACTORS • МАЛОГАБАРИТНЫЕ ТРАКТОРЫ

FPL 40, FPL 50, FPL 60, FPL 70, FPL 80-24	0,6	L17C	SUPER		
FS 60, FS 70, FS 80-24	0,6	L17C	SUPER		
FT 70, FT 80, FT 100-24		K17C	SUPER		
FTD 75-24 C		K17C	SUPER		
FTL 70, FTL 80, FTL 100-24		K17C	SUPER		
FTP 30, FTP 40-24	0,5	K19	CLASSIC		
FTP 60-24	0,5	K17C	SUPER		
FTPL 30, FTPL 40-24	0,5	K19	CLASSIC		
FTPL 60-24	0,5	K17C	SUPER		
G (G-301)	0,6	L17C	SUPER		
H 3 (G-149)		K17C	SUPER		
P 40, P 50, P 60, P 70, P 80-24	0,6	L17C	SUPER		
RT 40 (G-149 / G-153)		K17C	SUPER		
RTD 40 (G-149 / G-153)		K17C	SUPER		

MOTOROVÉ PÍLY • CHAINSAW • МОТОПИЛЫ

65 / 75 / 75A / 95 / 195 / 295		P17	CLASSIC		
--------------------------------	--	-----	---------	--	--

MOTOROVÉ TRAVNÍ SEKAČKY • LAWN MOWER • СЕНОКОСИЛКИ

All models		J19	CLASSIC		
------------	--	-----	---------	--	--



STANDARD
BRISK

ALTERNATIVE
BRISK

ALPINA

KŘOVINOŘEZY • BRUSH CUTTERS • ТРИММЕРЫ

18 TS	0,5	PR17Y	CLASSIC	PR17YC	SUPER
160 Gren, 180 Jolly	0,5	P15	CLASSIC		
210 Flex	0,5	P15	CLASSIC		
200 Prof	0,5	PR15Y	CLASSIC	PR17YC	SUPER
232, 238, 332, 338	0,5	PR15Y	CLASSIC	PR17YC	SUPER
540i, 600i	0,5	PR15Y	CLASSIC	PR17YC	SUPER
Vip 21, Vip 25, Vip 30, Vip 34	0,5	PR17Y	CLASSIC	PR17YC	SUPER
Vip 34 Duplex, Vip 34 Flex	0,5	PR17Y	CLASSIC	PR17YC	SUPER

MALOTRAKTORY • TRACTORS • МАЛОГАБАРИТНЫЕ ТРАКТОРЫ

All models	0,5	P15	CLASSIC		
------------	-----	-----	---------	--	--

MOTOROVÉ PÍLY • CHAINSAW • МОТОПИЛЫ

330, 380, 432, 438	0,5	PR15Y	CLASSIC	PR17YC	SUPER
A-35, A-40, A-40E, A-70, A-90	0,5	PR15Y	CLASSIC	PR17YC	SUPER
Forest 120	0,5	PR15Y	CLASSIC	PR17YC	SUPER
O-70, O-70S	0,5	PR15Y	CLASSIC	PR17YC	SUPER
P 400, P 450	0,5	PR17Y	CLASSIC	PR17YC	SUPER
P 700, P 800	0,5	PR15Y	CLASSIC	PR17YC	SUPER
Prof 34	0,5	PR15Y	CLASSIC	PR17YC	SUPER
Prof 41, Prof 45	0,5	PR15Y	CLASSIC	PR17YC	SUPER
Prof 55, Prof 56	0,5	PR15Y	CLASSIC	PR17YC	SUPER
Prof 65, Prof 66	0,5	PR15Y	CLASSIC	PR17YC	SUPER
Prof 70, Prof 90	0,5	PR15Y	CLASSIC	PR17YC	SUPER
Prof 120	0,5	PR15Y	CLASSIC	PR17YC	SUPER
Vip 20, Vip 24, Vip 32	0,5	PR15Y	CLASSIC	PR17YC	SUPER

MOTOROVÉ TRAVNÍ SEKAČKY • LAWN MOWER • СЕНОКОСИЛКИ

Elite 40L, Elite 404	0,6	JR17	CLASSIC		
Hobby 202	0,6	JR17	CLASSIC		

AMERIND-MACKISSIC

MOTOROVÉ PÍLY • CHAINSAW • МОТОПИЛЫ

9P		K19	CLASSIC		
----	--	-----	---------	--	--

ARCTIC CAT

ELEKTROCENTRÁLY / STACIONÁRNÍ MOTORY • ELEKTROCENTRALS / STATIONARY ENGINES • ЭЛЕКТРИЧЕСКИЕ КОММУТАТОРЫ / СТАЦИОНАРНЫЕ ДВИГАТЕЛИ

AC 1400G - 3,8 HP (119 ccm - 4Stroke)	0,6	LR15YC	SUPER	LR15YS	SILVER
AC 1800GD	0,6	LR15YC	SUPER	LR15YS	SILVER
AC 2200G	0,6	LR15YC	SUPER	LR15YS	SILVER
AC 2500G - 5,3 HP (162 ccm - 4Stroke)	0,6	LR15YC	SUPER	LR15YS	SILVER
AC 2500GD - 5,3 HP (162 ccm - 4Stroke)	0,6	LR15YC	SUPER	LR15YS	SILVER
AC 3000GD2 - 6,8 HP (252 ccm - 4Stroke)	0,6	NR17YC	SUPER		
AC 4000G2 - 9 HP (272ccm - 4Stroke)	0,6	LR17YC	SUPER	LR17YS	SILVER
AC 4000GD2E - 9 HP (272 ccm - 4Stroke)	0,6	LR17YC	SUPER	LR17YS	SILVER
AC 7500GD2E - 14 HP (419 ccm - 4Stroke)	0,5	LR15C	SUPER	LR15S	SILVER
AC 7500GT - 1,8 HP (70 ccm - 2Stroke)	0,6	NR17YC	SUPER		

ARGEST

MOTOROVÉ PÍLY • CHAINSAW • МОТОПИЛЫ

255		P17	CLASSIC		
-----	--	-----	---------	--	--

AS MOTOR

ELEKTROCENTRÁLY / STACIONÁRNÍ MOTORY • ELEKTROCENTRALS / STATIONARY ENGINES • ЭЛЕКТРИЧЕСКИЕ КОММУТАТОРЫ / СТАЦИОНАРНЫЕ ДВИГАТЕЛИ

AS 120A, AS 120C, AS 120D	0,6	N15C	SUPER	NR15S	SILVER
AS 165A, AS 165D, AS 165E, AS 165F	0,6	N15C	SUPER	NR15S	SILVER
AS 165G, AS 165H, AS 165I, AS 165K	0,6	N15C	SUPER	NR15S	SILVER
AS 165L, AS 165M, AS 165N	0,6	N15C	SUPER	NR15S	SILVER
S-B 6	0,5	N15C	SUPER	NR15S	SILVER

ASPERA

ELEKTROCENTRÁLY / STACIONÁRNÍ MOTORY • ELEKTROCENTRALS / STATIONARY ENGINES • ЭЛЕКТРИЧЕСКИЕ КОММУТАТОРЫ / СТАЦИОНАРНЫЕ ДВИГАТЕЛИ

AV 125		K19	CLASSIC		
AV 600		K19	CLASSIC		



service
instructions

... BOSCH ...
... CHAMPION ...
... NGK ...



BRISK

LAST INFO



STANDARD
BRISK

ALTERNATIVE
BRISK

ASPERA

ELEKTROCENTRÁLY / STACIONÁRNÍ MOTORY • ELEKTROCENTRALS / STATIONARY ENGINES • ЭЛЕКТРИЧЕСКИЕ КОММУТАТОРЫ / СТАЦИОНАРНЫЕ ДВИГАТЕЛИ

AV 600 D.P.		K19	CLASSIC	
AV 750		P15	CLASSIC	
BUR 172		K19	CLASSIC	
HBL 25, HBL 30		K19	CLASSIC	
HBL 35, HBL 40		K19	CLASSIC	
HBLR 35		K19	CLASSIC	
HBP 40		K19	CLASSIC	
HS 25, HS 30, HS 35, HS 40	0,6	JR19	CLASSIC	
LAV 30, LAV 35, LAV 40	0,6	JR19	CLASSIC	
LAV 153, LAV 153 D.P.	0,6	JR19	CLASSIC	
LAV 172, LAV 173	0,6	JR19	CLASSIC	
MV 100 S		K19	CLASSIC	

ASTRON

ELEKTROCENTRÁLY / STACIONÁRNÍ MOTORY • ELEKTROCENTRALS / STATIONARY ENGINES • ЭЛЕКТРИЧЕСКИЕ КОММУТАТОРЫ / СТАЦИОНАРНЫЕ ДВИГАТЕЛИ

AS-110	0,6	N17C	SUPER	
--------	-----	------	-------	--

KŘOVINOŘEZY • BRUSH CUTTERS • ТРИММЕРЫ

KFS 4-12AD, KFS 4-24DX		P17	CLASSIC	
P-750ED		P17	CLASSIC	
S-150, S-200, S-250		P17	CLASSIC	
ST-16 (Shingu)		P15	CLASSIC	

ATLAS

ELEKTROCENTRÁLY / STACIONÁRNÍ MOTORY • ELEKTROCENTRALS / STATIONARY ENGINES • ЭЛЕКТРИЧЕСКИЕ КОММУТАТОРЫ / СТАЦИОНАРНЫЕ ДВИГАТЕЛИ

B & S - 3 HP	0,6	J19	CLASSIC	
B & S - 5 HP	0,6	J19	CLASSIC	
B & S - 8 HP	0,6	J19	CLASSIC	
Tecumseh	0,8	K19	CLASSIC	

BARBER-GREENE

MALOTRAKTORY • TRACTORS • МАЛОГАБАРИТНЫЕ ТРАКТОРЫ

840 B, 879 B (Herc.GO-226)		K17C	SUPER	
SA 40 (IHC-UB-240)		K17C	SUPER	
SI 50 (IHC-UB-240)		K17C	SUPER	

BARKER INDUSTRIES

MOTOROVÉ PÍLY • CHAINSAW • МОТОПИЛЫ

50012 (Chrysler)		P17	CLASSIC	
------------------	--	-----	---------	--

BCB

ELEKTROCENTRÁLY / STACIONÁRNÍ MOTORY • ELEKTROCENTRALS / STATIONARY ENGINES • ЭЛЕКТРИЧЕСКИЕ КОММУТАТОРЫ / СТАЦИОНАРНЫЕ ДВИГАТЕЛИ

A 40, A 44, A 52	0,5	N15C	SUPER	NR15S SILVER
A 51	0,5	N14C	SUPER	NR14S SILVER

BCS

MALOTRAKTORY • TRACTORS • МАЛОГАБАРИТНЫЕ ТРАКТОРЫ

303	0,5	N19C	SUPER	
601, 604	0,5	N19C	SUPER	
640, 645		LR15YC	SUPER	LR15YS SILVER
715, 725, 735, 737, 745, 755	0,5	N19C	SUPER	

BERTOLINI

MALOTRAKTORY • TRACTORS • МАЛОГАБАРИТНЫЕ ТРАКТОРЫ

126, 134, 136	0,5	N19C	SUPER	
306, 308 / (Acme-AL 330)	0,5	N17C	SUPER	
306 (IM 300)	0,5	N19C	SUPER	
308 (350), 310S, 312	0,5	N19C	SUPER	
315 (IM 300, LA 490)	0,5	N19C	SUPER	
406, 408	0,5	N19C	SUPER	

BETA-INTERMOTOR

ELEKTROCENTRÁLY / STACIONÁRNÍ MOTORY • ELEKTROCENTRALS / STATIONARY ENGINES • ЭЛЕКТРИЧЕСКИЕ КОММУТАТОРЫ / СТАЦИОНАРНЫЕ ДВИГАТЕЛИ

B 5Z, B 81, B 101	0,5	K17C	SUPER	
B 40, B 50, B 90	0,5	N17C	SUPER	



BETA-INTERMOTOR

ELEKTROCENTRÁLY / STACIONÁRNÍ MOTORY • ELEKTROCENTRALS / STATIONARY ENGINES • ЭЛЕКТРИЧЕСКИЕ КОММУТАТОРЫ / СТАЦИОНАРНЫЕ ДВИГАТЕЛИ

B 110, B 125, B 125R, B 140	0,5	N17C	SUPER		
B 147, BP 147, B 152, B 155	0,5	N17C	SUPER		
B 157, B 175	0,5	N17C	SUPER		
B 177, B 205	0,5	N17C	SUPER		
BP 90, B 97, BP 97	0,5	N17C	SUPER		
BP 110, B 117, BP 117	0,5	N17C	SUPER		
BP 140	0,5	N17C	SUPER		
BP 155, BP 157	0,5	N17C	SUPER		
BP 175, BP 177, BP 207	0,5	N17C	SUPER		

BLITZ

MOTOROVÉ PILY • CHAINSAW • МОТОПИЛЫ

B 34, B 35, B 38, B 42	0,5	PR17Y	CLASSIC	PR17YC	SUPER
B 45, B 50, B 52, B 54	0,5	PR17Y	CLASSIC	PR17YC	SUPER
B 55, B 60, B 64, B 80	0,5	PR17Y	CLASSIC	PR17YC	SUPER
B 100F, B 300, B 304	0,5	PR17Y	CLASSIC	PR17YC	SUPER
B 400, B 404, B 500	0,5	PR17Y	CLASSIC	PR17YC	SUPER
B 502, B 504, B 600	0,5	PR17Y	CLASSIC	PR17YC	SUPER
B 701, B 702	0,5	PR17Y	CLASSIC	PR17YC	SUPER
B 800, B 802, B 804	0,5	PR17Y	CLASSIC	PR17YC	SUPER

BLUEBIRD INDUSTRIES

ELEKTROCENTRÁLY / STACIONÁRNÍ MOTORY • ELEKTROCENTRALS / STATIONARY ENGINES • ЭЛЕКТРИЧЕСКИЕ КОММУТАТОРЫ / СТАЦИОНАРНЫЕ ДВИГАТЕЛИ

E 27 E		P15	CLASSIC		
EBC 27E		P15	CLASSIC		
EPM 27E		P15	CLASSIC		
N 03, N 04		N15C	SUPER	NR15S	SILVER
N 31E, N 38E		N15C	SUPER	NR15S	SILVER
NAE 03, NAE 04	0,6	N15C	SUPER	NR15S	SILVER
NB 38E		N15C	SUPER	NR15S	SILVER
NBC 03, NBC 04	0,6	N15C	SUPER	NR15S	SILVER
NBC 31E		N15C	SUPER	NR15S	SILVER
NPM 03, NPM 31E		N15C	SUPER	NR15S	SILVER
S 23E		P15	CLASSIC		
SBC 23E		P15	CLASSIC		
SEC 23E		P15	CLASSIC		

BOLENS

MALOTRAKTORY • TRACTORS • МАЛОГАБАРИТНЫЕ ТРАКТОРЫ

528 (B & S - 5HP)	0,5	JR19	CLASSIC		
830, 831 (B & S - 8 HP)	0,5	JR19	CLASSIC		
G 11YT (B & S)	0,5	JR19	CLASSIC		
G 12XL (Tecumseh)	0,5	JR17	CLASSIC		
G 16YT (B & S - 16 HP)	0,5	JR19	CLASSIC		
G 16X-1 (Tecumseh)	0,5	JR17	CLASSIC		
G 16XT (B & S - 16 HP)	0,5	JR19	CLASSIC		
H 11YT (B & S)	0,5	JR19	CLASSIC		
H 12XL (Tecumseh)	0,5	JR17	CLASSIC		
H 16X-1 (Tecumseh)	0,5	JR17	CLASSIC		
H 16XT (B & S - 16 HP)	0,5	JR19	CLASSIC		

MOTOROVÉ PILY • CHAINSAW • МОТОПИЛЫ

Other models		K19	CLASSIC		
3010 Thrifty, 3014 Swiftly		K17C	SUPER		

MOTOROVÉ TRAVNÍ SEKAČKY • LAWN MOWER • СЕНОКОСИЛКИ

8325 (B & S - 3,5 HP)	0,5	JR19	CLASSIC		
8362 (B & S - 4 HP)	0,5	JR19	CLASSIC		
8372 (Tecumseh - 3,7 HP)	0,5	JR17	CLASSIC		
8554, 8555E / (Tecumseh - 5 HP)	0,5	JR17	CLASSIC		
8618, 8621 / (B & S - 3,5 HP)	0,5	JR19	CLASSIC		



service instructions

... BOSCH ...
... CHAMPION ...
... NGK ...



LAST INFO



**STANDARD
BRISK**

**ALTERNATIVE
BRISK**

BOLENS

MOTOROVÉ TRAVNÍ SEKAČKY • LAWN MOWER • СЕНОКОСИЛКИ

8635, 8638 / (B & S - 3,5 HP)	0,5	JR19	CLASSIC		
8644, 8648 / (B & S - 4 HP)	0,5	JR19	CLASSIC		
8649 (B & S - 4 HP)	0,5	JR19	CLASSIC		
B & S (Older models)		J19	CLASSIC		
Tecumseh (Older models)		J17	CLASSIC		

BOMBARDIER-ROTAX

ELEKTROCENTRÁLY / STACIONÁRNÍ MOTORY • ELEKTROCENTRALS / STATIONARY ENGINES • ЭЛЕКТРИЧЕСКИЕ КОММУТАТОРЫ / СТАЦИОНАРНЫЕ ДВИГАТЕЛИ

95, 182, 232	0,6	N15C	SUPER	NR15S	SILVER
150, 299, 500		L15C ^{+R}	SUPER		
635		L14C ^{+R}	SUPER		

BOSCH

ELEKTROCENTRÁLY / STACIONÁRNÍ MOTORY • ELEKTROCENTRALS / STATIONARY ENGINES • ЭЛЕКТРИЧЕСКИЕ КОММУТАТОРЫ / СТАЦИОНАРНЫЕ ДВИГАТЕЛИ

Solo	0,5	N17C	SUPER		
------	-----	------	-------	--	--

MALOTRAKTORY • TRACTORS • МАЛОГАБАРИТНЫЕ ТРАКТОРЫ

G 800	0,5	N15C	SUPER	NR15S	SILVER
G 2000S, G 2400S		LR15YC	SUPER	LR15YS	SILVER
G 2300, G 2600	0,5	N14C	SUPER	NR14S	SILVER
G 3500	0,5	N14C	SUPER	NR14S	SILVER
G 3600SP		LR17YC	SUPER	LR17YS	SILVER
G 6500, G 8000	0,6	DR17YC	SUPER	DR17YS	SILVER

BRIGGS & STRATTON

ELEKTROCENTRÁLY / STACIONÁRNÍ MOTORY • ELEKTROCENTRALS / STATIONARY ENGINES • ЭЛЕКТРИЧЕСКИЕ КОММУТАТОРЫ / СТАЦИОНАРНЫЕ ДВИГАТЕЛИ

6,5 HP - 3250		DR17YC	SUPER	DR17YS	SILVER
7,5 HP - Pro 4000 Vanguard OHV		DR17YC	SUPER	DR17YS	SILVER
10 HP - 5000, 5500	0,6	JR19	CLASSIC		
11 HP - 6000	0,6	J19	CLASSIC		
13 HP - Pro 6500 Vanguard OHV		DR17YC	SUPER	DR17YS	SILVER
15 HP - 7000		DR17YC	SUPER	DR17YS	SILVER
16 HP - Pro 8000 V-Twin Vanguard		DR17YC	SUPER	DR17YS	SILVER
402500, 407500, 407600 / V2 OHV		DR17YC	SUPER	DR17YS	SILVER
ELS - 125300 ELS, ELS - 125400		DR17YC	SUPER	DR17YS	SILVER
ELS - 28AH00, ELS - 28BH00, ELS - 28CH00		DR17YC	SUPER	DR17YS	SILVER
ELS - 31J700, ELS - 31K700		DR17YC	SUPER	DR17YS	SILVER
ELS - 31L700, ELS - 31M700		DR17YC	SUPER	DR17YS	SILVER
ELS - 40F700, ELS - 40G700, ELS - 40H700		DR17YC	SUPER	DR17YS	SILVER
ELS - 446600, ELS - 446700		DR17YC	SUPER	DR17YS	SILVER
ELS - 446800, ELS - 446900		DR17YC	SUPER	DR17YS	SILVER
110400, 111400, 113400 / Intek V1 OHV		DR17YC	SUPER	DR17YS	SILVER
110600, 111600, 11C600 / Intek V1 OHV	0,5	DR17YC	SUPER	DR17YS	SILVER
120400, 121A00, 121300, 121400 / Intek V1 OHV		DR17YC	SUPER	DR17YS	SILVER
120600, 121600, 122600, 125600 / Intek V1 OHV	0,5	DR17YC	SUPER	DR17YS	SILVER
123300, 123400, 123600, 124600 / Intek V1 OHV		DR17YC	SUPER	DR17YS	SILVER
126600, 127400, 127600, 128600 / Intek V1 OHV	0,5	DR17YC	SUPER	DR17YS	SILVER
127300, 128300, 128400, 129400 / Intek V1 OHV		DR17YC	SUPER	DR17YS	SILVER
129600, 12A600, 12B600, 12C600 / Intek V1 OHV	0,5	DR17YC	SUPER	DR17YS	SILVER
12A300, 12A400, 12B300, 12B400 / Intek V1 OHV		DR17YC	SUPER	DR17YS	SILVER
12C300, 12C400, 12D300, 12D400 / Intek V1 OHV		DR17YC	SUPER	DR17YS	SILVER
12D600, 12F600, 12G600, 12H600 / Intek V1 OHV	0,5	DR17YC	SUPER	DR17YS	SILVER
12E300, 15A100, 15B100 / Intek V1 OHV		DR17YC	SUPER	DR17YS	SILVER
12Z600 / Intek V1 OHV	0,5	DR17YC	SUPER	DR17YS	SILVER
201400, 202400, 203400, 204400 / Intek V1 OHV		DR17YC	SUPER	DR17YS	SILVER
205400, 206400 / Intek V1 OHV		DR17YC	SUPER	DR17YS	SILVER
20A100, 20A400 / Intek V1 OHV		DR17YC	SUPER	DR17YS	SILVER
20B400, 20C400, 20D400, 20E100 / Intek V1 OHV		DR17YC	SUPER	DR17YS	SILVER
20E200, 20E300, 20E400 / Intek V1 OHV		DR17YC	SUPER	DR17YS	SILVER
20F400, 20G400 / Intek V1 OHV		DR17YC	SUPER	DR17YS	SILVER



STANDARD
BRISK

ALTERNATIVE
BRISK

BRIGGS & STRATTON

ELEKTROCENTRÁLY / STACIONÁRNÍ MOTORY • ELEKTROCENTRALS / STATIONARY ENGINES • ЭЛЕКТРИЧЕСКИЕ КОММУТАТОРЫ / СТАЦИОНАРНЫЕ ДВИГАТЕЛИ

210700, 212900, 213400, 214900	/ Intek V1 OHV	DR17YC	SUPER	DR17YS	SILVER
215900, 216900, 217900, 218700	/ Intek V1 OHV	DR17YC	SUPER	DR17YS	SILVER
219900	/ Intek V1 OHV	DR17YC	SUPER	DR17YS	SILVER
21A400, 21A700, 21B900	/ Intek V1 OHV	DR17YC	SUPER	DR17YS	SILVER
283H00, 284H00, 285H00, 286H00	/ Intek V1 OHV	DR17YC	SUPER	DR17YS	SILVER
310700, 311700, 312700, 314700	/ Intek V1 OHV	DR17YC	SUPER	DR17YS	SILVER
31E700, 31F700, 31H700	/ Intek V1 OHV	DR17YC	SUPER	DR17YS	SILVER
405700, 406500	/ Intek V-Twin OHV	DR17YC	SUPER	DR17YS	SILVER
406700, 407700	/ Intek V-Twin OHV	DR17YC	SUPER	DR17YS	SILVER
445700	/ Intek V-Twin OHV	DR17YC	SUPER	DR17YS	SILVER
400400, 400700, 401400, 401700	/ Opposed V-Twin "L"	JR19	CLASSIC		
402400, 402700, 404400, 404700	/ Opposed V-Twin "L"	JR19	CLASSIC		
421400, 421700, 422400, 422700	/ Opposed V-Twin "L"	JR19	CLASSIC		
42A700, 42B700, 42C700, 42D700	/ Opposed V-Twin "L"	JR19	CLASSIC		
42E700, 460700, 461700, 462700	/ Opposed V-Twin "L"	JR19	CLASSIC		
463700, 48A700	/ Opposed V-Twin "L"	JR19	CLASSIC		
100200, 100600, 100700, 100900	/V1 "L"	JR19	CLASSIC		
104700, 10A900, 10B900, 10C900	/V1 "L"	JR19	CLASSIC		
10D900, 10E900, 10F900, 10G900	/V1 "L"	JR19	CLASSIC		
10L900, 10M900, 110000, 110700	/V1 "L"	JR19	CLASSIC		
111000, 111700, 111900, 112000	/V1 "L"	JR19	CLASSIC		
113000, 114000, 120H00, 121000	/V1 "L"	JR19	CLASSIC		
120J00, 121800, 121H00, 121K00	/V1 "L"	JR19	CLASSIC		
122700, 122800, 122H00, 122K00	/V1 "L"	JR19	CLASSIC		
123000, 123700, 123H00, 123J00	/V1 "L"	JR19	CLASSIC		
123K00, 124000, 124H00, 124K00	/V1 "L"	JR19	CLASSIC		
125000, 125H00, 125K00, 126000	/V1 "L"	JR19	CLASSIC		
126H00, 127700, 127800, 128700	/V1 "L"	JR19	CLASSIC		
128800, 128H00, 129700, 129800	/V1 "L"	JR19	CLASSIC		
129H00, 12A800, 12B000	/V1 "L"	JR19	CLASSIC		
12B700, 12B800, 12C000, 12C700	/V1 "L"	JR19	CLASSIC		
12C800, 12D800, 12E700, 12E800	/V1 "L"	JR19	CLASSIC		
12F700, 12F800, 12G700, 12G800	/V1 "L"	JR19	CLASSIC		
12H700, 12H800, 12J700, 12J800	/V1 "L"	JR19	CLASSIC		
12K800, 12L700, 12M800, 12N800	/V1 "L"	JR19	CLASSIC		
12P800, 12Q800, 12R800, 12S700	/V1 "L"	JR19	CLASSIC		
12S800, 12T700, 12T800, 12U800	/V1 "L"	JR19	CLASSIC		
12V800, 12W800, 12X800, 130000	/V1 "L"	JR19	CLASSIC		
131000, 132000, 133200, 133400	/V1 "L"	JR19	CLASSIC		
133700, 134200, 134400, 135200	/V1 "L"	JR19	CLASSIC		
135400, 135700, 136200, 137000	/V1 "L"	JR19	CLASSIC		
137200, 142300, 142400, 142700	/V1 "L"	JR19	CLASSIC		
170400, 170700, 171400, 171700	/V1 "L"	JR19	CLASSIC		
176400, 190400, 190700, 191700	/V1 "L"	JR19	CLASSIC		
192400, 192700, 193400, 193700	/V1 "L"	JR19	CLASSIC		
194400, 194700, 195400, 195700	/V1 "L"	JR19	CLASSIC		
196400, 196700, 197400, 197700	/V1 "L"	JR19	CLASSIC		
198700, 19K400, 200400, 220400	/V1 "L"	JR19	CLASSIC		
19A400, 19B400, 19C400	/V1 "L"	DR17YC	SUPER	DR17YS	SILVER
19E400, 19F400, 19G400	/V1 "L"	DR17YC	SUPER	DR17YS	SILVER
21000, 21100	/V1 "L"	UR17Y	CLASSIC		
220700, 221400, 222400, 226400	/V1 "L"	JR19	CLASSIC		
231400, 233400, 243400, 250400	/V1 "L"	JR19	CLASSIC		
251400, 251700, 252000, 253000	/V1 "L"	JR19	CLASSIC		
254400, 254700, 255400, 255700	/V1 "L"	JR19	CLASSIC		
256400, 256700, 257400, 257700	/V1 "L"	JR19	CLASSIC		



service
instructions

... BOSCH
... CHAMPION ...
... NGK ...



BRISK

LAST INFO



**STANDARD
BRISK**

**ALTERNATIVE
BRISK**

BRIGGS & STRATTON

ELEKTROCENTRÁLY / STACIONÁRNÍ MOTORY - ELEKTROCENTRALS / STATIONARY ENGINES - ЭЛЕКТРИЧЕСКИЕ КОММУТАТОРЫ / СТАЦИОНАРНЫЕ ДВИГАТЕЛИ

257700, 258700, 259700, 259700	/V1 "L"		JR19	CLASSIC		
280700, 281700, 282700, 283700	/V1 "L"		JR19	CLASSIC		
284700, 285700, 286700, 288700	/V1 "L"		JR19	CLASSIC		
289700, 28A700, 28B700, 28C700	/V1 "L"		JR19	CLASSIC		
28D700, 28F700, 28M700, 28R700	/V1 "L"		JR19	CLASSIC		
28T700, 28V700, 300400, 301400	/V1 "L"		JR19	CLASSIC		
302400, 320400, 325400, 326400	/V1 "L"		JR19	CLASSIC		
60100, 80100, 80200, 80300	/V1 "L"		JR19	CLASSIC		
80400, 82200, 82300, 82400	/V1 "L"		JR19	CLASSIC		
82500, 82900, 83400, 84500	/V1 "L"		JR19	CLASSIC		
84700, 84900, 85500, 85900	/V1 "L"		JR19	CLASSIC		
90100, 90200, 90400, 90700	/V1 "L"		JR19	CLASSIC		
91200, 91400, 91700, 92200	/V1 "L"		JR19	CLASSIC		
92400, 92500, 92900, 93200	/V1 "L"		JR19	CLASSIC		
93400, 94200, 9K400	/V1 "L"		DR17YC	SUPER	DR17YS	SILVER
93440, 93500, 93900, 94500	/V1 "L"		JR19	CLASSIC		
94900, 95200, 95500, 95700	/V1 "L"		JR19	CLASSIC		
95900, 96500, 96700, 96900	/V1 "L"		JR19	CLASSIC		
98900, 9B900, 9C900, 9D900	/V1 "L"		JR19	CLASSIC		
9E900, 9F900, 9G900, 9H900	/V1 "L"		JR19	CLASSIC		
9J900, 9K900	/V1 "L"		JR19	CLASSIC		
11A600, 11B600	/V1 OHV	0,5	DR17YC	SUPER	DR17YS	SILVER
120300, 126300	/V1 OHV		DR17YC	SUPER	DR17YS	SILVER
126400, 12Y600, 12Y800, 12Z800	/V1 OHV		DR17YC	SUPER	DR17YS	SILVER
207400, 210400, 210700, 210800	/V1 OHV		DR17YC	SUPER	DR17YS	SILVER
211700, 211800, 212400, 212700	/V1 OHV		DR17YC	SUPER	DR17YS	SILVER
212800, 213700, 213800, 214700	/V1 OHV		DR17YC	SUPER	DR17YS	SILVER
214800, 215700, 215800, 216700	/V1 OHV		DR17YC	SUPER	DR17YS	SILVER
216800, 217700, 217800, 218700	/V1 OHV		DR17YC	SUPER	DR17YS	SILVER
218800, 219700, 219800, 21A800	/V1 OHV		DR17YC	SUPER	DR17YS	SILVER
21A900, 21B700, 21B800, 21C100	/V1 OHV		DR17YC	SUPER	DR17YS	SILVER
21C200, 280H00, 281H00, 282H00	/V1 OHV		DR17YC	SUPER	DR17YS	SILVER
287700, 28E700, 28N700, 28U700	/V1 OHV		DR17YC	SUPER	DR17YS	SILVER
28W700, 313700, 319700, 31A700	/V1 OHV		DR17YC	SUPER	DR17YS	SILVER
31B700, 31C700, 31D700, 31G700	/V1 OHV		DR17YC	SUPER	DR17YS	SILVER
50000, 97700, 99700	/V1 OHV		DR17YC	SUPER	DR17YS	SILVER
104700, 115400, 117400, 138400	/V1 Vanguard OHV		DR17YC	SUPER	DR17YS	SILVER
118400, 5000	/V1 Vanguard OHV		NR15YC	SUPER		
161400, 185400, 186400, 235400	/V1 Vanguard OHV		DR17YC	SUPER	DR17YS	SILVER
245400, 260700, 261700, 28P700	/V1 Vanguard OHV		DR17YC	SUPER	DR17YS	SILVER
28Q700, 28S700, 312700	/V1 Vanguard OHV		DR17YC	SUPER	DR17YS	SILVER
85400, 86400	/V1 Vanguard OHV		DR17YC	SUPER	DR17YS	SILVER
290400, 290700, 294400, 294700	/V-Twin Vanguard OHC		DR17YC	SUPER	DR17YS	SILVER
303400, 303700, 304400, 305700	/V-Twin Vanguard OHC		DR17YC	SUPER	DR17YS	SILVER
30A400, 350400, 350700, 351400	/V-Twin Vanguard OHC		DR17YC	SUPER	DR17YS	SILVER
351700, 354400, 355700, 356400	/V-Twin Vanguard OHC		DR17YC	SUPER	DR17YS	SILVER
356700, 357700, 358700, 380400	/V-Twin Vanguard OHC		DR17YC	SUPER	DR17YS	SILVER
380700, 381400, 381700, 385400	/V-Twin Vanguard OHC		DR17YC	SUPER	DR17YS	SILVER
385700, 386400, 386700, 474100	/V-Twin Vanguard OHC		DR17YC	SUPER	DR17YS	SILVER
541400, 543400, 613100	/V-Twin Vanguard OHC		DR17YC	SUPER	DR17YS	SILVER
542400, 543200, 613100, 613400	/V-Twin Vanguard OHC	0,5	DR17YC	SUPER	DR17YS	SILVER
430400 (DM700G), 431400, 432400	/V3 Vanguard		DR17YC	SUPER	DR17YS	SILVER
433400, 434400, 435400, 436400	/V3 Vanguard		DR17YC	SUPER	DR17YS	SILVER
437400, 473100, 522400	/V3 Vanguard		DR17YC	SUPER	DR17YS	SILVER
580400 (DM950G), 581400, 582400	/V3 Vanguard		DR17YC	SUPER	DR17YS	SILVER
583400, 584400, 585400, 586400	/V3 Vanguard		DR17YC	SUPER	DR17YS	SILVER



STANDARD
BRISK

ALTERNATIVE
BRISK

BRIGGS & STRATTON

ELEKTROCENTRÁLY / STACIONÁRNÍ MOTORY • ELEKTROCENTRALS / STATIONARY ENGINES • ЭЛЕКТРИЧЕСКИЕ КОММУТАТОРЫ / СТАЦИОНАРНЫЕ ДВИГАТЕЛИ

587400, 588400, 589400, 58A400	/V3 Vanguard	DR17YC	SUPER	DR17YS	SILVER
613400	/V3 Vanguard	DR17YC	SUPER	DR17YS	SILVER
MOTOROVÉ TRAVNÍ SEKAČKY • LAWN MOWER • СЕНОКОСИЛКИ					
2 HP	- 60000, 60100	JR19	CLASSIC		
2,5 HP	- 80100	JR19	CLASSIC		
3 HP	- 62000	JR19	CLASSIC		
3 HP	- 80000, 90100, 90200	JR19	CLASSIC		
3 HP	- 92500, 94500	JR19	CLASSIC		
3,5 HP	- 90000, 90700, 91000, 91200, 91700	JR19	CLASSIC		
3,5 HP	- 92000, 92200, 92900, 93200, 93900	JR19	CLASSIC		
3,5 HP	- 93440, 94900, 95900, 96500	JR19	CLASSIC		
3,5 HP	- 100000, 100700, 121000, 128000	JR19	CLASSIC		
3,5 HP	- 93400	DR17YC	SUPER	DR17YS	SILVER
3,75 HP	- 96900, 98900	JR19	CLASSIC		
3,8 HP	- 9C900, 9D900	JR19	CLASSIC		
4 HP	- 10A900, 10B900, 100200, 100900	JR19	CLASSIC		
4 HP	- 100202	JR19	CLASSIC		
4 HP	- 110000, 110700, 110900	JR19	CLASSIC		
4 HP	- 111000, 112000, 113000	JR19	CLASSIC		
4 HP	- 114000, 12E000, 12T000, 122000	JR19	CLASSIC		
4 HP	- 123000	JR19	CLASSIC		
4 HP	- 854400 (OHV - Vanguard)	DR17YC	SUPER	DR17YS	SILVER
4 HP	- 95000, 96000	JR19	CLASSIC		
4,5 HP	- 104000 (OHV)	DR17YC	SUPER	DR17YS	SILVER
4,5 HP	- 12L000	JR19	CLASSIC		
4,75 HP	- 12A000, 12D000	JR19	CLASSIC		
5 HP	- OHV, 104700 (OHV - Vanguard)	DR17YC	SUPER	DR17YS	SILVER
5 HP	- 12F000, 12G000, 12U000, 124000	JR19	CLASSIC		
5 HP	- 124700	JR19	CLASSIC		
5 HP	- 125000, 126000, 130000, 131000	JR19	CLASSIC		
5 HP	- 132000, 133200, 133400	JR19	CLASSIC		
5 HP	- 135200, 136200	JR19	CLASSIC		
5 HP	- 95700, 96700	JR19	CLASSIC		
5,25 HP	- 12B000, 12C000	JR19	CLASSIC		
5,5 HP	- 12M000, 129000, 134400, 137000	JR19	CLASSIC		
5,5 HP	- 115400 (OHV - Vanguard)	DR17YC	SUPER	DR17YS	SILVER
5,5 HP	- OHV	DR17YC	SUPER	DR17YS	SILVER
5,5 HP	- 110400, 111400, 113400 / OHV Intek	DR17YC	SUPER	DR17YS	SILVER
6 HP	- 12H000, 12J000, 12V000, 12W000	JR19	CLASSIC		
6 HP	- 133700, 135700	JR19	CLASSIC		
6 HP	- 146400, 146700	JR19	CLASSIC		
6 HP	- 97700, 99700, 117400 / OHV / Vanguard	DR17YC	SUPER	DR17YS	SILVER
6,5 HP	- 110600, 111600 / OHV Intek	DR17YC	SUPER	DR17YS	SILVER
6,5 HP	- 120600, 121600, 122600 / OHV Intek	DR17YC	SUPER	DR17YS	SILVER
6,5 HP	- 120400, 121400, 123400 / OHV Intek	DR17YC	SUPER	DR17YS	SILVER
6,5 HP	- 170700	JR19	CLASSIC		
7 HP	- 170400, 171400, 17U000, 176400	JR19	CLASSIC		
7,5 HP	- 138400 (OHV - Vanguard)	DR17YC	SUPER	DR17YS	SILVER
8 HP	- 190000	JR19	CLASSIC		
8 HP	- 190400, 190700, 191700, 192400	JR19	CLASSIC		
8 HP	- 193700, 194000, 195000, 196400	JR19	CLASSIC		
8 HP	- 197400, 200400	JR19	CLASSIC		
8,5 HP	- 160000 (OHV)	DR17YC	SUPER	DR17YS	SILVER
8,5 HP	- 196700	JR19	CLASSIC		
9 HP	- 19A400, 19B400, 19C400	DR17YC	SUPER	DR17YS	SILVER
9 HP	- 161400, 185400 / OHV - Vanguard	DR17YC	SUPER	DR17YS	SILVER



service
instructions

... BOSCH ...
... CHAMPION ...
... NGK ...



BRISK

LAST INFO

**STANDARD
BRISK**
**ALTERNATIVE
BRISK**
BRIGGS & STRATTON
MOTOROVÉ TRAVNÍ SEKAČKY • LAWN MOWER • СЕНОКОСИЛКИ

9 HP - 230000, 231400, 233400		JR19	CLASSIC		
10 HP - 19E400, 19F400, 19G400		DR17YC	SUPER	DR17YS	SILVER
10 HP - 220000, 221400		JR19	CLASSIC		
10 HP - 222400, 226400, 240000, 243400		JR19	CLASSIC		
10 HP - 254700, 255700, 256700, 28A700		JR19	CLASSIC		
10,5 HP - 257700, 28B700		JR19	CLASSIC		
11 HP - 235400 (OHV - Vanguard)		DR17YC	SUPER	DR17YS	SILVER
11 HP - 250000		JR19	CLASSIC		
11 HP - 250400, 251400, 251700, 252000		JR19	CLASSIC		
11 HP - 253000, 254400, 255400, 256400		JR19	CLASSIC		
11 HP - 258700, 259700, 28C700		JR19	CLASSIC		
11,5 HP - 259700, 28D700		JR19	CLASSIC		
12 HP - 280000		JR19	CLASSIC		
12 HP - 280700, 281700, 282700, 283700		JR19	CLASSIC		
12 HP - 284700, 300400, 301400		JR19	CLASSIC		
12,5 HP - 260000, 260700 / OHV - Vanguard		DR17YC	SUPER	DR17YS	SILVER
12,5 HP - 285700, 286700, 288700, 289700		JR19	CLASSIC		
12,5 HP - 290000 (OHV)		DR17YC	SUPER	DR17YS	SILVER
12,5 HP - 290400, 290700 / OHV - Vanguard		DR17YC	SUPER	DR17YS	SILVER
12,5 HP - 404400xx	0,8	K17C	SUPER		
12,5 HP - 404400, 404700		JR19	CLASSIC		
13 HP - 245400 (OHV - Vanguard)		DR17YC	SUPER	DR17YS	SILVER
13 HP - 28F700, 28M700		JR19	CLASSIC		
13 HP - 302400, 302430		JR19	CLASSIC		
13,5 HP - 28R700		JR19	CLASSIC		
14 HP - 261700 / OHV / Vanguard		DR17YC	SUPER	DR17YS	SILVER
14 HP - 28E700, 28P700 / OHV - Vanguard		DR17YC	SUPER	DR17YS	SILVER
14 HP - 294400, 294700 / OHV / Vanguard		DR17YC	SUPER	DR17YS	SILVER
14 HP - 320400, 400400, 400700		JR19	CLASSIC		
14 HP - 400000xx	0,8	K17C	SUPER		
14,5 HP - 287700 (OHV)		DR17YC	SUPER	DR17YS	SILVER
15 HP - 300000 (OHV)		DR17YC	SUPER	DR17YS	SILVER
15 HP - 325400		JR19	CLASSIC		
15,5 HP - 28N700, 28S700 / OHV - Vanguard		DR17YC	SUPER	DR17YS	SILVER
16 HP - 28Q700, 28U700 / OHV - Vanguard		DR17YC	SUPER	DR17YS	SILVER
16 HP - 303400, 303700 / OHV - Vanguard		DR17YC	SUPER	DR17YS	SILVER
16 HP - 320000		JR19	CLASSIC		
16 HP - 326400, 401400, 401700, 402400		JR19	CLASSIC		
16 HP - 402000xx	0,8	K17C	SUPER		
16 HP - 402700, 42B700		JR19	CLASSIC		
16,5 HP - 28W700, 310700 / OHV / Intek		DR17YC	SUPER	DR17YS	SILVER
16,5 HP - 40A700		JR19	CLASSIC		
17 HP - 310700, 312700 / OHV Intek		DR17YC	SUPER	DR17YS	SILVER
17 HP - 42C700		JR19	CLASSIC		
18 HP - 10000 V-Twin Vanguard		DR17YC	SUPER	DR17YS	SILVER
18 HP - 350400, 350700 / V-Twin OHV Vanguard		DR17YC	SUPER	DR17YS	SILVER
18 HP - 405700 (V-Twin OHV Intek)		DR17YC	SUPER	DR17YS	SILVER
18 HP - 422000xx (V-Twin)	0,8	K17C	SUPER		
18 HP - 421400, 421700, 422400, 422700		JR19	CLASSIC		
18,5 HP - 42D700		JR19	CLASSIC		
19,5 HP - 42E700		JR19	CLASSIC		
20 HP - 351400, 351700 / V-Twin OHV Vanguard		DR17YC	SUPER	DR17YS	SILVER
20 HP - 460700xx		JR19	CLASSIC		
20 HP - 406700 (V-Twin OHV Intek)		DR17YC	SUPER	DR17YS	SILVER
20,5 HP - 461700		JR19	CLASSIC		
21 HP - 381400, 381700 / V-Twin OHV Vanguard		DR17YC	SUPER	DR17YS	SILVER



STANDARD
BRISK

ALTERNATIVE
BRISK

BRIGGS & STRATTON

MOTOROVÉ TRAVNÍ SEKAČKY • LAWN MOWER • СЕНОКОСИЛКИ

22 HP - 407700 (V-Twin OHV Intek)	DR17YC	SUPER	DR17YS	SILVER
23 HP - 380400, 380700 / V-Twin OHV Vanguard	DR17YC	SUPER	DR17YS	SILVER
23,5 HP - 430400 (DM700G)	DR17YC	SUPER	DR17YS	SILVER
25 HP - 445700 (V-Twin OHV Intek)	DR17YC	SUPER	DR17YS	SILVER
31 HP - 580400 (DM950G)	DR17YC	SUPER	DR17YS	SILVER
BSQ 1000	N15YC	SUPER		
Classic	JR19	CLASSIC		
Diamond XTL	JR19	CLASSIC		
ES 375	JR19	CLASSIC		
Europa 99772 OHV	DR17YC	SUPER	DR17YS	SILVER
Intek OHV	DR17YC	SUPER	DR17YS	SILVER
11 H	DR17YC	SUPER	DR17YS	SILVER
12 H	DR17YC	SUPER	DR17YS	SILVER
12 V	DR17YC	SUPER	DR17YS	SILVER
20 H	DR17YC	SUPER	DR17YS	SILVER
28	DR17YC	SUPER	DR17YS	SILVER
31	DR17YC	SUPER	DR17YS	SILVER
40	DR17YC	SUPER	DR17YS	SILVER
44	DR17YC	SUPER	DR17YS	SILVER
Quantum	JR19	CLASSIC		
Quattro	JR19	CLASSIC		
Sprint	JR19	CLASSIC		
Vanguard	DR17YC	SUPER	DR17YS	SILVER

CAMPBELL-HAUSFELD

MOTOROVÉ PÍLY • CHAINSAW • МОТОПИЛЫ

2000	U17	CLASSIC		
3000, 3001, 3002, 3003	U17	CLASSIC		

CANADIANA

MALOTRAKTORY • TRACTORS • МАЛОГАБАРИТНЫЕ ТРАКТОРЫ

All models	0,8	K19	CLASSIC	
------------	-----	-----	---------	--

MOTOROVÉ TRAVNÍ SEKAČKY • LAWN MOWER • СЕНОКОСИЛКИ

All models	0,8	K19	CLASSIC	
------------	-----	-----	---------	--

CASAL

ELEKTROCENTRÁLY / STACIONÁRNÍ MOTORY • ELEKTROCENTRALS / STATIONARY ENGINES • ЭЛЕКТРИЧЕСКИЕ КОММУТАТОРЫ / СТАЦИОНАРНЫЕ ДВИГАТЕЛИ

M 136, M 140, M 147, M 148	0,5	N17C	SUPER	
M 149, M 196, M 197	0,5	N17C	SUPER	
M 131, M 132, M 137	0,5	N15C	SUPER	NR15S SILVER
M 151, M 152, M 153	0,5	N15C	SUPER	NR15S SILVER
M 233	0,5	L14C	SUPER	LR14S SILVER

MOTOROVÉ TRAVNÍ SEKAČKY • LAWN MOWER • СЕНОКОСИЛКИ

M 132 (50ccm)	0,5	N15C	SUPER	NR15S SILVER
---------------	-----	------	-------	--------------

CASE

KULTIVÁTORY • CULTIVATORS • КУЛЬТИВАТОРЫ

B & S	JR19	CLASSIC		
Kohler - 7 HP	JR19	CLASSIC		
Onan NHC	L17C	SUPER		
Tecumseh - 7 HP, 10 HP, 12 HP	0,8	K19	CLASSIC	

MALOTRAKTORY • TRACTORS • МАЛОГАБАРИТНЫЕ ТРАКТОРЫ

77 (Gas)	L15C ^{+R}	SUPER		
80 (Gas)	L15C ^{+R}	SUPER		
88 (Gas)	L15C ^{+R}	SUPER		
130, 133, 135, 140, 160, 177, 200, 220	L15C ^{+R}	SUPER		
230, 330T, 330W	L15C ^{+R}	SUPER		
200	L15C ^{+R}	SUPER		
600 (Case - GAS)	L15C ^{+R}	SUPER		
Windrower - 650	L15C ^{+R}	SUPER		



service
instructions

... BOSCH ...
... CHAMPION ...
... NGK ...



cross reference

BRISK

LAST INFO

**STANDARD
BRISK**
**ALTERNATIVE
BRISK**
CASE
MALOTRAKTORY • TRACTORS • МАЛОГАБАРИТНЫЕ ТРАКТОРЫ

Windrower - 655		L15C ^{+R}	SUPER		
660 (Case - GAS)		L15C ^{+R}	SUPER		
700 (Chrysler - H225 - GAS)	0,6	L15C	SUPER	LR15S	SILVER
800 (Case - LPG)		L15C ^{+R}	SUPER		
820		L15C ^{+R}	SUPER		
855		L15C ^{+R}	SUPER		
900 (Chrysler - H225 - GAS)	0,6	L15C	SUPER	LR15S	SILVER
950		L15C ^{+R}	SUPER		
960 (Chrysler - H225 - GAS)	0,6	L15C	SUPER	LR15S	SILVER
1000 (Case - LPG)		L15C ^{+R}	SUPER		
1000 (Case - GAS)		L15C ^{+R}	SUPER		
1000 (Hercules - GAS)		K17C	SUPER		
1010 (Chrysler - HB308 - GAS)	0,6	L17YC	SUPER	LR17YS	SILVER
1010 (Case - GAS)		L15C ^{+R}	SUPER		
1010 (Chrysler - HB308/X - GAS)	0,6	JR17	CLASSIC		
1010 (Case - LPG)		L15C ^{+R}	SUPER		
1050		L15C ^{+R}	SUPER		
1060 (Case - LPG)		L15C ^{+R}	SUPER		
1060 (Case - LPG - 284 cu.in.)		L15C ^{+R}	SUPER		
1060 (Chrysler - HB308 - GAS)	0,6	L17YC	SUPER	LR17YS	SILVER
1060 (Chrysler - HB308/X - GAS)	0,6	JR17	CLASSIC		
1140		L15C ^{+R}	SUPER		
1150		L15C ^{+R}	SUPER		
1155		L15C ^{+R}	SUPER		
1665 (Chrysler - HB308/X - GAS)	0,6	JR17	CLASSIC		
C2		L15C ^{+R}	SUPER		
MT		L15C ^{+R}	SUPER		
NAP - 2, NAP - 3		K17C	SUPER		
NC, NCM, NL, NT		L15C ^{+R}	SUPER		
GAS - Tractor - 430, 431, 435, 440, 441		L15C ^{+R}	SUPER		
GAS - Tractor - 445, 470, 530, 531, 535		L15C ^{+R}	SUPER		
GAS - Tractor - 540, 541, 545, 570, 610		L15C ^{+R}	SUPER		
GAS - Tractor - 730, 731, 732, 733, 734		L15C ^{+R}	SUPER		
GAS - Tractor - 740, 741, 742, 743, 744		L15C ^{+R}	SUPER		
GAS - Tractor - 770, 830, 831, 832, 833		L15C ^{+R}	SUPER		
GAS - Tractor - 840, 841, 843, 870, 901		L15C ^{+R}	SUPER		
GAS - Tractor - 930, 970		L15C ^{+R}	SUPER		
LPG - Tractor - 430, 530, 630, 730, 731		L15C ^{+R}	SUPER		
LPG - Tractor - 732, 733, 734, 740, 741		L15C ^{+R}	SUPER		
LPG - Tractor - 742, 743, 744, 830, 831		L15C ^{+R}	SUPER		
LPG - Tractor - 832, 833, 840, 841, 842		L15C ^{+R}	SUPER		
LPG - Tractor - 843, 930		L15C ^{+R}	SUPER		

MOTOROVÉ TRAVNÍ SEKAČKY • LAWN MOWER • СЕНОКОСИЛКИ

All models	0,8	P17	CLASSIC		
------------	-----	-----	---------	--	--

CASTOR
MOTOROVÉ PILY • CHAINSAW • МОТОПИЛЫ

330, 380		P17Y	CLASSIC	PR17YC	SUPER
C 35, C 40, C 40E, C 70, C 70S, C 90	0,5	PR15Y	CLASSIC	PR17YC	SUPER
CP 41		P17Y	CLASSIC	PR17YC	SUPER
CP 45, CP 55, CP 65, CP 90, CP 120	0,5	PR15Y	CLASSIC	PR17YC	SUPER
Tropical 120	0,5	PR15Y	CLASSIC	PR17YC	SUPER

CATERPILLAR
ELEKTROCENTRÁLY / STACIONÁRNÍ MOTORY • ELEKTROCENTRALS / STATIONARY ENGINES • ЭЛЕКТРИЧЕСКИЕ КОММУТАТОРЫ / СТАЦИОНАРНЫЕ ДВИГАТЕЛИ

12, 14, 16, 30, 42, 44		K17Y	CLASSIC		
12F, 14C, 112E, 561B, 619C		K15YC	SUPER		
48, 66, 77, 112, 212, 666		K17Y	CLASSIC		



CATERPILLAR

ELEKTROCENTRÁLY / STACIONÁRNÍ MOTORY • ELEKTROCENTRALS / STATIONARY ENGINES • ЭЛЕКТРИЧЕСКИЕ КОММУТАТОРЫ / СТАЦИОНАРНЫЕ ДВИГАТЕЛИ

621, 630, 631, 633, 641		K17Y	CLASSIC		
650, 651, 657, 660		K17Y	CLASSIC		
922, 944, 950, 955		K15YC	SUPER		
D 311, D 315, D 318, D 320, D 326, D 327		K17Y	CLASSIC		
D 330, D 333		K15YC	SUPER		
D 339, D 342, D 343, D 353, D 375, D 379	0,8	K17Y	CLASSIC		
D 397, D 398, D 3400, D 4400, D 4600	0,8	K17Y	CLASSIC		
D 6600, D 7700, D 8800, D 11000	0,8	K17Y	CLASSIC		
D 13000, D 17000	0,8	K17Y	CLASSIC		

C-B TOOL CO.

MOTOROVÉ PÍLY • CHAINSAW • МОТОПИЛЫ

50006, 50010 / (Chrysler)		P17	CLASSIC		
---------------------------	--	-----	---------	--	--

CIFARELLI

ELEKTROCENTRÁLY / STACIONÁRNÍ MOTORY • ELEKTROCENTRALS / STATIONARY ENGINES • ЭЛЕКТРИЧЕСКИЕ КОММУТАТОРЫ / СТАЦИОНАРНЫЕ ДВИГАТЕЛИ

C 3	0,5	PR15Y	CLASSIC	PR17YC	SUPER
C 7	0,5	PR15Y	CLASSIC	PR17YC	SUPER
L-80 Nuvola	0,5	PR15Y	CLASSIC	PR17YC	SUPER

CLARKE

ELEKTROCENTRÁLY / STACIONÁRNÍ MOTORY • ELEKTROCENTRALS / STATIONARY ENGINES • ЭЛЕКТРИЧЕСКИЕ КОММУТАТОРЫ / СТАЦИОНАРНЫЕ ДВИГАТЕЛИ

B & S - 5 HP	0,6	J19	CLASSIC		
Robin - 7,8 HP	0,5	N19C	SUPER		
B & S - 8 HP	0,6	J19	CLASSIC		
Honda - 8 HP		L17YC	SUPER	LR17YS	SILVER
B & S - 11 HP	0,6	J19	CLASSIC		

CLEVELAND

MALOTRAKTORY • TRACTORS • МАЛОГАБАРИТНЫЕ ТРАКТОРЫ

J 20, J 30, J 36, J 40		K17C	SUPER		
JS 20, JS 30, JS 36, JS 40		K17C	SUPER		

CLINTON

ELEKTROCENTRÁLY / STACIONÁRNÍ MOTORY • ELEKTROCENTRALS / STATIONARY ENGINES • ЭЛЕКТРИЧЕСКИЕ КОММУТАТОРЫ / СТАЦИОНАРНЫЕ ДВИГАТЕЛИ

412, 413, 492, 494, 498, 499	0,6	J17	CLASSIC		
502, 503		K15YC	SUPER		
A 300, A 1200	0,6	J17	CLASSIC		
C 700	0,6	J17	CLASSIC		
D 700	0,6	J17	CLASSIC		
E 65, E 1290	0,6	J17	CLASSIC		
V 1000, V 1100, V 1200	0,6	J17	CLASSIC		
VS 300, VS 900, VS 1100, VS 1200	0,6	J17	CLASSIC		

MOTOROVÉ PÍLY • CHAINSAW • МОТОПИЛЫ

D 15, D 25		P17	CLASSIC		
D 35, D 55, D 65		K19	CLASSIC		
E 10		P15	CLASSIC		
E 75, E 95		P17	CLASSIC		

MOTOROVÉ TRAVNÍ SEKAČKY • LAWN MOWER • СЕНОКОСИЛКИ

Chieftan	0,8	K15YC	SUPER		
----------	-----	-------	-------	--	--

COLEMAN

ELEKTROCENTRÁLY / STACIONÁRNÍ MOTORY • ELEKTROCENTRALS / STATIONARY ENGINES • ЭЛЕКТРИЧЕСКИЕ КОММУТАТОРЫ / СТАЦИОНАРНЫЕ ДВИГАТЕЛИ

2 HP Robin		P15Y	CLASSIC	PR17YC	SUPER
3,1 HP Kawasaki (all models)	0,5	P17	CLASSIC		
3,5 HP B & S	0,5	JR19	CLASSIC		
3,5 HP B & S Intek		DR17YC	SUPER	DR17YS	SILVER
5,5 HP B & S	0,5	JR19	CLASSIC		
5,5 HP Honda (all models)	0,6	L17YC	SUPER	LR17YS	SILVER
6 HP B & S Intek (OHV - PM 5300)		DR17YC	SUPER	DR17YS	SILVER
10 HP 5000	0,5	JR19	CLASSIC		
10 HP B & S		DR17YC	SUPER	DR17YS	SILVER



service
instructions

... BOSCH ...
... CHAMPION ...
... NGK ...



LAST INFO



STANDARD
BRISK

ALTERNATIVE
BRISK

COLEMAN

ELEKTROCENTRÁLY / STACIONÁRNÍ MOTORY • ELEKTROCENTRALS / STATIONARY ENGINES • ЭЛЕКТРИЧЕСКИЕ КОММУТАТОРЫ / СТАЦИОНАРНЫЕ ДВИГАТЕЛИ

10 HP B & S Gen Power (OHV)		K17C	SUPER		
10 HP Tecumseh		LR15YC-1	SUPER	LR15YS-9	SILVER
11 HP Honda (OHV - GX340)	0,6	LR15C	SUPER	LR15S	SILVER
11 HP Tecumseh	0,6	LR15YC	SUPER	LR15YS	SILVER
13 HP Honda		DR17YC	SUPER	DR17YS	SILVER
18 HP B & S		DR17YC	SUPER	DR17YS	SILVER
B & S (all models)	0,6	J19	CLASSIC		
PM O454024, PM O454025, PM O455024	0,6	J19	CLASSIC		
PM O456025, PM O544202, PM O544222	0,6	J19	CLASSIC		
PM O522000, PM O524000, PM O525000		K17C	SUPER		
PM O545202, PM O554222	0,6	J19	CLASSIC		
PM O545305		DR17YC	SUPER	DR17YS	SILVER
Tecumseh (all models)		K17C	SUPER		
Tecumseh Enduro 3000	0,5	LR15C	SUPER	LR15S	SILVER

COMET

MOTOROVÉ PÍLY • CHAINSAW • МОТОПИЛЫ

D 4, D 58		P17	CLASSIC		
-----------	--	-----	---------	--	--

CRAMER

ELEKTROCENTRÁLY / STACIONÁRNÍ MOTORY • ELEKTROCENTRALS / STATIONARY ENGINES • ЭЛЕКТРИЧЕСКИЕ КОММУТАТОРЫ / СТАЦИОНАРНЫЕ ДВИГАТЕЛИ

Tera Cut 3000		LR15YC	SUPER	LR15YS	SILVER
Garden Cut 4000		LR15YC	SUPER	LR15YS	SILVER
Combi Cut B		LR15YC	SUPER	LR15YS	SILVER
CM 60	0,6	N19C	SUPER		
HS 450 BE		LR15YC	SUPER	LR15YS	SILVER
LS 3500, LS 5000, LS 5000H	0,6	N19C	SUPER		

DANARM

KŘOVINŮŘEZY • BRUSH CUTTERS • ТРИММЕРЫ

TM 10C, TM 20	0,5	P17	CLASSIC		
Tornado 18E, Tornado 24E, Tornado 33E	0,5	P17	CLASSIC		
Tornado 40E, Tornado 50E	0,5	P17	CLASSIC		
Whipper 16, Whipper 18E	0,5	P17	CLASSIC		

MOTOROVÉ PÍLY • CHAINSAW • МОТОПИЛЫ

1-36, 1-36 Mk II, 1-36-SS, 1-71-SS		P15	CLASSIC		
2-36-SS		P15	CLASSIC		
36AV, 55, 55LH, 55RH, 76		P15	CLASSIC		

DAVEY

MALOTRAKTORY • TRACTORS • МАЛОГАБАРИТНЫЕ ТРАКТОРЫ

RP 125, RP 160		K17C	SUPER		
----------------	--	------	-------	--	--

DAYTON

MOTOROVÉ PÍLY • CHAINSAW • МОТОПИЛЫ

253	0,5	P15	CLASSIC		
255	0,5	P17	CLASSIC		
2Z-461, 2Z-462, 2Z-463, 2Z-463B, 2Z-573		P17	CLASSIC		
2Z-760, 2Z-970, 2Z-970B, 2Z-971		P17	CLASSIC		
4Z-022, 4Z-023, 4Z-023B, 4Z-109C		P17	CLASSIC		
4Z-251A		P17Y	CLASSIC	PR17YC	SUPER
4Z-252		P15	CLASSIC		

DERBI

MOTOROVÉ PÍLY • CHAINSAW • МОТОПИЛЫ

3835	0,5	P15	CLASSIC		
6240	0,5	P15	CLASSIC		

DISSTON

MOTOROVÉ PÍLY • CHAINSAW • МОТОПИЛЫ

KB 6AY, KB 7AY		K17C	SUPER		
----------------	--	------	-------	--	--



DOLMAR (SACHS DOLMAR)

ELEKTROCENTRÁLY / STACIONÁRNÍ MOTORY • ELEKTROCENTRALS / STATIONARY ENGINES • ЭЛЕКТРИЧЕСКИЕ КОММУТАТОРЫ / СТАЦИОНАРНЫЕ ДВИГАТЕЛИ

309, 309 Happy Start	0,5	PR15Y	CLASSIC	PR17YC	SUPER
343 Happy Start	0,5	PR15Y	CLASSIC	PR17YC	SUPER
HT - 2256D, HT - 2276E		PR15	CLASSIC		
PB - 250		PR15	CLASSIC		
PC - 6412, PC - 7314	0,5	PR15Y	CLASSIC	PR17YC	SUPER
PD - 491		PR15Y	CLASSIC	PR17YC	SUPER

KŘOVINOŘEZY • BRUSH CUTTERS • ТРИММЕРЫ

MS 250.4		SR15C	SUPER		
----------	--	-------	-------	--	--

MOTOROVÉ PILY • CHAINSAW • МОТОПИЛЫ

100, 100s, 102	0,5	UR17Y	CLASSIC		
101, 103, 104, 105, 106, 108	0,5	PR17	CLASSIC		
109	0,5	PR15Y	CLASSIC	PR17YC	SUPER
110 (-06.86)	0,5	UR17	CLASSIC		
110 (07.86-), 110i, 111, 112, 112 Super	0,5	PR15Y	CLASSIC	PR17YC	SUPER
113, 113 Super, 114, 115, 115i, 116Si	0,5	PR15Y	CLASSIC	PR17YC	SUPER
117, 120, 120Si, 120s (02.87-), 121	0,5	PR15Y	CLASSIC	PR17YC	SUPER
118, 122, 122S, 122SL, 128KMS4, 144	0,5	P15	CLASSIC		
118S, 119	0,5	P15Y	CLASSIC	PR17YC	SUPER
123, 133s, 143, 153, 160, 166, 308, 309	0,5	PR15Y	CLASSIC	PR17YC	SUPER
152	0,5	P17	CLASSIC		
310, 343	0,5	PR15Y	CLASSIC	PR17YC	SUPER
PS - 33, PS - 330, PS - 340, PS 341	0,5	UR17Y	CLASSIC		
PS - 34	0,5	PR15Y	CLASSIC	PR17YC	SUPER
PS - 344, PS - 400, PS - 401, PS - 410	0,5	UR17Y	CLASSIC		
PS - 410/33, PS - 411, PS - 411/33	0,5	UR17Y	CLASSIC		
PS - 3300TH	0,5	PR17	CLASSIC		
PS - 6000i, PS - 6000iH, PS - 6400	0,5	PR15Y	CLASSIC	PR17YC	SUPER
PS - 6800i, PS - 6800iH, PS - 7300	0,5	PR15Y	CLASSIC	PR17YC	SUPER
PS - 7900, PS - 9000, PS - 9010	0,5	PR15Y	CLASSIC	PR17YC	SUPER
S 6000	0,5	PR15Y	CLASSIC	PR17YC	SUPER

MOTOROVÉ TRAVNÍ SEKAČKY • LAWN MOWER • СЕНОКОСИЛКИ

LT - 30	0,5	PR15Y	CLASSIC	PR17YC	SUPER
MS - 30C	0,5	PR15Y	CLASSIC	PR17YC	SUPER
MS - 220		PR15	CLASSIC		
PM - 43, PM - 48, PM - 48S	0,6	JR19	CLASSIC		
PM - 4035, PM - 4645SE, PM - 5355S	0,6	J19	CLASSIC		
PM - 4040, PM - 4045SE, PM - 4640HSM	0,6	JR19	CLASSIC		
PM - 4645, PM - 4645S, PM - 4645S2	0,6	JR19	CLASSIC		
PM - 4645S2E, PM - 5355SE	0,6	JR19	CLASSIC		
PM - 4650 (Honda GXV 140)	0,6	LR15YC	SUPER	LR15YS	SILVER
PM - 5360S3CP	0,6	JR19	CLASSIC		
PV - 4034	0,6	JR19	CLASSIC		
TM - 85.13, TM - 85.13H	0,6	DR17YC	SUPER	DR17YS	SILVER
TM - 102.13, TM - 102.17H	0,6	DR17YC	SUPER	DR17YS	SILVER

DYNAMARK

MOTOROVÉ PILY • CHAINSAW • МОТОПИЛЫ

4201, 4221, 4222, 4223		P17Y	CLASSIC	PR17YC	SUPER
4241, 4242, 4243, 4244		P17Y	CLASSIC	PR17YC	SUPER

MOTOROVÉ TRAVNÍ SEKAČKY • LAWN MOWER • СЕНОКОСИЛКИ

All models	0,8	P17	CLASSIC		
------------	-----	-----	---------	--	--

EFCO

KŘOVINOŘEZY • BRUSH CUTTERS • ТРИММЕРЫ

8200, 8260, 8300, 8350, 8400	0,5	PR17Y	CLASSIC	PR17YC	SUPER
Jet 200, Jet 220, Jet 221, Jet 260, Jet 261	0,5	PR17Y	CLASSIC	PR17YC	SUPER
Jet 300, Jet 301, Jet 400, Jet 401	0,5	PR17Y	CLASSIC	PR17YC	SUPER
Jet 450AVS, Jet 460AVS	0,5	PR17Y	CLASSIC	PR17YC	SUPER



service
instructions

... BOSCH ...
... CHAMPION ...
... NGK ...



BRISK

LAST INFO



**STANDARD
BRISK** 

**ALTERNATIVE
BRISK** 

EFCO

KŘOVINOŘEZY • BRUSH CUTTERS • ТРИММЕРЫ

Tiger 40, Tiger 40S, Tiger 50 0,5 PR15Y CLASSIC PR17YC SUPER

MOTOROVÉ PÍLY • CHAINSAW • МОТОПИЛЫ

All models PR15Y CLASSIC PR17YC SUPER

ECHO

ELEKTROCENTRÁLY / STACIONÁRNÍ MOTORY • ELEKTROCENTRALS / STATIONARY ENGINES • ЭЛЕКТРИЧЕСКИЕ КОММУТАТОРЫ / СТАЦИОНАРНЫЕ ДВИГАТЕЛИ

11 HP B & S Vanguard (all models) DR17YC SUPER DR17YS SILVER

14 HP Kohler OHV (all models) DR17YC SUPER DR17YS SILVER

16 HP B & S Vanguard V-Twin (all models) DR17YC SUPER DR17YS SILVER

5 HP B & S (all models) 0,6 J19 CLASSIC

8 HP Kohler (all models) 0,6 J19 CLASSIC

9 HP B & S Vanguard (all models) DR17YC SUPER DR17YS SILVER

EG-550 P17Y CLASSIC PR17YC SUPER

EG-650 (1994-) PR17 CLASSIC

EG-650 (-1993) P17Y CLASSIC PR17YC SUPER

EG-750 P17Y CLASSIC PR17YC SUPER

EG-1500 0,6 NR17YC SUPER

EG-1800 P17 CLASSIC

EG-2300 0,5 NR17YC SUPER

EG-2400 (1994-) NR15C SUPER NR15S SILVER

EG-2400 (-1993) NR17YC SUPER

EG-2600 PR17 CLASSIC

EG-3500 P17Y CLASSIC PR17YC SUPER

EG-3501 (1994-) NR15YC SUPER

EG-3501 (-1993) NR17YC SUPER

EG-4300 NR17YC SUPER

EG-4300E 0,5 NR17YC SUPER

EG-4601, EG-5601, EG-7601 DR17YC SUPER DR17YS SILVER

EG-5500E 0,5 NR17YC SUPER

EG-5600E, EG-7600E DR17YC SUPER DR17YS SILVER

KEH 202D P17 CLASSIC

SV 2 P17 CLASSIC

KŘOVINOŘEZY • BRUSH CUTTERS • ТРИММЕРЫ

CLS - 4600 P15Y CLASSIC PR17YC SUPER

CSAH 302 PR17 CLASSIC

DM 9 PR17 CLASSIC

GT 140B, GT 160, GT 160A PR17 CLASSIC

GT 200 PR17 CLASSIC

GT 2010 P15Y CLASSIC PR17YC SUPER

GTL140A PR17 CLASSIC

HC 140, HC 160, HC 200, HC 210E PR17 CLASSIC

HT 200 P17 CLASSIC

PB 9 K19 CLASSIC

PB 200, PB 202, PB 400, PB 400E PR17 CLASSIC

PE 2400 P15Y CLASSIC PR17YC SUPER

RM 303E P17 CLASSIC

RM 310, RM 380 P15Y CLASSIC PR17YC SUPER

RMA 2530 P15Y CLASSIC PR17YC SUPER

SRA 2190, SRA 2530, SRA 343SL P15Y CLASSIC PR17YC SUPER

SRM 140D, SRM 140DA, SRM 141D PR17 CLASSIC

SRM 160, SRM 200BE, SRM 200D P17 CLASSIC

SRM 200, SRM 200AE, SRM 200DA PR17 CLASSIC

SRM 200B, SRM 200EB PR17 CLASSIC

SRM 200DB P17 CLASSIC

SRM 201FA, SRM 202DA, SRM 202FA PR17 CLASSIC

SRM 210, PR17 CLASSIC

SRM 250E, SRM 250EL P15Y CLASSIC PR17YC SUPER



STANDARD
BRISK

ALTERNATIVE
BRISK

ECHO

KŘOVINOŘEZY • BRUSH CUTTERS • ТРИММЕРЫ

SRM 300ADX, SRM 300AE, SRM 300E		PR17	CLASSIC		
SRM 302ADX, SRM 303E		P17	CLASSIC		
SRM 310, SRM 310E, SRM 345SL		P15Y	CLASSIC	PR17YC	SUPER
SRM 400AE, SRM 400E		P15Y	CLASSIC	PR17YC	SUPER
SRM 501DE, SRM 2010		P17	CLASSIC		
SRM 2090, SRM 2300, SRM 2450		P15Y	CLASSIC	PR17YC	SUPER
SRM 2510		P15Y	CLASSIC	PR17YC	SUPER
SRM 3150		PR15Y	CLASSIC	PR17YC	SUPER
SRM 3500, SRM 3550, SRM 3800		P15Y	CLASSIC	PR17YC	SUPER
SRM 4600		P15Y	CLASSIC	PR17YC	SUPER

MOTOROVÉ PÍLY • CHAINSAW • МОТОПИЛЫ

CLS - 4610		P15Y	CLASSIC	PR17YC	SUPER
CS - 30EVL, CS - 60S, CS - 80Z		PR17	CLASSIC		
CS - 100		PR17	CLASSIC		
CS - 100VL		PR17Y	CLASSIC	PR17YC	SUPER
CS - 280, CS - 280EG, CS - 280EVL		PR17	CLASSIC		
CS - 285EVL, CS - 290EVL, CS - 320EVL		PR17	CLASSIC		
CS - 301, CS - 302, CS - 302S		PR17	CLASSIC		
CS - 302VL, CS - 304, CS - 315, CS - 315VL		PR17	CLASSIC		
CS - 330EVL, CS - 440EVL		PR18Y	CLASSIC		
CS - 330EVL, CS - 351, CS - 351VL		PR17	CLASSIC		
CS - 332		PR15Y	CLASSIC	PR17YC	SUPER
CS - 400, CS - 400EVL		P18Y	CLASSIC		
CS - 451VL, CS - 452VL		PR17	CLASSIC		
CS - 500VL, CS - 500EVL		PR18Y	CLASSIC		
CS - 510EVL		PR15Y	CLASSIC	PR17YC	SUPER
CS - 550EVL		P18Y	CLASSIC		
CS - 600, CS - 601, CS - 601EVL		PR17	CLASSIC		
CS - 601S, CS - 601SVL, CS - 601VL		PR17	CLASSIC		
CS - 602EVL, CS - 602VL		PR15Y	CLASSIC	PR17YC	SUPER
CS - 610VL, CS - 650EVL, CS - 660EVL		PR15Y	CLASSIC	PR17YC	SUPER
CS - 701, CS - 701S		PR17	CLASSIC		
CS - 701SEL, CS - 701SVL, CS - 701VL		PR17	CLASSIC		
CS - 702EVL, CS - 702VL		PR15Y	CLASSIC	PR17YC	SUPER
CS - 801, CS - 802, CS - 802S		PR17	CLASSIC		
CS - 750EVL, CS - 750VL		PR15Y	CLASSIC	PR17YC	SUPER
CS - 852EVL		PR15Y	CLASSIC	PR17YC	SUPER
CS - 900EVL		PR15Y	CLASSIC	PR17YC	SUPER
CS - 1001VL		PR17	CLASSIC		
CS - 2800, CS - 2900		P15Y	CLASSIC	PR17YC	SUPER
CS - 3000, CS - 3400, CS - 3600		P15Y	CLASSIC	PR17YC	SUPER
CS - 3900		P18Y	CLASSIC		
CS - 4000, CS - 4400, CS - 4500		P15Y	CLASSIC	PR17YC	SUPER
CS - 4600, CS - 4601, CS - 5500		P15Y	CLASSIC	PR17YC	SUPER
CS - 5501, CS - 6701, CS - 8000		P15Y	CLASSIC	PR17YC	SUPER
CS - 6700		PR15Y	CLASSIC	PR17YC	SUPER
CSO - 1200	0,5	PR15Y	CLASSIC	PR17YC	SUPER
CST - 600EVL	0,5	PR15Y	CLASSIC	PR17YC	SUPER
HC 160, HC 210, HC 1000, HC 1500		P17	CLASSIC		
QV - 6700		P15Y	CLASSIC	PR17YC	SUPER

MOTOROVÉ TRAVNÍ SEKAČKY • LAWN MOWER • СЕНОКОСИЛКИ

A - 14 B & S - 10,6kW		DR17YC	SUPER	DR17YS	SILVER
A - 16 B & S - 12,1kW		DR17YC	SUPER	DR17YS	SILVER
A - 18 B & S - 13,2kW		DR17YC	SUPER	DR17YS	SILVER
E - 130G, E - 130HY	0,6	JR19	CLASSIC		
E - 150HY B & S - 11,1kW		DR17YC	SUPER	DR17YS	SILVER



service instructions

... BOSCH ...
... CHAMPION ...
... NGK ...



BRISK

LAST INFO

**STANDARD
BRISK**
**ALTERNATIVE
BRISK**
ECHO
MOTOROVÉ TRAVNÍ SEKAČKY • LAWN MOWER • СЕНОКОСИЛКИ

E - 2000HY B & S - 8,5kW	0,6	JR19	CLASSIC		
HO-13-93C Honda 9,6kW	0,6	DR17YC	SUPER	DR17YS	SILVER

FARMER
MOTOROVÉ PÍLY • CHAINSAW • МОТОПИЛЫ

F 55, F 55A, F 65		P15	CLASSIC		
-------------------	--	-----	---------	--	--

FERRARI
MALOTRAKTORY • TRACTORS • МАЛОГАБАРИТНЫЕ ТРАКТОРЫ

All models	0,5	N19C	SUPER		
------------	-----	------	-------	--	--

FIAT
MALOTRAKTORY • TRACTORS • МАЛОГАБАРИТНЫЕ ТРАКТОРЫ

B 20C, B 25C, B 30C		L15YC	SUPER	LR15YS	SILVER
BI 12C, BI 15C, BI 20CL/60		LR14YC	SUPER	LR14YS	SILVER
BI 12C/24, BI 15C/24, BI 20CL/24		L15YC	SUPER	LR15YS	SILVER

FITCHBURG
MOTOROVÉ PÍLY • CHAINSAW • МОТОПИЛЫ

C 6, C 12, C 15 / (A.M.C. 232)		L17YC	SUPER	LR17YS	SILVER
TW 6, TWC 612 / (A.M.C.)		L17YC	SUPER	LR17YS	SILVER
TWC 915 (A.M.C.304,360)		L17YC	SUPER	LR17YS	SILVER

FLYMO
KULTIVÁTORY • CULTIVATORS • КУЛЬТИВАТОРЫ

B & S		JR19	CLASSIC		
Ducati		N17C	SUPER		

MOTOROVÉ TRAVNÍ SEKAČKY • LAWN MOWER • СЕНОКОСИЛКИ

47L, 470L		JR17	CLASSIC		
Aspera	0,8	K19	CLASSIC		
B & S		JR19	CLASSIC		
EC10 (Robin)		K19	CLASSIC		
KAV 74 (Kirby)	0,5	K17Y	CLASSIC		
Tecnamotor	0,6	JR17	CLASSIC		

FOLUX
MOTOROVÉ PÍLY • CHAINSAW • МОТОПИЛЫ

F 2, F 3, F 3A, F 4, F 4A, F 5A, F 6	0,5	PR17Y	CLASSIC	PR17YC	SUPER
F 7, F 7A, F 8, F 30, F 35, F 40	0,5	PR17Y	CLASSIC	PR17YC	SUPER
F 41, F 55A, F 150, F 165, F 180A	0,5	PR17Y	CLASSIC	PR17YC	SUPER

FORD
ELEKTROCENTRÁLY / STACIONÁRNÍ MOTORY • ELEKTROCENTRALS / STATIONARY ENGINES • ЭЛЕКТРИЧЕСКИЕ КОММУТАТОРЫ / СТАЦИОНАРНЫЕ ДВИГАТЕЛИ

67 cu.in., 98 cu.in.		LR15YC-9	SUPER	LR15YS-9	SILVER
104 cu.in.		LR17YC-9	SUPER	LR17YS-9	SILVER
140 cu.in.	0,9	G17YC	SUPER	GR17YS	SILVER
158 cu.in., 175 cu.in., 201 cu.in., 256 cu.in.	0,9	L17C	SUPER		
223 cu.in., 272 cu.in.	0,8	FR15YC	SUPER		
4 cyl. VP 6 (1,2 Ltr.)		L17YC	SUPER	LR17YS	SILVER
4 cyl. VP 6 (1,7 Ltr.)		L14YC	SUPER	LR14YS	SILVER
6 cyl. VP 7 (2,0 Ltr., 85 HP)		L17YC	SUPER	LR17YS	SILVER
6 cyl. VP 7 (2,0 Ltr., 90 HP)		L14YC	SUPER	LR14YS	SILVER
6 cyl. VP 7 (2,3 Ltr., 108 HP)		L14YC	SUPER	LR14YS	SILVER

MOTOROVÉ PÍLY • CHAINSAW • МОТОПИЛЫ

Eagle I, Eagle II		P17	CLASSIC		
Hawk		P17	CLASSIC		

MOTOROVÉ TRAVNÍ SEKAČKY • LAWN MOWER • СЕНОКОСИЛКИ

All models	0,8	P17	CLASSIC		
------------	-----	-----	---------	--	--

FORTSCHRITT
MOTOROVÉ TRAVNÍ SEKAČKY • LAWN MOWER • СЕНОКОСИЛКИ

E 930.50 (A01 / A02)	0,6	N14C	SUPER	NR14S	SILVER
E 931.50 (A01 / A02)	0,6	N14C	SUPER	NR14S	SILVER
E 931.70 (A01 / A02)	0,6	N14C	SUPER	NR14S	SILVER



FOX MOTORI

KŘOVINOŘEZY • BRUSH CUTTERS • ТРИММЕРЫ

F-1, F-7S	0,5	P15	CLASSIC	
-----------	-----	-----	---------	--

MOTOROVÉ TRAVNÍ SEKAČKY • LAWN MOWER • СЕНОКОСИЛКИ

All models		JR19	CLASSIC	
------------	--	------	---------	--

FRONTIER-TML

MOTOROVÉ PÍLY • CHAINSAW • МОТОПИЛЫ

Einhell		P15	CLASSIC	
---------	--	-----	---------	--

F 35, F 35VIP		P15	CLASSIC	
---------------	--	-----	---------	--

FB 35, FB 35VIP		P15	CLASSIC	
-----------------	--	-----	---------	--

Fercad		P15	CLASSIC	
--------	--	-----	---------	--

Greens B		P15	CLASSIC	
----------	--	-----	---------	--

Mark I		P15	CLASSIC	
--------	--	-----	---------	--

Pioneer		P15	CLASSIC	
---------	--	-----	---------	--

Ranch, Rocky		P15	CLASSIC	
--------------	--	-----	---------	--

Star Diffusion		P15	CLASSIC	
----------------	--	-----	---------	--

V.i.P.		P15	CLASSIC	
--------	--	-----	---------	--

FUJI-ROBIN

ELEKTROCENTRÁLY / STACIONÁRNÍ MOTORY • ELEKTROCENTRALS / STATIONARY ENGINES • ЭЛЕКТРИЧЕСКИЕ КОММУТАТОРЫ / СТАЦИОНАРНЫЕ ДВИГАТЕЛИ

SG 550 EY08D		PR17	CLASSIC	
--------------	--	------	---------	--

SG 1000-II EY15D		NR15C	SUPER	NR15S SILVER
------------------	--	-------	-------	--------------

SGL 1500-II EY15D, SGL 2000-II EY20D		NR15C	SUPER	NR15S SILVER
--------------------------------------	--	-------	-------	--------------

SGL 2200-II EY17D		NR15C	SUPER	NR15S SILVER
-------------------	--	-------	-------	--------------

SGL 3000-II EY28D		NR15YC	SUPER	
-------------------	--	--------	-------	--

SGV 2200 EY17D		NR15C	SUPER	NR15S SILVER
----------------	--	-------	-------	--------------

SGV 2600 EY17D, SGV 4000 EH25D		NR15C	SUPER	NR15S SILVER
--------------------------------	--	-------	-------	--------------

GGP

KŘOVINOŘEZY • BRUSH CUTTERS • ТРИММЕРЫ

XB 27D		TR14C	SUPER	TR14S SILVER
--------	--	-------	-------	--------------

XR 27		TR14C	SUPER	TR14S SILVER
-------	--	-------	-------	--------------

MOTOROVÉ PÍLY • CHAINSAW • МОТОПИЛЫ

XC 42P		TR14C	SUPER	TR14S SILVER
--------	--	-------	-------	--------------

XC 350		TR14C	SUPER	TR14S SILVER
--------	--	-------	-------	--------------

GOLDEN STAR

KŘOVINOŘEZY • BRUSH CUTTERS • ТРИММЕРЫ

KFB 633DX, KFB 640DX		P17	CLASSIC	
----------------------	--	-----	---------	--

KFS 218LD		P17	CLASSIC	
-----------	--	-----	---------	--

KFS 418DX, KFS 424DX		P17	CLASSIC	
----------------------	--	-----	---------	--

GOLDONI

MALOTRAKTORY • TRACTORS • МАЛОГАБАРИТНЫЕ ТРАКТОРЫ

All models	0,5	N19C	SUPER	
------------	-----	------	-------	--

GREEN MACHINE

MOTOROVÉ PÍLY • CHAINSAW • МОТОПИЛЫ

7100, 7200, 7400		P17	CLASSIC	
------------------	--	-----	---------	--

7600, 7700		P17Y	CLASSIC	PR17YC SUPER
------------	--	------	---------	--------------

GUTBROD

KULTIVÁTORY • CULTIVATORS • КУЛЬТИВАТОРЫ

B & S - MB 60-52, MB 95-50	0,5	JR19	CLASSIC	
----------------------------	-----	------	---------	--

Tecumseh - VS 40A, VS 50A	0,5	P17	CLASSIC	
---------------------------	-----	-----	---------	--

MALOTRAKTORY • TRACTORS • МАЛОГАБАРИТНЫЕ ТРАКТОРЫ

1010, 1018		K19	CLASSIC	
------------	--	-----	---------	--

2400, 2500	0,6	N17YC	SUPER	
------------	-----	-------	-------	--

3000	0,5	N15C	SUPER	NR15S SILVER
------	-----	------	-------	--------------

ATO 77	0,5	N14C	SUPER	NR14S SILVER
--------	-----	------	-------	--------------

BM 100, BM 100/4BS, BM 700	0,5	JR19	CLASSIC	
----------------------------	-----	------	---------	--

GR 4S	0,5	N15C	SUPER	NR15S SILVER
-------	-----	------	-------	--------------

SR 800	0,5	N17C	SUPER	
--------	-----	------	-------	--

T 113, T 114L, T 116, T 120	0,5	N15C	SUPER	NR15S SILVER
-----------------------------	-----	------	-------	--------------



service instructions

... BOSCH ... CHAMPION ... NGK ...



LAST INFO



STANDARD
BRISK

ALTERNATIVE
BRISK

GUTBROD

MALOTRAKTORY • TRACTORS • МАЛОГАБАРИТНЫЕ ТРАКТОРЫ

T 150	0,5	N19C	SUPER		
T 650	0,5	N15C	SUPER	NR15S	SILVER
ZB 100	0,5	JR19	CLASSIC		

MOTOROVÉ TRAVNÍ SEKAČKY • LAWN MOWER • СЕНОКОСИЛКИ

B & S - HB 40, HB 40L	0,5	JR19	CLASSIC		
B & S - HB 45, HB 45E	0,5	JR19	CLASSIC		
B & S - HB 45LE, HB 45REL	0,5	JR19	CLASSIC		
B & S - HB 46/2T	0,5	JR19	CLASSIC		
B & S - Prof.430G, Prof.510	0,5	JR19	CLASSIC		

HAKO

MALOTRAKTORY • TRACTORS • МАЛОГАБАРИТНЫЕ ТРАКТОРЫ

JLO - Boy	0,5	N15C	SUPER	NR15S	SILVER
Gartentrac 1104E, Gartentrac 1600E		K19	CLASSIC		
Hakomobil 4000	0,6	N15YC	SUPER		
Hakotrac 1200		N19C	SUPER		
Minette		K19	CLASSIC		
Variette	0,5	N14C	SUPER	NR14S	SILVER
Variette 3611		K17C	SUPER		

MOTOROVÉ TRAVNÍ SEKAČKY • LAWN MOWER • СЕНОКОСИЛКИ

B & S	0,6	JR19	CLASSIC		
JLO - 14mm	0,6	N15C	SUPER	NR15S	SILVER
Hako Combinette, Hako Variette	0,6	N17C	SUPER		
Hakorette 150, Hakorette 200	0,6	N17C	SUPER		
Hakotrac 700, Hakotrac 1000		K19	CLASSIC		
Hakotrac 1200, Hakotrac 1400	0,6	N17C	SUPER		
Rasentrac 800E		K19	CLASSIC		

HECHT

MOTOROVÉ PÍLY • CHAINSAW • МОТОПИЛЫ

945		PR15Y	CLASSIC	PR17YC	SUPER
-----	--	-------	---------	--------	-------

HMC

MOTOROVÉ PÍLY • CHAINSAW • МОТОПИЛЫ

Green Machine (Zenoah)		P15	CLASSIC		
------------------------	--	-----	---------	--	--

HOFFCO

ELEKTROCENTRÁLY / STACIONÁRNÍ MOTORY • ELEKTROCENTRALS / STATIONARY ENGINES • ЭЛЕКТРИЧЕСКИЕ КОММУТАТОРЫ / СТАЦИОНАРНЫЕ ДВИГАТЕЛИ

Power Head AV52	0,8	P17	CLASSIC		
Power Head (Tecumseh)	0,8	K19	CLASSIC		

KULTIVÁTORY • CULTIVATORS • КУЛЬТИВАТОРЫ

1493		P17	CLASSIC		
Alladin Fuji		P15	CLASSIC		
GTX-R Genie		P15	CLASSIC		
MP 633		P17	CLASSIC		
P 1A, P 10A, Power Scythe		K19	CLASSIC		

MOTOROVÉ PÍLY • CHAINSAW • МОТОПИЛЫ

D 4, D 58	0,9	P17	CLASSIC		
S 480, Super 510		P17	CLASSIC		
Sickle Bar (Fuji)		P15	CLASSIC		
T 4, T 58	0,9	P17	CLASSIC		
T 47 - Timberline	0,9	K19	CLASSIC		
T 81 - Timberline	0,9	K17C	SUPER		

MOTOROVÉ TRAVNÍ SEKAČKY • LAWN MOWER • СЕНОКОСИЛКИ

B & S		J19	CLASSIC		
Fuji Robin	0,8	P15	CLASSIC		
Power	0,8	K19	CLASSIC		

HOLDER

MALOTRAKTORY • TRACTORS • МАЛОГАБАРИТНЫЕ ТРАКТОРЫ

E 7 (Lombardini - LA300)		N19C	SUPER		
--------------------------	--	------	-------	--	--



HOLDER

МАЛОТРАКТОРЫ • TRACTORS • МАЛОГАБАРИТНЫЕ ТРАКТОРЫ

E 9 (Intermotor)	0,5	N19C	SUPER		
H 3 (Bu.S)		K19	CLASSIC		
H 3 (Fu.S)	0,5	N19C	SUPER		
H 4 (Stamo 96)	0,5	N14C	SUPER	NR14S	SILVER
M 3 (Bu.S)		K19	CLASSIC		
M 3 (Fu.S)	0,5	N17C	SUPER		
MP 1M, MP 1Z	0,5	N15C	SUPER	NR15S	SILVER

HOMELITE

ELEKTROCENTRÁLY / STACIONÁRNÍ MOTORY • ELEKTROCENTRALS / STATIONARY ENGINES • ЭЛЕКТРИЧЕСКИЕ КОММУТАТОРЫ / СТАЦИОНАРНЫЕ ДВИГАТЕЛИ

5 HP B & S	0,5	JR19	CLASSIC		
7 HP B & S	0,5	JR19	CLASSIC		
7,6 HP Robin		NR15YC	SUPER		
8 HP B & S	0,5	JR19	CLASSIC		
9 HP B & S Vanguard		DR17YC	SUPER	DR17YS	SILVER
10 HP B & S	0,5	JR19	CLASSIC		
11 HP B & S	0,5	JR19	CLASSIC		
11 HP Robin		NR15C	SUPER	NR15S	SILVER
176B140A	0,6	J19	CLASSIC		
176R142A		NR15YC	SUPER		
178H148	0,6	LR17YC	SUPER	LR17YS	SILVER
178V152		DR17YC	SUPER	DR17YS	SILVER
180HIE63	0,6	LR17YC	SUPER	LR17YS	SILVER
180R162, 180RIE162		NR15C	SUPER	NR15S	SILVER
18mm Hd	0,9	FR17YC	SUPER		
190HHY50	0,5	JR19	CLASSIC		
CG 4800 / 178H148, CG 5200	0,6	LR17YC	SUPER	LR17YS	SILVER
CG 6300 / 180H163		LR17YC	SUPER	LR17YS	SILVER
CGE 6300 / 180HIE63	0,5	JR19	CLASSIC		
CHY 5000 / 190HHY50	0,5	JR19	CLASSIC		
EH 2500HD	0,5	JR19	CLASSIC		
EH 4400HD, EH 5500HD	0,5	JR19	CLASSIC		
EHE 4400HD, EHE 5500HD	0,5	JR19	CLASSIC		
EHRL 4400HD	0,5	JR19	CLASSIC		
HG 3500	0,5	JR19	CLASSIC		
HG 50-1400, HG 50-2500		NR15C	SUPER	NR15S	SILVER
HG 600		NR15C	SUPER	NR15S	SILVER
HGE 3500	0,5	JR19	CLASSIC		
HL 2500, HL 4400	0,5	JR19	CLASSIC		
Homelite		K17C	SUPER		
LR 2500, LR 4400, LR 5500	0,5	JR19	CLASSIC		
LRE 5500	0,5	JR19	CLASSIC		
LRI 2500, LRI 4400, LRI 5500	0,5	JR19	CLASSIC		
LRIE 5500	0,5	JR19	CLASSIC		
Yamaha		NR15YC	SUPER		

KŘOVINOŘEZY • BRUSH CUTTERS • ТРИММЕРЫ

HK 18, HK 24, HK 28, HK 33		P17	CLASSIC		
HPW 1200B	0,6	J19	CLASSIC		
ST 400		P15	CLASSIC		
XLBC-4		P15	CLASSIC		

MOTOROVÉ PILY • CHAINSAW • МОТОПИЛЫ

150, 190		U17	CLASSIC		
290, 340		PR15Y	CLASSIC	PR17YC	SUPER
350, 360		P15	CLASSIC		
450, 550		U17	CLASSIC		
650, 750		P15	CLASSIC		



service
instructions

... BOSCH ...
... CHAMPION ...
... NGK ...



cross reference



LAST INFO

**STANDARD
BRISK**
**ALTERNATIVE
BRISK**
HOMELITE
MOTOROVÉ PILY • CHAINSAW • МОТОПИЛЫ

945, 955	P15	CLASSIC		
1130G, 2100S, 3100G	P15	CLASSIC		
C 72	K17C	SUPER		
DM 20 Multi-Purpose	P15	CLASSIC		
Mini (all models)	U15	CLASSIC		
Super 1050, Super 1130G, Super 2100	P15	CLASSIC		
Super EZ-AO, Super EZ	U15	CLASSIC		
Super XL, Super XL-AO	P15	CLASSIC		
Super XL 123, Super VI 123	P15	CLASSIC		
Super XL 650F	P15	CLASSIC		
Super XL-925	P15	CLASSIC		
Super 2, Super VI 2	U17	CLASSIC		
Super Wiz 55, Super Wiz 66	P15	CLASSIC		
Super Wiz 80	K19	CLASSIC		
XL, XL-2	U17	CLASSIC		
XL-12, XL 100A	P17	CLASSIC		
XL-98A Multi-Purpose	P15	CLASSIC		
XL 123, VI 123, XL 660F	P15	CLASSIC		
XL 923, XL923A, XL 925	P15	CLASSIC		
V1-944	P15	CLASSIC		
V1-955, V1-1050	P15	CLASSIC		

HOMELITE-JACOBSEN
MOTOROVÉ TRAVNÍ SEKAČKY • LAWN MOWER • СЕНОКОСИЛКИ

B & S	JR19	CLASSIC		
Tecumseh	JR17	CLASSIC		
HSC 20-2	J19	CLASSIC		
HSD 20, HSD 20P	0,6 J19	CLASSIC		
HSD 20-2, HSD 20P-2, HSD 20V	J19	CLASSIC		

HONDA
ELEKTROCENTRÁLY / STACIONÁRNÍ MOTORY • ELEKTROCENTRALS / STATIONARY ENGINES • ЭЛЕКТРИЧЕСКИЕ КОММУТАТОРЫ / СТАЦИОНАРНЫЕ ДВИГАТЕЛИ

E 40, E 80, E 100		NAR15YS	SILVER		
E 300 / C, E 300K1 / K2 / K3, E 400		NAR15YS	SILVER		
E 600, E 800A, E 900		NAR14YC	SUPER	NAR14YS	SILVER
E 1000	0,6	N15C	SUPER	NR15S	SILVER
E 1500, E1500E, E 1500K1 / K2 / K3 (G42)	0,6	N15C	SUPER	NR15S	SILVER
E 1500K4 (G200)	0,6	N17C	SUPER		
E 1500 (G200) CDI ign.	0,9	NR17YC	SUPER		
E 2000	0,6	N15C	SUPER	NR15S	SILVER
E 2500, E 2500K1 / K2 / K3 / K4 (G300)	0,6	NR17C	SUPER		
E 3500, E 3500K1 / K2	0,6	N17C	SUPER		
E 3500 CDI ign.	0,9	NR17YC	SUPER		
E 4500	0,9	NR17YC	SUPER		
EB 1200X (GX110), EB 1400X	0,6	LR15YC	SUPER	LR15YS	SILVER
EB 1500, EB 1900 (GE200), EB 1800	0,9	NR17YC	SUPER		
EB 1500X, EB 1800X, EB 1900X (GX140)	0,6	LR15YC	SUPER	LR15YS	SILVER
EB 2200X	0,6	LR15YC	SUPER	LR15YS	SILVER
EB 2500XK1	0,6	LR17YC	SUPER	LR17YS	SILVER
EB 2800(GE300), EB 3800 (G400), EB 4000	0,9	NR17YC	SUPER		
EB 3000	0,6	NR17C	SUPER		
EB 3000C, EB 3000X, EB 3500X	0,6	LR17YC	SUPER	LR17YS	SILVER
EB 3500XK1, EB 3800XA	0,6	LR17YC	SUPER	LR17YS	SILVER
EB 4500, EB 4500X, EB 5000	0,6	LR15YC	SUPER	LR15YS	SILVER
EB 5000X, EB 5000XK1, EB 5000XK1A	0,6	LR17YC	SUPER	LR17YS	SILVER
EB 6500SXA, EB 11000	0,6	LR17YC	SUPER	LR17YS	SILVER
EBK 2000	0,9	NR17YC	SUPER		
EBK 2600	0,6	NR17C	SUPER		



HONDA

ELEKTROCENTRÁLY / STACIONÁRNÍ MOTORY • ELEKTROCENTRALS / STATIONARY ENGINES • ЭЛЕКТРИЧЕСКИЕ КОММУТАТОРЫ / СТАЦИОНАРНЫЕ ДВИГАТЕЛИ

EBK 3600	0,6	NR17C	SUPER		
EC 1500	0,6	N17C	SUPER		
EC 2100 C, EC 2200, EC 2200L	0,6	LR15YC	SUPER	LR15YS	SILVER
EC 4000, EC 4500P, EC 6000	0,6	LR15YC	SUPER	LR15YS	SILVER
ECM 2800		LR15YC	SUPER	LR15YS	SILVER
ECMT 6500		LR15YC	SUPER	LR15YS	SILVER
ECMT 6500P		LR15YC	SUPER	LR15YS	SILVER
ECT 6500	0,6	LR15YC	SUPER	LR15YS	SILVER
ECT 6500P	0,6	LR15YC	SUPER	LR15YS	SILVER
ED 250		NAR15YS	SILVER		
ED 300	0,9	PR18Y	CLASSIC		
ED 350, ED 400		PR17	CLASSIC		
ED 1000, ED 1000A	0,5	N17C	SUPER		
ED 1000X		LR15YC	SUPER	LR15YS	SILVER
EG 550, EG 650		PR17	CLASSIC		
EG 850X, EG 1000X	0,6	LR15YC	SUPER	LR15YS	SILVER
EG 850Z, EG 1000 (G150), EG 1000Z (GE150)	0,6	N19C	SUPER		
EG 1000A, EG 1500	0,5	N17C	SUPER		
EG 1200, EG 1200X (GX110, GX120K1)	0,6	LR15YC	SUPER	LR15YS	SILVER
EG 1200Z, EG 1500Z, EG 1800Z, EG 1900Z	0,6	N19C	SUPER		
EG 1400X, EG 1400XK1	0,6	LR15YC	SUPER	LR15YS	SILVER
EG 1400Z	0,6	NR17C	SUPER		
EG 1500K3	0,6	N17C	SUPER		
EG 1500K4	0,6	N17C	SUPER		
EG 1500X, EG 1800X, EG 1900X (GX140)	0,6	LR15YC	SUPER	LR15YS	SILVER
EG 2000X, EG 2200, EG 2200X	0,6	LR15YC	SUPER	LR15YS	SILVER
EG 2200Z, EG 3000 (GX240)	0,6	N19C	SUPER		
EG 2500XK1, EG 3000	0,6	LR17YC	SUPER	LR17YS	SILVER
EG 3000X, EG 3500X	0,6	LR15YC	SUPER	LR15YS	SILVER
EG 4000	0,6	N19C	SUPER		
EG 4500, EG 5000	0,6	LR15YC	SUPER	LR15YS	SILVER
EG 4500 X		LR17YC-1	SUPER	LR17YS-9	SILVER
EG 4500X		LR17YC	SUPER	LR17YS	SILVER
EGK 600		P17	CLASSIC		
EGK 1000, EGK 1200, EGK 1600	0,6	N19C	SUPER		
EGK 2000, EGK 2600, EGK 3600	0,6	N19C	SUPER		
EJ 3	0,6	NR15YC	SUPER		
EL 80		NAR15YS	SILVER		
EL 5000	0,6	NR15YC	SUPER		
EM 25, EM 30	0,6	LR15YC	SUPER	LR15YS	SILVER
EM 50iS, EM 70iS	0,6	LR17YC	SUPER	LR17YS	SILVER
EM 300, EM 400, EM 400K1		NAR15YS	SILVER		
EM 500, EM 500A, EM 500K1, EM 600	0,9	PR18Y	CLASSIC		
EM 650		PR17	CLASSIC		
EM 1200X (GX110), EM 1400X	0,6	LR15YC	SUPER	LR15YS	SILVER
EM 1500 (GX200), EM 1900 (GX200), EM 1800	0,9	NR17YC	SUPER		
EM 1500X, EM 1600X, EM 1800X, EM 1900X	0,6	LR15YC	SUPER	LR15YS	SILVER
EM 1600	0,6	N17C	SUPER		
EM 2200, EM 2200X	0,6	LR15YC	SUPER	LR15YS	SILVER
EM 2500XK1	0,6	LR17YC	SUPER	LR17YS	SILVER
EM 3000	0,9	NR17YC	SUPER		
EM 3000SX, EM 3000X, EM 3500SX, EM 3500X	0,6	LR17YC	SUPER	LR17YS	SILVER
EM 4000	0,9	NR17YC	SUPER		
EM 4500	0,6	LR15YC	SUPER	LR15YS	SILVER
EM 4500CX, EM 4500CXS, EM 4500SX	0,6	LR17YC	SUPER	LR17YS	SILVER
EM 5000, EM 5000SX	0,6	LR15YC	SUPER	LR15YS	SILVER



service
instructions

... BOSCH ...
... CHAMPION ...
... NGK ...



BRISK

LAST INFO



STANDARD
BRISK

ALTERNATIVE
BRISK

HONDA

ELEKTROCENTRÁLY / STACIONÁRNÍ MOTORY • ELEKTROCENTRALS / STATIONARY ENGINES • ЭЛЕКТРИЧЕСКИЕ КОММУТАТОРЫ / СТАЦИОНАРНЫЕ ДВИГАТЕЛИ

EM 5500CX, EM 5500CXS	0,6	LR17YC	SUPER	LR17YS	SILVER
EMS 2800 (GE300), EMS 3000	0,9	NR17YC	SUPER		
EMS 3800 (G400), EMS 4000	0,9	NR17YC	SUPER		
EMS 4500	0,6	N17YC	SUPER		
EN 2500 (Honda 5 HP - OHV)		LR15YC	SUPER	LR15YS	SILVER
ER 1500	0,5	N17C	SUPER		
ES 3500K1 (G400K1), ES 3500K2	0,6	N19C	SUPER		
ES 3500 (G400), ES 4500 (G400)	0,9	NR17YC	SUPER		
ES 5500K1 (GX360K1), ES 6500, ES 6500K1	0,6	NR15YC	SUPER		
ES 5500 (GX360)	0,9	NR15YC	SUPER		
ET 4500	0,9	NR17YC	SUPER		
ET 4500X	0,6	LR15YC	SUPER	LR15YS	SILVER
EU 10i, EU 19i		NAR15YS	SILVER		
EU 20, EU 20i	0,5	NAR15YS	SILVER		
EU 26i, EU 30iS	0,6	LR17YC	SUPER	LR17YS	SILVER
EU 30i		LR17YC	SUPER	LR17YS	SILVER
EU 200i, EU 2000i	0,6	LR17YC	SUPER	LR17YS	SILVER
EU 1000IA2	0,8	NAR14YC	SUPER	NAR14YS	SILVER
EU 3000IS	0,6	LR17YC	SUPER	LR17YS	SILVER
EV 3600, EV 4000	0,9	NR15YC	SUPER		
EV 3610		N19C	SUPER		
EV 4010, EV 6010	0,6	NR17YC	SUPER		
EV 5010		NR15YC	SUPER		
EVD 4010	0,6	N17YC	SUPER		
EW 140, EW 171K1	0,6	LR17YC	SUPER	LR17YS	SILVER
EW 170	0,6	N19C	SUPER		
EW 171	0,6	LR15YC	SUPER	LR15YS	SILVER
EX 7		NAR15YS	SILVER		
EX 100	0,6	N19C	SUPER		
EX 350, EX 650		PR17	CLASSIC		
EX 500, EX 500K1	0,9	PR18Y	CLASSIC		
EX 800	0,9	NR17YC	SUPER		
EX 700c	0,8	NAR14YC	SUPER	NAR14YS	SILVER
EX 900, EX 1000	0,6	N19C	SUPER		
EX 1900, EX 2100, EX 2200	0,6	LR15YC	SUPER	LR15YS	SILVER
EX 3000, EX 3000S	0,6	LR17YC	SUPER	LR17YS	SILVER
EX 3300, EX 3300S, EX 3300SKI, EX 4500	0,6	LR15YC	SUPER	LR15YS	SILVER
EX 4000, EX 4000S (GX340)	0,6	LR17YC	SUPER	LR17YS	SILVER
EX 4500S, EX 4500SK1A	0,6	LR17YC	SUPER	LR17YS	SILVER
EX 5000	0,5	PR18Y	CLASSIC		
EX 5500, EX 5500K1, EX 5500K2A	0,6	NR15YC	SUPER		
EZ 1400A (Honda 4 HP - OHV)		LR17YC	SUPER	LR17YS	SILVER
EZ 2200		LR17YC	SUPER	LR17YS	SILVER
EZ 2500A (Honda 5,5 HP - OHV)		LR17YC	SUPER	LR17YS	SILVER
EZ 3500A (Honda 8 HP - OHV)		LR17YC	SUPER	LR17YS	SILVER
EZ 4500		LR17YC-1	SUPER	LR17YS-9	SILVER
EZ 5000A (Honda 11 HP - OHV)		LR17YC	SUPER	LR17YS	SILVER
F 28	0,8	NAR15YS	SILVER		
F 400		N17C	SUPER		
FD 1000	0,5	N15C	SUPER	NR15S	SILVER
G 20, G 40, G 41, G 42	0,6	N17C	SUPER		
G 25, G 28, G 30, G 35	0,8	NAR14YC	SUPER	NAR14YS	SILVER
G 45, G 50, G 65, G 65K1, G 80	0,6	N17C	SUPER		
G 100 (2,2 HP), G 100K1 (2,5 HP)		PR17	CLASSIC		
G 100K2		PR18Y	CLASSIC		
G 101, G 300	0,6	N17YC	SUPER		



HONDA

ELEKTROCENTRÁLY / STACIONÁRNÍ MOTORY • ELEKTROCENTRALS / STATIONARY ENGINES • ЭЛЕКТРИЧЕСКИЕ КОММУТАТОРЫ / СТАЦИОНАРНЫЕ ДВИГАТЕЛИ

G 150 (3,5 HP), G 150 CDI, G 150K1	0,6	N19C	SUPER		
G 200 (5,0 HP), G 200K1, G 300	0,6	N19C	SUPER		
G 200 CDI	0,9	NR17YC	SUPER		
G 300 CDI	0,9	NR17YC	SUPER		
G 400, G 400K1 CDI	0,9	NR17YC	SUPER		
G 400K1		NR17YC	SUPER		
GC 135, GC 150, GC 160, GC 190		LR15YC	SUPER	LR15YS	SILVER
GCV 135, GCV 160, GCV 190		LR15YC	SUPER	LR15YS	SILVER
GCV 520		LR17YC	SUPER	LR17YS	SILVER
GCV 530		LR17YC	SUPER	LR17YS	SILVER
GS 35	0,6	N17C	SUPER		
GS 160, GS 190 (6 HP)		LR15YC	SUPER	LR15YS	SILVER
GSV 160, GSV 190 (6,5 HP)		LR15YC	SUPER	LR15YS	SILVER
GV 35 (3,5 HP)	0,8	NAR14YC	SUPER	NAR14YS	SILVER
GV 100, GV 100K1		PR17	CLASSIC		
GV 100K2		PR18Y	CLASSIC		
GV 150 (CDI - 3,5 HP) -2029058		N15YC	SUPER		
GV 150 (Mag. - 3,5 HP) -2029058		N17C	SUPER		
GV 150 (CDI - 3,5 HP) 2029059-	0,8	P18Y	CLASSIC		
GV 150 (Mag. - 3,5 HP) 2029059-		P17	CLASSIC		
GV 200, GV 400		PR17	CLASSIC		
GV 200 CDI, GV 400CDI	0,8	PR18Y	CLASSIC		
GX 22, GX 30, GX 31, GX 100, GX 100TAMP		NAR15YS	SILVER		
GX 25, GX 35		TR17	CLASSIC	TR17C	SUPER
GX 110		LR15YC	SUPER	LR15YS	SILVER
GX 120 (-3235089)		L17YC	SUPER	LR17YS	SILVER
GX 120 (3235090-)		LR17YC	SUPER	LR17YS	SILVER
GX 120 (Heavy service), GX 140		LR15YC	SUPER	LR15YS	SILVER
GX 160, GX 160K1		LR15YC	SUPER	LR15YS	SILVER
GX 160T1		LR17YC	SUPER	LR17YS	SILVER
GX 200, GX 240		LR15YC	SUPER	LR15YS	SILVER
GX 240K1		LR17YC	SUPER	LR17YS	SILVER
GX 270, GX 340, GX 340K1		LR15YC	SUPER	LR15YS	SILVER
GX 360, GX 360K1		NR17YC	SUPER		
GX 390, GX 390K1, GX 610		LR15YC	SUPER	LR15YS	SILVER
GX 610K1		LR17YC	SUPER	LR17YS	SILVER
GX 620		LR15YC	SUPER	LR15YS	SILVER
GX 620K1		LR17YC	SUPER	LR17YS	SILVER
GX 640, GX 670		LR17YC	SUPER	LR17YS	SILVER
GXH 50	0,8	NAR15YS	SILVER		
GXV 50	0,8	NAR15YS	SILVER		
GXV 120, GXV 140, GXV 160, GXV 160K1		LR17YC	SUPER	LR17YS	SILVER
GXV 160H2, GXV 200, GXV 240		LR17YC	SUPER	LR17YS	SILVER
GXV 270, GXV 270K1, GXV 340, GXV 340K1		LR17YC	SUPER	LR17YS	SILVER
GXV 340K2, GXV 340T2, GXV 390, GXV 390K1		LR17YC	SUPER	LR17YS	SILVER
GXV 390K2, GXV 520, GXV 530, GXV 610		LR17YC	SUPER	LR17YS	SILVER
GXV 610K1, GXV 620, GXV 620K1, GXV 670		LR17YC	SUPER	LR17YS	SILVER
HH 31C		NAR15YS	SILVER		
HH-BH 25, HH-E 31CA		TR17	CLASSIC	TR17C	SUPER
HH-H 25D-60, HH-H 25D-75, HH-H 25S-75		TR17	CLASSIC	TR17C	SUPER
HH-T 25SLTA, HH-T 31S, HH-T31TA		NAR15YS	SILVER		
HH-TUMK 25		NAR15YS	SILVER		
Honda 2,4 HP	0,8	P17	CLASSIC		
Honda 3,5 HP, Honda 4,5 HP		LR17YC	SUPER	LR17YS	SILVER
Honda 5 HP (OHV)		LR15YC	SUPER	LR15YS	SILVER
Honda 5,5 HP (OHV)		LR17YC	SUPER	LR17YS	SILVER



service
instructions

... BOSCH ...
... CHAMPION ...
... NGK ...



LAST INFO



**STANDARD
BRISK**

**ALTERNATIVE
BRISK**

HONDA

ELEKTROCENTRÁLY / STACIONÁRNÍ MOTORY • ELEKTROCENTRALS / STATIONARY ENGINES • ЭЛЕКТРИЧЕСКИЕ КОММУТАТОРЫ / СТАЦИОНАРНЫЕ ДВИГАТЕЛИ

Honda 11 HP, Honda 13 HP / OHV	LR17YC	SUPER	LR17YS	SILVER
Honda 18 HP, 20 HP (V-Twin)	LR17YC	SUPER	LR17YS	SILVER
HS 522, HS 550, HS 621, HS 622T, HS 622TA	LR17YC	SUPER	LR17YS	SILVER
HS 622TS, HS 622W, HS 624T, HS 624TS	LR17YC	SUPER	LR17YS	SILVER
HS 624W, HS 624WS, HS 760, HS 828TS	LR17YC	SUPER	LR17YS	SILVER
HS 828W, HS 828WS, HS 970	LR17YC	SUPER	LR17YS	SILVER
HS 1132TA, HS 1132TAS	LR17YC	SUPER	LR17YS	SILVER
HS 1136 (GX340CDI), HS 1180	LR17YC	SUPER	LR17YS	SILVER
HS 1390, HS 1810	LR17YC	SUPER	LR17YS	SILVER
IGX 440 (4Takt)	DR15YC	SUPER	DR15YS	SILVER
WB 10, WB 15	PR17	CLASSIC		
WB 20XT, WB 30XT	LR15YC	SUPER	LR15YS	SILVER
WH 15X, WH 20X	LR15YC	SUPER	LR15YS	SILVER
WJR 1525, WJR 2525	TR17	CLASSIC	TR17C	SUPER
WMP 20X	LR15YC	SUPER	LR15YS	SILVER
WN 20	LR15YC	SUPER	LR15YS	SILVER
WP 20X, WP 30X	LR15YC	SUPER	LR15YS	SILVER
WT 30X, WT 40X	LR15YC	SUPER	LR15YS	SILVER
WX 10, WX 15	NAR15YS	SILVER		

KŘOVINOŘEZY • BRUSH CUTTERS • ТРИММЕРЫ

UMK 425 L3E, UMK 425 LE,	TR17	CLASSIC	TR17C	SUPER
UMK 425 U3E, UMK 425 UE	TR17	CLASSIC	TR17C	SUPER
UMS 425 LE	TR17	CLASSIC	TR17C	SUPER

KULTIVÁTORY • CULTIVATORS • КУЛЬТИВАТОРЫ

F 28, F 220		NAR15YS	SILVER	
F 30, F 40, F 42, F 65	0,6	N17C	SUPER	
F 80	0,6	L17C	SUPER	
F 110, F 200, F 200D, F 210, F 250, F 300		PR17	CLASSIC	
F 325		LR15YC	SUPER	LR15YS SILVER
F 360		LR17YC	SUPER	LR17YS SILVER
F 400, F 600, F 800	0,6	N17C	SUPER	
F 400S	0,6	N17YC	SUPER	
F 401A, F401A2, F 401AD, F 401K, F 401K2		LR17YC	SUPER	LR17YS SILVER
F 500		N19C	SUPER	
F 501, F 501A1, F 501A2, F 501K1, F 501K2		LR17YC	SUPER	LR17YS SILVER
F 501K2A1		LR17YC	SUPER	LR17YS SILVER
F 560, F 660, F 720, F 810		LR17YC	SUPER	LR17YS SILVER
FF 300		NAR15YS	SILVER	
FF 500		LR15YC	SUPER	LR15YS SILVER
FG 100		NAR15YS	SILVER	
FG 110		TR17	CLASSIC	TR17C SUPER
FG 200, FG 201, FG 205, FG 220	0,5	NAR15YS	SILVER	
FG 315, FG 400A1		LR15YC	SUPER	LR15YS SILVER
FG 500		LR15YC	SUPER	LR15YS SILVER
FG 500A1		LR17YC	SUPER	LR17YS SILVER
FR 600, FR 650, FR 750, FR 800		LR17YC	SUPER	LR17YS SILVER
FR 700		N19C	SUPER	
FRC 800		LR17YC	SUPER	LR17YS SILVER
FS 50	0,6	N17C	SUPER	
FU 750 Lucky		LR15YC	SUPER	LR15YS SILVER
FX 25	0,6	N17C	SUPER	
HRA 21-4PB, HRA 21-4SB, HRA 21-4SXG		LR15YC-9	SUPER	LR15YS-9 SILVER
HT 38-10, HT 38-13		N17C	SUPER	
HTR 3009		LR17YC	SUPER	LR17YS SILVER

МАЛОТРАКТОРЫ • TRACTORS • МАЛОГАБАРИТНЫЕ ТРАКТОРЫ

ED 300	0,9	P17Y	CLASSIC	PR17YC SUPER
--------	-----	------	---------	--------------



HONDA

MALOTRAKTORY • TRACTORS • МАЛОГАБАРИТНЫЕ ТРАКТОРЫ

EM 500	0,9	P17Y	CLASSIC	PR17YC	SUPER
EX 500	0,9	P17Y	CLASSIC	PR17YC	SUPER
F 400,F 450,F 500		N17C	SUPER		
FR 500		N17C	SUPER		
H 5518		LR17YC	SUPER	LR17YS	SILVER
HP 250		PR17	CLASSIC		
HP 300, HP 400		LR17YC	SUPER	LR17YS	SILVER
HP 500BXE, HP 500NXE		LR15YC	SUPER	LR15YS	SILVER

MOTOROVÉ TRAVNÍ SEKAČKY • LAWN MOWER • СЕНОКОСИЛКИ

GXV 110		N17C	SUPER		
GXV 120		LR17YC	SUPER	LR17YS	SILVER
H 1011H, H 1011HSA, H 1011RSA		LR17YC	SUPER	LR17YS	SILVER
H 1011S, H 1011SA		LR17YC	SUPER	LR17YS	SILVER
H 2013HSA, H 2013S, H 2013SDA		LR17YC	SUPER	LR17YS	SILVER
H 2113HDA, H 2113SDA		LR17YC	SUPER	LR17YS	SILVER
H 3001, H 3001H, H 3009		LR17YC	SUPER	LR17YS	SILVER
H 3011, H 3013H, H 4013		LR17YC	SUPER	LR17YS	SILVER
H 4118HDA, H 4120HDA, H 4514, H 4514HSA		LR17YC	SUPER	LR17YS	SILVER
H 4514H		NR17YC	SUPER		
H 4518, H 4518H, H 4518HSA		LR17YC	SUPER	LR17YS	SILVER
H 5013, H 5013A2, H 5013A4, H 5518		LR17YC	SUPER	LR17YS	SILVER
HC 16		PR17	CLASSIC		
HC 20, HC 26		LR15YC	SUPER	LR15YS	SILVER
HF 1211, HF 1211H, HF 1211S		LR17YC	SUPER	LR17YS	SILVER
HF 2113H, HF 2113S		LR15YC	SUPER	LR15YS	SILVER
HF 2114S, HF 2114H		LR17YC	SUPER	LR17YS	SILVER
HF 2200S, HF 2200H		LR17YC	SUPER	LR17YS	SILVER
HF 2213, HF 2213H, HF 2213S		LR17YC	SUPER	LR17YS	SILVER
HF 2216S, HF 2216H		LR17YC	SUPER	LR17YS	SILVER
HF 2218HL, HF 2218SL		LR17YC	SUPER	LR17YS	SILVER
HF 2220HL, HF 2220SL		LR17YC	SUPER	LR17YS	SILVER
HF 2315HM, HF 2315SB		LR17YC	SUPER	LR17YS	SILVER
HF 2415SB, HF 2417HAT, HF 2417HM		LR17YC	SUPER	LR17YS	SILVER
HF 2620HAT, HF 2620HM		NAR15YS	SILVER		
HR 17, HR 17.3	0,8	P17	CLASSIC		
HR 19.4		LR17YC	SUPER	LR17YS	SILVER
HR 21 (Std. Ign.) -2029058		N17YC	SUPER		
HR 21 (Std. Ign.) 2029059-		PR17	CLASSIC		
HR 21 (CDI) -2029058	0,9	N19C	SUPER		
HR 21 (CDI) 2029059-	0,8	P18Y	CLASSIC		
HR 21.5		PR18Y	CLASSIC		
HR 194, HR 195, HR 214, HR 216, HR 216C		LR17YC	SUPER	LR17YS	SILVER
HR 215, HR 215K1HMA, HR 215K1HXA		LR15YC	SUPER	LR15YS	SILVER
HR 215K1SXA		LR15YC	SUPER	LR15YS	SILVER
HR 521		N19C	SUPER		
HR 1950S, HR 1950SM, HR 1950SX		LR17YC	SUPER	LR17YS	SILVER
HR 2150, HR 2160, HR 4013SA		LR17YC	SUPER	LR17YS	SILVER
HRA 21, HRA 173		PR17	CLASSIC		
HRA 214, HRA 216		LR17YC	SUPER	LR17YS	SILVER
HRA 215		LR15YC	SUPER	LR15YS	SILVER
HRA 219		LR17YC	SUPER	LR17YS	SILVER
HRA 536HX	0,6	LR17YC	SUPER	LR17YS	SILVER
HRA 2150		LR15YC	SUPER	LR15YS	SILVER
HRA 2160		LR17YC	SUPER	LR17YS	SILVER
HRB 215, HRB 215HXA, HRB 215PXA		LR15YC	SUPER	LR15YS	SILVER
HRB 215SDA, HRB 215SXA		LR15YC	SUPER	LR15YS	SILVER



service instructions

... BOSCH ...
... CHAMPION ...
... NGK ...



LAST INFO

**STANDARD
BRISK**
**ALTERNATIVE
BRISK**
HONDA
MOTOROVÉ TRAVNÍ SEKAČKY • LAWN MOWER • СЕНОКОСИЛКИ

HRB 217TDA, HRB 217HXA		LR17YC	SUPER	LR17YS	SILVER
HRB 423P, HRB 423PD, HRB 423S		PR17	CLASSIC		
HRB 423SD, HRB 423SX		PR17	CLASSIC		
HRB 425C, HRB 425CPD, HRB 425CPX		LR15YC	SUPER	LR15YS	SILVER
HRB 425CSD, HRB 425CSX		LR15YC	SUPER	LR15YS	SILVER
HRB 475 HM		LR17YC	SUPER	LR17YS	SILVER
HRB 475 SM	0,6	LR17YC	SUPER	LR17YS	SILVER
HRB 475CPD, HRB 475CSD		LR15YC	SUPER	LR15YS	SILVER
HRB 475HX, HRB 475P, HRB 475PD		LR17YC	SUPER	LR17YS	SILVER
HRB 475S, HRB 475SD, HRB 475SX		LR17YC	SUPER	LR17YS	SILVER
HRB 476CHX, HRB 476CTX	0,6	LR15YC	SUPER	LR15YS	SILVER
HRB 476C HX, HRB 476CPD, HRB 476CPX		LR15YC	SUPER	LR15YS	SILVER
HRB 476CSD, HRB 476CSX		LR15YC	SUPER	LR15YS	SILVER
HRB 535SX		LR17YC	SUPER	LR17YS	SILVER
HRB 536CSX, HRB 536CTX		LR15YC	SUPER	LR15YS	SILVER
HRC 215K1PDA, HRC 215K1SDA		LR15YC	SUPER	LR15YS	SILVER
HRC 216K1HXA, HRC 216K1SXA		LR17YC	SUPER	LR17YS	SILVER
HRC 217TDA, HRC 7013, HRC 7018		LR17YC	SUPER	LR17YS	SILVER
HRC 7020, HRC 7113TXA		LR17YC	SUPER	LR17YS	SILVER
HRD 535QX		LR17YC	SUPER	LR17YS	SILVER
HRD 535TM	0,6	LR17YC	SUPER	LR17YS	SILVER
HRD 535HX, HRD 535SM, HRD 535SX		LR17YC	SUPER	LR17YS	SILVER
HRD 536HXE		LR17YC	SUPER	LR17YS	SILVER
HRD 536QX		LR17YC	SUPER	LR17YS	SILVER
HRD 536CHX, HRD 536CSX, HRD 536CTX		LR15YC	SUPER	LR15YS	SILVER
HRD 536HM, HRD 536HX		LR17YC	SUPER	LR17YS	SILVER
HRF 465, HRF 465P, HRF 465S		LR17YC	SUPER	LR17YS	SILVER
HRF 465PD, HRF 465SD	0,6	LR17YC	SUPER	LR17YS	SILVER
HRG 413PD, HRG 413SD		PR17	CLASSIC		
HRG 415C, HRG 465C2, HRG 465CPD, HRG 465CSD		LR15YC	SUPER	LR15YS	SILVER
HRG 465PD, HRG 465SD	0,6	LR17YC	SUPER	LR17YS	SILVER
HRG 536CSD		LR15YC	SUPER	LR15YS	SILVER
HRH 536HX		LR15YC	SUPER	LR15YS	SILVER
HRH 536QX		LR17YC	SUPER	LR17YS	SILVER
HRM 21		N19C	SUPER		
HRM 195PA, HRM 215, HRM 215HXA		LR15YC	SUPER	LR15YS	SILVER
HRM 215PXA, HRM 215SXA, HRM 215K1		LR15YC	SUPER	LR15YS	SILVER
HRM 215K2, HRM 215PDA, HRM 215SDA		LR15YC	SUPER	LR15YS	SILVER
HRM 535SX		LR17YC	SUPER	LR17YS	SILVER
HRM 536C, HRM 536CSX, HRM 536CTX		LR15YC	SUPER	LR15YS	SILVER
HRR 216DPA, HRR 216SDA, HRR 216S3DA		LR15YC	SUPER	LR15YS	SILVER
HRR 216K2PDA, HRR 216K2SDA, HRR 216K2TDA		LR15YC	SUPER	LR15YS	SILVER
HRS 21 CDI (-2029058)		N19C	SUPER		
HRS 21 Std.-Ing (-2029058)		N17YC	SUPER		
HRS 21 CDI (2029059-)		PR17Y	CLASSIC	PR17YC	SUPER
HRS 21 Std.-Ing (2029059-)		P17	CLASSIC		
HRS 216PDA, HRS 216SDA		LR15YC	SUPER	LR15YS	SILVER
HRS 216K2PDA, HRS 216K2SDA		LR15YC	SUPER	LR15YS	SILVER
HRS 535CSD		LR15YC	SUPER	LR15YS	SILVER
HRT 216SDA, HRT 216S3DA		LR15YC	SUPER	LR15YS	SILVER
HRT 216K2TDA		LR17YC	SUPER	LR17YS	SILVER
HRX 217HMA, HRX 217HXA, HRX 217TDA		LR17YC	SUPER	LR17YS	SILVER
HRX 426C PD, HRX 426CPX, HRX 426CQX		LR15YC	SUPER	LR15YS	SILVER
HRX 426CSD		LR15YC	SUPER	LR15YS	SILVER
HRX 476CHX, HRX 476CPX, HRX 476CQX		LR15YC	SUPER	LR15YS	SILVER
HRX 476CSD, HRX 476CSX		LR15YC	SUPER	LR15YS	SILVER



STANDARD
BRISK

ALTERNATIVE
BRISK

HONDA

MOTOROVÉ TRAVNÍ SEKAČKY • LAWN MOWER • СЕНОКОСИЛКИ

HRX 537CHM, HRX 537CHX, HRX 537CTD		LR15YC	SUPER	LR15YS	SILVER
HRX 537C VYE		LR15YC	SUPER	LR15YS	SILVER
HRZ 216TDA, HRZ 536CTD		LR15YC	SUPER	LR15YS	SILVER
HT3810		P17	CLASSIC		
HT3813, HT 4213		NR17YC	SUPER		
HT 4518H		LR17YC-1	SUPER	LR17YS-9	SILVER
HTR 3009, 3811		LR17YC	SUPER	LR17YS	SILVER
RT 5000		LR17YC	SUPER	LR17YS	SILVER
UM 17		PR17	CLASSIC		
UM 21		LR17YC	SUPER	LR17YS	SILVER
UM 24, UM 28	0,6	LR17YC	SUPER	LR17YS	SILVER
UM 516C		LR15YC	SUPER	LR15YS	SILVER
UM 536, UM 536B	0,5	LR17YC	SUPER	LR17YS	SILVER
UM 536EBE, UM 536 EE	0,6	LR17YC	SUPER	LR17YS	SILVER
UM 616, UM 616B	0,5	LR17YC	SUPER	LR17YS	SILVER
UM 616EBE, UM 616EE	0,6	LR17YC	SUPER	LR17YS	SILVER
UM 2160, UM 2160B		LR17YC	SUPER	LR17YS	SILVER
UM 2460, UM 2460B		LR17YC	SUPER	LR17YS	SILVER
UMK 422LNA, UMK 422LTA, UMK 431LNA		NAR15YS	SILVER		
UMK 431LTA, UMK 431UNA, UMK 431UNBA		NAR15YS	SILVER		

HUSQVARNA

FOUKAČE • BLOWERS • ВОЗДУХОДУВКИ

125B, 125BVx	0,5	PR15Y	CLASSIC	PR17YC	SUPER
356BTx	0,5	PR15Y	CLASSIC	PR17YC	SUPER
380BTS		TR14C	SUPER	TR14S	SILVER
580BTS		TR14C	SUPER	TR14S	SILVER

KŘOVINOŘEZY • BRUSH CUTTERS • ТРИММЕРЫ

16H, 18H, 24H, 26H, 26RJ	0,5	PR15	CLASSIC		
16R, 22R, 25R	0,5	P17	CLASSIC		
18R, 18RL, 22RL, 24R, 25RL	0,5	PR17	CLASSIC		
23LC, 26L, 26LC, 32L, 32R	0,5	PR18Y	CLASSIC		
25GT, 27GTS	0,5	P17	CLASSIC		
26R, 65R	0,5	PR15Y	CLASSIC	PR17YC	SUPER
36R, 36RG, 39R	0,5	PR18Y	CLASSIC		
46MR		JR19	CLASSIC		
120L, 140R, 165R, 225H, 225L, 225LD	0,5	PR17Y	CLASSIC	PR17YC	SUPER
122C, 129C		SR15C	SUPER		
122L, 125L, 125LD, 125LDx, 125R		PR18Y	CLASSIC		
125RB, 125RD, 125RJ, 125RL		PR18Y	CLASSIC		
128C, 128R	0,5	PR18Y	CLASSIC		
132L, 132LD, 132R		PR18Y	CLASSIC		
132HBV	0,5	PR17	CLASSIC		
132RB, 132RD	0,5	PR18Y	CLASSIC		
135R	0,5	PR15Y	CLASSIC	PR17YC	SUPER
165RX, 225R, 225RD, 225RJ, 225RT	0,5	PR17Y	CLASSIC	PR17YC	SUPER
232L, 232L CAT, 232R CAT, 232R	0,5	PR17Y	CLASSIC	PR17YC	SUPER
235P, 235R, 235R CAT, 240R, 240RBD	0,5	PR17Y	CLASSIC	PR17YC	SUPER
244GX	0,5	PR18Y	CLASSIC		
244R, 244RX, 244RXG, 245R, 245RX	0,5	PR17Y	CLASSIC	PR17YC	SUPER
250PS, 250R, 250RX, 265RX	0,5	PR17Y	CLASSIC	PR17YC	SUPER
268K	0,5	PR18Y	CLASSIC		
323C, 323E, 323EX, 323L, 323R II	0,5	PR15Y	CLASSIC	PR17YC	SUPER
324HE	0,5	PR17Y	CLASSIC	PR17YC	SUPER
324RX		TR17	CLASSIC	TR17C	SUPER
325, 325C, 325CX, 325EX, 325HDA	0,5	PR17Y	CLASSIC	PR17YC	SUPER
325HS, 325L, 325LX, 325P, 325RX, 325RJX	0,5	PR17Y	CLASSIC	PR17YC	SUPER



service
instructions

... BOSCH ...
... CHAMPION ...
... NGK ...



BRISK

LAST INFO

**STANDARD
BRISK**
**ALTERNATIVE
BRISK**
HUSQVARNA
KŘOVINOŘEZY • BRUSH CUTTERS • ТРИММЕРЫ

326HD, 326HDA, 326HE, 326HS, 326LXE	0,5	PR17Y	CLASSIC	PR17YC	SUPER
326L, 326LX, 326LDx	0,5	PR15Y	CLASSIC	PR17YC	SUPER
326P, 326RX	0,5	PR17Y	CLASSIC	PR17YC	SUPER
327LDx, 327RDX, 327RX	0,5	PR15Y	CLASSIC	PR17YC	SUPER
335FR, 335Rx, 343F, 345Fx, 345Rx	0,5	PR15Y	CLASSIC	PR17YC	SUPER
535Rjx, 535Rx, 535RxT	0,5	PR15Y	CLASSIC	PR17YC	SUPER
545Fx, 545FxT X-Torq		TR15C	SUPER		
545Rx, 545RxT		TR15C	SUPER		
555Fx X-Torq, 555RxT	0,5	PR15Y	CLASSIC	PR17YC	SUPER
HVT 40	0,5	PR18Y	CLASSIC		
HVT 52		JR17	CLASSIC		
HVT 1200, HVT 1500, HVT 2000		JR17	CLASSIC		
Mondo, Mondo Max, Mondo Mega	0,5	P18Y	CLASSIC		

KULTIVÁTORY • CULTIVATORS • КУЛЬТИВАТОРЫ

22HB, 28HBV, 40B		PR17Y	CLASSIC	PR17YC	SUPER
25H, 26H		P17	CLASSIC		
122HB, 132HBV		PR18Y	CLASSIC		
140B, 225HBV		P17	CLASSIC		
145BF, 145BT, 155BT, 165BT, 225B, 225BX		PR15Y	CLASSIC	PR17YC	SUPER
225E, 235P, 250PS, 272S		PR17Y	CLASSIC	PR17YC	SUPER
268K, 272K, 371K		PR18Y	CLASSIC		
325LX		P17	CLASSIC		
550CRTH		LR17YC	SUPER	LR17YS	SILVER
550CRTT		L15C	SUPER	LR15S	SILVER
650CRT	0,5	DR17YC	SUPER	DR17YS	SILVER
3120K		PR18Y	CLASSIC		
B & S - 3,5 HP - AR 19B, AR 25B		JR19	CLASSIC		
B & S - 5,5 HP - DT 18B, SD 18B / Intek	0,5	DR17YC	SUPER	DR17YS	SILVER
CRT 35, CRT 50, CRT 51		JR19	CLASSIC		
CRT 52, CRT 55, CRT 81, CRT 83		JR19	CLASSIC		
CRT 61		L15C	SUPER	LR15S	SILVER
CT 16A, CT 20A	0,8	PR18Y	CLASSIC		
Honda - 4 HP - AR 19		LR15YC	SUPER	LR15YS	SILVER
Honda - 4 HP - AR 19H, AR 25H		LR17YC	SUPER	LR17YS	SILVER
Honda - 4,9 HP - DT 22 (Honda GX160)		LR15YC	SUPER	LR15YS	SILVER
Honda - 5,5 HP - DT 18H, SD 18H, SC 18H		LR17YC	SUPER	LR17YS	SILVER
Honda - 11,8 HP - SG 13 (Honda GX)		LR15YC	SUPER	LR15YS	SILVER
Honda - 13 HP (OHV)		LR17YC	SUPER	LR17YS	SILVER
LE 309, LE 359, LE 389, LE 389HD		JR19	CLASSIC		
T 50RS		NR15C	SUPER	NR15S	SILVER
T 225R, T 250, T 255, T 255R		JR19	CLASSIC		
T 300, T 520, T 560		JR19	CLASSIC		

MALOTRAKTORY • TRACTORS • МАЛОГАБАРИТНЫЕ ТРАКТОРЫ

5,5 HP, 9 HP		LR15YC	SUPER	LR15YS	SILVER
B & S - 6 HP, 8 HP, 10 HP, 11 HP, 23 HP	0,6	JR19	CLASSIC		
CT 126		DR17YC	SUPER	DR17YS	SILVER
CTH 126, CTH 173		DR17YC	SUPER	DR17YS	SILVER
CTH 163 TWIN, CTH 182 TWIN	6	A-line		LR17YS	SILVER
CTH 222 TWIN, CTH 224 TWIN	6	A-line		LR17YS	SILVER
GTH 263 TWIN	6	A-line		LR17YS	SILVER
GTH 255A, GTH 275A		DR17YC	SUPER	DR17YS	SILVER
Iron Horse		PR17Y	CLASSIC	PR17YC	SUPER
LT 110, LT 112, LT 120		JR19	CLASSIC		
LT 960-12		JR19	CLASSIC		
LT 1000-14 (OHV)		DR17YC	SUPER	DR17YS	SILVER
LT 4140G, LT 4140H / OHV		DR17YC	SUPER	DR17YS	SILVER



**STANDARD
BRISK**

**ALTERNATIVE
BRISK**

HUSQVARNA

MALOTRAKTORY • TRACTORS • МАЛОГАБАРИТНЫЕ ТРАКТОРЫ

LTH 151		DR17YC	SUPER	DR17YS	SILVER
LTH 18542, LTH 2245		DR17YC	SUPER	DR17YS	SILVER
YTH 1120-14		N17C	SUPER		
YTH 1942, YTH 2348		DR17YC	SUPER	DR17YS	SILVER

MOTOROVÉ PÍLY • CHAINSAW • МОТОПИЛЫ

1R, 16, 18, 22R, 22RL, 24, 25RL	0,5	PR17Y	CLASSIC	PR17YC	SUPER
26RCL, 32, 32R, 32RCL, 33	0,5	PR17Y	CLASSIC	PR17YC	SUPER
36, 36R, 38, 39, 40, 41, 42, 42D, 44, 45	0,5	PR17Y	CLASSIC	PR17YC	SUPER
40P, 44P, 50-PS	0,5	P18Y	CLASSIC		
51, 55, 55D, 61, 61D, 61P	0,5	PR17Y	CLASSIC	PR17YC	SUPER
65, 65A, 65B, 65F, 65G, 65K, 65L, 65R, 66	0,5	PR17Y	CLASSIC	PR17YC	SUPER
70A, 70F, 77, 77A, 77B, 77L, 77S, 77SS	0,5	PR17Y	CLASSIC	PR17YC	SUPER
100A	0,5	PR17Y	CLASSIC	PR17YC	SUPER
133SE, 133SG	0,5	PR17Y	CLASSIC	PR17YC	SUPER
136, 140, 140R, 140S, 141	0,5	PR17Y	CLASSIC	PR17YC	SUPER
154, 154SE, 154SG, 160CD, 160S, 160SG	0,5	PR17Y	CLASSIC	PR17YC	SUPER
162E, 162FE, 162FG, 162S, 162SE, 162SG	0,5	PR17Y	CLASSIC	PR17YC	SUPER
163CD, 163CS, 163S, 163SE	0,5	PR17Y	CLASSIC	PR17YC	SUPER
165, 165R, 165RX, 180S	0,5	PR17Y	CLASSIC	PR17YC	SUPER
181, 181CD, 181SE, 181SG, 185CD	0,5	PR17Y	CLASSIC	PR17YC	SUPER
234SE, 234SG, 235, 235e, 236, 236e	0,5	PR17Y	CLASSIC	PR17YC	SUPER
238, 238SE, 238SG	0,5	PR17Y	CLASSIC	PR17YC	SUPER
240e, 240S, 240SE, 240SG	0,5	PR17Y	CLASSIC	PR17YC	SUPER
242SP, 242SPG, 242SPG CAT	0,5	PR17Y	CLASSIC	PR17YC	SUPER
242XP, 242XPG	0,5	PR17Y	CLASSIC	PR17YC	SUPER
244, 244R, 245R, 245RX	0,5	PR17Y	CLASSIC	PR17YC	SUPER
246, 246SP	0,5	PR17Y	CLASSIC	PR17YC	SUPER
250PS, 254XP, 254XPG, 257, 257D	0,5	PR17Y	CLASSIC	PR17YC	SUPER
260, 260CD, 261	0,5	PR17Y	CLASSIC	PR17YC	SUPER
262XP, 262XPG, 263CD, 265RX	0,5	PR17Y	CLASSIC	PR17YC	SUPER
266FE, 266FG, 266SE, 266SG, 266XP	0,5	PR17Y	CLASSIC	PR17YC	SUPER
268, 268K, 268XP	0,5	PR17Y	CLASSIC	PR17YC	SUPER
272K, 272S, 272XP, 272XPG	0,5	PR17Y	CLASSIC	PR17YC	SUPER
280CD, 280G, 280S	0,5	PR17Y	CLASSIC	PR17YC	SUPER
281, 281XP, 288XP, 288XPG	0,5	PR17Y	CLASSIC	PR17YC	SUPER
285CD	0,5	PR17Y	CLASSIC	PR17YC	SUPER
327P 5x	0,5	PR15Y	CLASSIC	PR17YC	SUPER
334, 334T, 335XPT, 338, 338XPT, 339, 339XP	0,5	PR17Y	CLASSIC	PR17YC	SUPER
340, 340SE, 340SG, 344FE, 344FG	0,5	PR17Y	CLASSIC	PR17YC	SUPER
345, 346, 346XP, 346XPG	0,5	PR17Y	CLASSIC	PR17YC	SUPER
350, 351, 351G, 353, 357, 357XP, 357XPG, 359	0,5	PR17Y	CLASSIC	PR17YC	SUPER
362XP, 362XPG, 365	0,5	PR17Y	CLASSIC	PR17YC	SUPER
371XP, 371XPG, 372XP, 372XPG	0,5	PR17Y	CLASSIC	PR17YC	SUPER
380CD, 380K, 380S	0,5	PR17Y	CLASSIC	PR17YC	SUPER
385, 385XP, 394XP, 394XPG	0,5	PR15Y	CLASSIC	PR17YC	SUPER
390, 390XP, 395, 395XP	0,5	PR17Y	CLASSIC	PR17YC	SUPER
435, 435e, 440e, 440e TrioBrake	0,5	PR17Y	CLASSIC	PR17YC	SUPER
444, 444FE, 444FG, 444SE, 444SG	0,5	PR15Y	CLASSIC	PR17YC	SUPER
445, 445e, 445e TrioBrake, 450e	0,5	PR17Y	CLASSIC	PR17YC	SUPER
455, 460	0,5	PR17Y	CLASSIC	PR17YC	SUPER
480CD, 480K, 535FBx	0,5	PR15Y	CLASSIC	PR17YC	SUPER
555, 560XP, 560XPG		TR15C	SUPER		
570	0,5	PR17Y	CLASSIC	PR17YC	SUPER
575, 575XP, 575XPG	0,5	PR15Y	CLASSIC	PR17YC	SUPER
576XP, 576XP Autotune, 576XPG	0,5	PR17Y	CLASSIC	PR17YC	SUPER
1100CD, 2100CD, 2100CDW	0,5	PR15Y	CLASSIC	PR17YC	SUPER



service
instructions

... BOSCH ...
... CHAMPION ...
... NGK ...



BRISK

LAST INFO

**STANDARD
BRISK**
**ALTERNATIVE
BRISK**
HUSQVARNA
MOTOROVÉ PILY • CHAINSAW • МОТОПИЛЫ

2101XP, 2405, 3120, 3120XP	0,5	PR17Y	CLASSIC	PR17YC	SUPER
3130	0,5	PR17Y	CLASSIC	PR17YC	SUPER
Husky - 22, 23 Compact, 35, 37	0,5	P15	CLASSIC		
Husky - 32, 33, 34, 35VR, 36, 36R, 38	0,5	PR17Y	CLASSIC	PR17YC	SUPER
Husky - 34D	0,5	U17	CLASSIC		
Husky - 38VR, 39R, 40, 41, 42, 44, 45, 49	0,5	PR17Y	CLASSIC	PR17YC	SUPER
Husky - 50, 51, 55, 55 Rancher, 61, 65	0,5	PR17Y	CLASSIC	PR17YC	SUPER
Husky - 65A, 65B, 66, 77, 77A, 246	0,5	PR17Y	CLASSIC	PR17YC	SUPER
Rancher 40, Rancher 50, Rancher 61	0,5	PR18Y	CLASSIC		
Rancher 455e, Rancher 460	0,5	PR17Y	CLASSIC	PR17YC	SUPER
T 425	0,5	PR17Y	CLASSIC	PR17YC	SUPER
T 435		TR14C	SUPER	TR14S	SILVER

MOTOROVÉ PLOTOSTŘÍHY • HEDGE TRIMMERS • КУСТОРЕЗЫ

226HD 75S		TR14C	SUPER	TR14S	SILVER
325HD 60X II, 325HD 75X II	0,5	PR17Y	CLASSIC	PR17YC	SUPER
325HE 3X	0,5	PR15Y	CLASSIC	PR17YC	SUPER

MOTOROVÉ TRAVNÍ SEKAČKY • LAWN MOWER • СЕНОКОСИЛКИ

50DK, 51		JR19	CLASSIC		
51MDT		K19	CLASSIC		
56D, 56DHS, 56H, 56HS		JR19	CLASSIC		
56HT, 56HTS		K19	CLASSIC		
56SF, 56SFE		JR19	CLASSIC		
510MDT		L15C	SUPER	LR15S	SILVER
510, 510MD, 560H, 560HS, 560SR		DR17YC	SUPER	DR17YS	SILVER
560HH, 560HSH		LR15YC	SUPER	LR15YS	SILVER
560HT, 560HST		L15C	SUPER	LR15S	SILVER
580BBC, 580R, 580SE, 580RSE, 580RSW		DR17YC	SUPER	DR17YS	SILVER
600C		DR17YC	SUPER	DR17YS	SILVER
6020MD, 6022CH, 6022SH		JR19	CLASSIC		
6521RS, 6522CH, 6522SH		DR17YC	SUPER	DR17YS	SILVER
B & S - 3,75 HP, 4 HP, 4,5 HP, 5 HP		JR19	CLASSIC		
B & S - 5,5 HP, 6 HP, 7 HP		JR19	CLASSIC		
B & S - 6 HP, 6,5 HP (OHV - Intek)	0,5	DR17YC	SUPER	DR17YS	SILVER
Honda - 4,5 HP (GCV 135)		LR15YC	SUPER	LR15YS	SILVER
Honda - 4,8 HP (GX 160)		LR15YC	SUPER	LR15YS	SILVER
Honda - 5 HP (OHV)		LR15YC	SUPER	LR15YS	SILVER
Honda - 5,5 HP (GCV 160)		LR15YC	SUPER	LR15YS	SILVER
Kawasaki - 6 HP (FJ 180V)		LR17YC	SUPER	LR17YS	SILVER
Kawasaki - 15 HP (FH 430V, FH 451V)		PR18Y	CLASSIC		
Kawasaki - 17 HP (FH 500V, FH 541V)		PR18Y	CLASSIC		
Kawasaki - 18 HP (FH 531V)		PR18Y	CLASSIC		
Kawasaki - 19 HP (FH 580V)		PR18Y	CLASSIC		
Kawasaki - 19 HP (FH 601V)	6	A-line		LR17YS	SILVER
Kawasaki - 21 HP (FH 641V)	6	A-line		LR17YS	SILVER
Kawasaki - 22 HP (FH 661V)	6	A-line		LR17YS	SILVER
Kawasaki - 23 HP (FH 680V)	6	A-line		LR17YS	SILVER
Kawasaki - 25 HP (FH 721V)	6	A-line		LR17YS	SILVER
Kohler - CV 11, CV 12,5, CV 14, CV 15, CV 16		DR17YC	SUPER	DR17YS	SILVER
Kohler - CV 460-493		DR17YC	SUPER	DR17YS	SILVER
Kohler - Command		DR17YC	SUPER	DR17YS	SILVER
Kohler - Courage		DR17YC	SUPER	DR17YS	SILVER
Kohler - SV 470, SV 480, SV 530		DR17YC	SUPER	DR17YS	SILVER
Kohler - SV 540, SV 590, SV 600		DR17YC	SUPER	DR17YS	SILVER
Landscaper - 2T, 4T, 5AT		JR19	CLASSIC		
LC 48V, LC 48VE		JR19	CLASSIC		
LC 48e, LC 53Be, LC 53e, LC 53Ee		DR17YC	SUPER	DR17YS	SILVER



HUSQVARNA

MOTOROVÉ TRAVNÍ SEKAČKY • LAWN MOWER • СЕНОКОСИЛКИ

M 145SV		JR19	CLASSIC		
Master - 46, 46 Garden, 46S		JR19	CLASSIC		
Master - PRO 2T, PRO 4T,		JR19	CLASSIC		
Master - PRO S4T, PRO SCAT		JR19	CLASSIC		
Push Mowers		JR19	CLASSIC		
Tecumseh - 2 HP, 35 HP		JR17	CLASSIC		
Tecumseh - 6 HP		K19	CLASSIC		
Tecumseh - 6 HP (OHV)		L15C	SUPER	LR15S	SILVER
R 52S, R 145, R 145SV		JR19	CLASSIC		
R 150SV, R 152SV, R 152SV Swivel		DR17YC	SUPER	DR17YS	SILVER
R 152SVH		LR15YC	SUPER	LR15YS	SILVER
Rider - 15Ts AWD		PR18Y	CLASSIC		
Rider - 16C, 16C AWD		DR17YC	SUPER	DR17YS	SILVER
Rider - 17 Pro AWD		6	A-line	LR17YS	SILVER
Rider - 21 Proflex AWD		6	A-line	LR17YS	SILVER
Rider - 111B		DR17YC	SUPER	DR17YS	SILVER
Rider - 216 AWD		DR17YC	SUPER	DR17YS	SILVER
Rider - 650	0,6	JR17	CLASSIC		
Rider - 650-6		K19	CLASSIC		
Rider - 820-8		JR19	CLASSIC		
Rider - 850-10, 850-12		JR19	CLASSIC		
Rider - 970-12, 970-12R, 970-12S		JR19	CLASSIC		
Rider - 970-15, 970-12S, 970H-15S		JR19	CLASSIC		
Rider - 980H15-B		JR19	CLASSIC		
Rider - 1000-14, 1200-18	0,6	LR17YC	SUPER	LR17YS	SILVER
Rider - 1200-14		JR19	CLASSIC		
Rider - 1200-18H		DR17YC-9	SUPER	DR17YS-9	SILVER
Rider - GT 200		DR17YC-9	SUPER	DR17YS-9	SILVER
Rider - GTH 200, GTH 220,		DR17YC-9	SUPER	DR17YS-9	SILVER
Rider - GTH 2250, GTH 2550		DR17YC	SUPER	DR17YS	SILVER
Rider - LR 110, LR 120, LR 121		JR19	CLASSIC		
Rider - LT 10Q, LT 100, LT 112		JR19	CLASSIC		
Rider - LT 120, LT 125, LT 130		JR19	CLASSIC		
Rider - LT 1538		DR17YC-9	SUPER	DR17YS-9	SILVER
Rider - LT 960-12, LT 4140G, LT 4140H	0,6	JR17	CLASSIC		
Rider - LTH 120		JR19	CLASSIC		
Rider - LTH 130, LTH 145, LTH 1742		DR17YC-9	SUPER	DR17YS-9	SILVER
Rider - PRO 14		DR17YC	SUPER	DR17YS	SILVER
Rider - PRO 15		PR18Y	CLASSIC		
Rider - PRO 21 Flex		JR19	CLASSIC		
Rider - B & S - 8,5 HP, 10 HP, 11 HP, 12 HP		JR19	CLASSIC		
Rider - B & S - 12,5 HP, 13 HP		JR19	CLASSIC		
Rider - B & S - 14,5 HP (OHV)		DR17YC	SUPER	DR17YS	SILVER
Rider - B & S - 15,5 HP, 17 HP, 20 HP (Intek)		DR17YC	SUPER	DR17YS	SILVER
Rider - B & S - 22 HP, 25 HP (Intek)		DR17YC	SUPER	DR17YS	SILVER
Rider - B & S - 13 HP, 16 HP (Vanguard)		DR17YC	SUPER	DR17YS	SILVER
Rider - B & S - 18 HP, 20 HP (Vanguard / V-Twin)		DR17YC	SUPER	DR17YS	SILVER
Rider - Kawasaki - 12,5 HP		P17	CLASSIC		
Rider - Kawasaki - 17 HP (OHV / V-Twin)		PR18Y	CLASSIC		
Rider - Kawasaki - 14 HP, 18 HP (OHV)		LR17YC	SUPER	LR17YS	SILVER
Rider - Kawasaki - 21 HP, 23 HP, 25 HP (OHV)		LR17YC	SUPER	LR17YS	SILVER
Rider - Kawasaki - 27 HP		LR17YC	SUPER	LR17YS	SILVER
Rider - Kohler - 12,5 HP, 13 HP (OHV)		DR17YC-9	SUPER	DR17YS-9	SILVER
Rider - Kohler - 14 HP, 15 HP (OHV)		DR17YC-9	SUPER	DR17YS-9	SILVER
Rider - Kohler - 18 HP, 20 HP (V-Twin)		DR17YC	SUPER	DR17YS	SILVER
Rider - Kohler - 22 HP, 25 HP (V-Twin)		DR17YC	SUPER	DR17YS	SILVER



service
instructions

... BOSCH ...
... CHAMPION ...
... NGK ...



BRISK

LAST INFO



**STANDARD
BRISK**

**ALTERNATIVE
BRISK**

HUSQVARNA

MOTOROVÉ TRAVNÍ SEKAČKY • LAWN MOWER • СЕНОКОСИЛКИ

Rider - Kohler - 23 HP (Aegis)		DR17YC	SUPER	DR17YS	SILVER
Rider - Kohler - 26 HP (V-Twin) EFI		DR17YC	SUPER	DR17YS	SILVER
Rider - Kohler - 28 HP		DR17YC	SUPER	DR17YS	SILVER
Rider - YT 180		DR17YC-9	SUPER	DR17YS-9	SILVER
Rider - YTH 150, YTH 160, YTH 180		DR17YC-9	SUPER	DR17YS-9	SILVER
Rider - YTH 1120-14		DR17YC-9	SUPER	DR17YS-9	SILVER
Rider - YTH 1542, YTH 1746, YTH 1842		DR17YC-9	SUPER	DR17YS-9	SILVER
Rider - YTH 1542XP		LR17YC	SUPER	LR17YS	SILVER
Rider - YTH 1848XP		LR17YC	SUPER	LR17YS	SILVER
Rider - YTH 2046, YTH 2048, YTH 2242		DR17YC-9	SUPER	DR17YS-9	SILVER
Royal - 42, 42S, 43, 43S, 43SE		JR19	CLASSIC		
Royal - 46, 46ST, 47S, 48, 48S, 48SE		JR19	CLASSIC		
Royal - 48SEK, 48SK, 53SEK	0,6	LR15YC	SUPER	LR15YS	SILVER
Royal - 53S, 53SE		JR19	CLASSIC		
Royal - 425		JR19	CLASSIC		
Royal - 535, 535E, 535SEK	0,6	LR15YC	SUPER	LR15YS	SILVER
Royal - 820-8		J19	CLASSIC		
Royal - Classic		JR19	CLASSIC		
Royal - Jet 46K, Jet 46R, Jet 48,		JR19	CLASSIC		
Royal - Jet 48KD, Jet 49 Husky, Jet 50		JR19	CLASSIC		
Royal - Jet 50R, Jet 51, Jet 55S		JR19	CLASSIC		
SC 18		LR15YC	SUPER	LR15YS	SILVER
W 53CS, W 53CSB		LR17YC	SUPER	LR17YS	SILVER
WB 53Se		LR15YC	SUPER	LR15YS	SILVER
WC 48Se		DR17YC	SUPER	DR17YS	SILVER

HYDRA-SPLITTER

MOTOROVÉ PÍLY • CHAINSAW • МОТОПИЛЫ

B & S		J19	CLASSIC		
-------	--	-----	---------	--	--

CHICAGO PNEUMATIC

MALOTRAKTORY • TRACTORS • МАЛОГАБАРИТНЫЕ ТРАКТОРЫ

250 RG-2	0,6	N17C	SUPER		
----------	-----	------	-------	--	--

CHIEF

MOTOROVÉ PÍLY • CHAINSAW • МОТОПИЛЫ

D 15		P17	CLASSIC		
D 35		K19	CLASSIC		
E 75, E 95		P17	CLASSIC		

CHRYSLER

ELEKTROCENTRÁLY / STACIONÁRNÍ MOTORY • ELEKTROCENTRALS / STATIONARY ENGINES • ЭЛЕКТРИЧЕСКИЕ КОММУТАТОРЫ / СТАЦИОНАРНЫЕ ДВИГАТЕЛИ

Light Service

H 170, H 225		LR17YC-9	SUPER	LR17YS-9	SILVER
H 440	0,9	K17Y	CLASSIC		
HB 170, HB 225 (-1974)		LR17YC-9	SUPER	LR17YS-9	SILVER
IND 54	0,9	K17Y	CLASSIC		
LH 318		LR17YC-9	SUPER	LR17YS-9	SILVER

ELEKTROCENTRÁLY / STACIONÁRNÍ MOTORY • ELEKTROCENTRALS / STATIONARY ENGINES • ЭЛЕКТРИЧЕСКИЕ КОММУТАТОРЫ / СТАЦИОНАРНЫЕ ДВИГАТЕЛИ

Normal Service

H 105 (1978)	0,6	LR15YC	SUPER	LR15YS	SILVER
H 170, H 225	0,9	L17C	SUPER		
H 273		LR17YC-9	SUPER	LR17YS-9	SILVER
H 318, H 440	0,9	K15YC	SUPER		
H 361, H 383, H 413, HA 318	0,9	K17Y	CLASSIC		
HB 170, HB 225 (-1974)	0,9	L17C	SUPER		
HB 318	0,9	K15YC	SUPER		
HB 361, HB 383, HB 413, HB 426	0,9	L17C	SUPER		
HC 318	0,9	K15YC	SUPER		
HC 361, HC 413, HC 426	0,9	L17C	SUPER		



CHRYSLER

ELEKTROCENTRÁLY / STACIONÁRNÍ MOTORY • ELEKTROCENTRALS / STATIONARY ENGINES • ЭЛЕКТРИЧЕСКИЕ КОММУТАТОРЫ / СТАЦИОНАРНЫЕ ДВИГАТЕЛИ

Normal Service

HT 318	0,9	K15YC	SUPER	
HT 361, HT 413	0,9	L17C	SUPER	
IND 5A, IND 6A, IND 7	0,9	K19	CLASSIC	
IND 8A, IND 13, IND 13A, IND 14, IND 14A, IND 15	0,9	K19	CLASSIC	
IND 15A, IND 16A, IND 30	0,9	K19	CLASSIC	
IND 18A, IND 19A, IND 20A	0,9	K19	CLASSIC	
IND 31, IND 32, IND 33	0,9	K19	CLASSIC	
IND 38, IND 908A, IND 931	0,9	K19	CLASSIC	
L 360 (1977-1978)		LR17YC-9	SUPER	LR17YS-9 SILVER
LH 318, LH 360 (1977-1978)		LR17YC-9	SUPER	LR17YS-9 SILVER

ELEKTROCENTRÁLY / STACIONÁRNÍ MOTORY • ELEKTROCENTRALS / STATIONARY ENGINES • ЭЛЕКТРИЧЕСКИЕ КОММУТАТОРЫ / СТАЦИОНАРНЫЕ ДВИГАТЕЛИ

Severe Service

H 440	0,9	K15YC	SUPER	
IND 5A, IND 6A, IND 7A, IND 8A	0,5	K19	CLASSIC	
IND 13, IND 13A, IND 14, IND 14A, IND 15, IND 15A, IND 16A	0,5	K19	CLASSIC	
IND 30, IND 31, IND 32, IND 33	0,5	K19	CLASSIC	
IND 38, IND 908A, IND 931	0,5	K19	CLASSIC	

CHRYSLER POWER BEE

ELEKTROCENTRÁLY / STACIONÁRNÍ MOTORY • ELEKTROCENTRALS / STATIONARY ENGINES • ЭЛЕКТРИЧЕСКИЕ КОММУТАТОРЫ / СТАЦИОНАРНЫЕ ДВИГАТЕЛИ

2 HP -50056	0,8	P17	CLASSIC	
3 HP -51001	0,8	K19	CLASSIC	
3,3 HP -50052, 50054	0,8	P17	CLASSIC	
4 HP -58021, 58037	0,8	K19	CLASSIC	
4,25 HP -50000, 50002, 50004	0,8	P17	CLASSIC	
4,25 HP -50006, 50012, 50014	0,8	P17	CLASSIC	
4,7 HP -61010	0,8	NR15C	SUPER	NR15S SILVER
5,5 HP -61005, 61006		N17C	SUPER	
7,5 HP -61001, 61002		N15C	SUPER	NR15S SILVER
8 HP -61012		N15C	SUPER	NR15S SILVER
6,2 HP -82005, 82009, 82017		N17C	SUPER	
6,2 HP -82019, 82021, 82023		N17C	SUPER	
6,2 HP -82006		N15C	SUPER	NR15S SILVER
6,5 HP -82008, 82010		N17C	SUPER	
6,7 HP -82007, 82011, 82029, 82031		N17C	SUPER	
7 HP -82003		N15C	SUPER	NR15S SILVER
7 HP -82026, 82027, 82030		N17C	SUPER	
7 HP -82032, 82033, 82034, 82036		N17C	SUPER	
10 HP -82001, 82002, 82038, 82039		N15C	SUPER	NR15S SILVER

IH

MALOTRAKTORY • TRACTORS • МАЛОГАБАРИТНЫЕ ТРАКТОРЫ

444 (C-153)	0,6	N19C	SUPER	
-------------	-----	------	-------	--

INDIAN

MOTOROVÉ PÍLY • CHAINSAW • МОТОПИЛЫ

5-12 Std., 5-12 Super		P17	CLASSIC	
547H		P17	CLASSIC	
561H, 582H		N15C	SUPER	NR15S SILVER

INTERNATIONAL

ELEKTROCENTRÁLY / STACIONÁRNÍ MOTORY • ELEKTROCENTRALS / STATIONARY ENGINES • ЭЛЕКТРИЧЕСКИЕ КОММУТАТОРЫ / СТАЦИОНАРНЫЕ ДВИГАТЕЛИ

Light Service

RV 549	0,8	K15YC	SUPER	
U 220, U240, U 269, U 282, U 308	0,8	K15YC	SUPER	
U 450, U 501	0,8	K15YC	SUPER	
UB 220, UB 240, UB 264, UB 308	0,8	K15YC	SUPER	
UR 501, UR 372, UR 450	0,8	K15YC	SUPER	
UV 266, UV 304, UV 345, UV 392	0,8	K15YC	SUPER	



service instructions

... BOSCH ...
... CHAMPION ...
... NGK ...



LAST INFO



STANDARD
BRISK

ALTERNATIVE
BRISK

INTERNATIONAL

ELEKTROCENTRÁLY / STACIONÁRNÍ MOTORY • ELEKTROCENTRALS / STATIONARY ENGINES • ЭЛЕКТРИЧЕСКИЕ КОММУТАТОРЫ / СТАЦИОНАРНЫЕ ДВИГАТЕЛИ

Light Service

UV 401, UV 461 0,8 K15YC SUPER

ELEKTROCENTRÁLY / STACIONÁRNÍ MOTORY • ELEKTROCENTRALS / STATIONARY ENGINES • ЭЛЕКТРИЧЕСКИЕ КОММУТАТОРЫ / СТАЦИОНАРНЫЕ ДВИГАТЕЛИ

Normal Service

C-446 0,9 G17YC SUPER GR17YS SILVER

C-537,C-605 LR17YC SUPER LR17YS SILVER

UB 240 0,8 K17C SUPER

UR 372 0,8 K17C SUPER

UV 266, UV 304, UV 345, UV 392 0,8 K17C SUPER

ELEKTROCENTRÁLY / STACIONÁRNÍ MOTORY • ELEKTROCENTRALS / STATIONARY ENGINES • ЭЛЕКТРИЧЕСКИЕ КОММУТАТОРЫ / СТАЦИОНАРНЫЕ ДВИГАТЕЛИ

Severe Service

C-446 0,9 GR15YC SUPER GR15YS-9 SILVER

U 220, U 240, U 269, U 282 0,8 K17C SUPER

U 308, U 372, U 450, U 501 0,8 K17C SUPER

UB 220, UB 240, UB 264, UB 308 0,8 K17C SUPER

UR 501, UR 372, UR 450 0,8 K17C SUPER

UV 266, UV 304, UV 345 0,8 K17C SUPER

UV 392, UV 401, UV 461, UV 549 0,8 K17C SUPER

MOTOROVÉ TRAVNÍ SEKAČKY • LAWN MOWER • СЕНОКОСИЛКИ

B & S J19 CLASSIC

IRUS

MALOTRAKTORY • TRACTORS • МАЛОГАБАРИТНЫЕ ТРАКТОРЫ

U 1200, U 1200K / (MAG-1040 SRL) 0,5 N19C SUPER

ISEKI

KULTIVÁTORY • CULTIVATORS • КУЛЬТИВАТОРЫ

All models - 2Takt / 4Takt K19 CLASSIC

AC 1, AC 2 0,6 N17C SUPER

KC 2, KC 2F, KC 4, KC 4F, KC 450C 0,6 N17C SUPER

KS 250, KS 280 0,6 N17C SUPER

KT 500, KT 600 0,6 N17C SUPER

MC 1 0,6 N17C SUPER

ISHIKAWAJIMA

ELEKTROCENTRÁLY / STACIONÁRNÍ MOTORY • ELEKTROCENTRALS / STATIONARY ENGINES • ЭЛЕКТРИЧЕСКИЕ КОММУТАТОРЫ / СТАЦИОНАРНЫЕ ДВИГАТЕЛИ

BEF 8, BEF 10, BEF 13, BEF 15, BEF 15RE P17 CLASSIC

GE 13, GE 18, GE 22, GE 25, GE 35, GE 43 K19 CLASSIC

GE 18B, GE 18BR N17C SUPER

GED 13, GED 15, GED 18 N17C SUPER

GED 19R, GED 19RE, GED 19S, GED 19SE N17C SUPER

GED 20, GED 21, GED 22, GED 25, GED 30, GED 35 N17C SUPER

GED 25R, GED 25S, GED 30R, GED 30S N17YC SUPER

GEF 13, GEF 15, GEF 18 N17C SUPER

GEF 18R, GEF 20R P17 CLASSIC

GEF 20, GEF 22, GEF 25, GEF 30 N17C SUPER

HED 60R N17C SUPER

KE 22, KE 25, KE 43 P17Y CLASSIC PR17YC SUPER

KE 35A K19 CLASSIC

KED 20, KED 22, KED 25, KED 30, KED 60R N17C SUPER

KEF 15, KEF 18 N17C SUPER

TEA 0660 N17C SUPER

TEB 0110, TEB 0125, TEB 0211, TEB 0411 P17 CLASSIC

TEB 0310, TEB 0410 N17C SUPER

KŘOVINOŘEZY • BRUSH CUTTERS • ТРИММЕРЫ

H 18D, H 20D, H 23D, H 26D, H 35D PR17Y CLASSIC PR17YC SUPER

SB 19, SB 24, SB 30, SB 40 P17 CLASSIC

SCK 30D P17 CLASSIC

SCY 24, SCY 24A P17 CLASSIC



STANDARD
BRISK

ALTERNATIVE
BRISK

IVECO

MALOTRAKTORY • TRACTORS • МАЛОГАБАРИТНЫЕ ТРАКТОРЫ

B 20C, B 25C, B 30C L15YC SUPER LR15YS SILVER

JIM SAVAGE

MOTOROVÉ PÍLY • CHAINSAW • МОТОПИЛЫ

100 Super P17 CLASSIC
350 Maxi P17 CLASSIC
580 Pro P17 CLASSIC

JOBU

ELEKTROCENTRÁLY / STACIONÁRNÍ MOTORY • ELEKTROCENTRALS / STATIONARY ENGINES • ЭЛЕКТРИЧЕСКИЕ КОММУТАТОРЫ / СТАЦИОНАРНЫЕ ДВИГАТЕЛИ

Junior 0,4 N19C SUPER
Senior 0,5 N14C SUPER NR14S SILVER

KŘOVINOŘEZY • BRUSH CUTTERS • ТРИММЕРЫ

Companion 0,5 P17 CLASSIC
R 50 0,5 U15 CLASSIC

MOTOROVÉ PÍLY • CHAINSAW • МОТОПИЛЫ

L 6, L 7, L 8, L 73, L 81 0,5 PR17Y CLASSIC PR17YC SUPER
L 86-6, L 86B, L 86S, L 860 0,5 PR17Y CLASSIC PR17YC SUPER
LF 50, LF 50B 0,5 U15 CLASSIC
LP 5, LP 5BS, LP 6 0,5 U15 CLASSIC
LP 6B, LP 6BV 0,5 U15 CLASSIC
M 5 0,5 N15YC SUPER
Micro 25, Micro 25CVA P17 CLASSIC
R 7 0,5 PR17Y CLASSIC PR17YC SUPER
SL 2, SL 3, SL 3S 0,5 P17 CLASSIC
SL-21 P15 CLASSIC
SL 31, SL 35 0,5 P17 CLASSIC

JOHN DEERE

ELEKTROCENTRÁLY / STACIONÁRNÍ MOTORY • ELEKTROCENTRALS / STATIONARY ENGINES • ЭЛЕКТРИЧЕСКИЕ КОММУТАТОРЫ / СТАЦИОНАРНЫЕ ДВИГАТЕЛИ

225 PR17 CLASSIC
325 PR17 CLASSIC
375 PR17 CLASSIC
500 PR17 CLASSIC
650 PR17 CLASSIC
1750W 0,6 J17 CLASSIC
3000W 0,6 J17 CLASSIC
4000W 0,6 J17 CLASSIC
5000W NR15C SUPER NR15S SILVER

KŘOVINOŘEZY • BRUSH CUTTERS • ТРИММЕРЫ

90G, 110G, 210G, 240G, 260G P17Y CLASSIC PR17YC SUPER
1032 0,5 K19 CLASSIC

KULTIVÁTORY • CULTIVATORS • КУЛЬТИВАТОРЫ

216 0,5 K19 CLASSIC
624 0,5 JR17 CLASSIC

MALOTRAKTORY • TRACTORS • МАЛОГАБАРИТНЫЕ ТРАКТОРЫ

108, 111, 111H, 116, 116H 0,5 P17 CLASSIC
110 K17C SUPER
112, 140 0,6 N19C SUPER
130, 180, 185 0,6 LR17YC SUPER LR17YS SILVER
316, 318, 420 0,6 GR17YC SUPER GR17YS SILVER
AMT 600 N17C SUPER
F 910, F 930 0,6 GR17YC SUPER GR17YS SILVER

MOTOROVÉ PÍLY • CHAINSAW • МОТОПИЛЫ

8, 9, 12, 14, 15, 17, 18, 19 P15 CLASSIC
23, 28, 30, 40V, 50 P17 CLASSIC
50V, 61, 81, 91 P15 CLASSIC
25EV, 35EV, 46EV, 51SV, 55EV P17Y CLASSIC PR17YC SUPER
65EV, 65SV, 66SV, 70V, 72, 80EV P17Y CLASSIC PR17YC SUPER



service instructions

... BOSCH ...
... CHAMPION ...
... NGK ...



BRISK

LAST INFO

**STANDARD
BRISK**
**ALTERNATIVE
BRISK**
JOHN DEERE
MOTOROVÉ PÍLY • CHAINSAW • МОТОПИЛЫ

450V, 800V		P17Y	CLASSIC	PR17YC	SUPER
R 70EV		P17Y	CLASSIC	PR17YC	SUPER
S 80		P17Y	CLASSIC	PR17YC	SUPER

MOTOROVÉ TRAVNÍ SEKAČKY • LAWN MOWER • СЕНОКОСИЛКИ

12PB, 12SB, 14PZ, 14SZ		J19	CLASSIC		
14SB, 14SE, 14PB		L15YC	SUPER	LR15YS	SILVER
48, 52		LR17YC	SUPER	LR17YS	SILVER
56, 57, 65, 66, 68	0,8	K19	CLASSIC		
F 510, F 525, F 710, FC 420		LR17YC	SUPER	LR17YS	SILVER
F 725		J19	CLASSIC		
F 910, F 930		GR17YC	SUPER	GR17YS	SILVER
F 912, F 932 (Yanmar 20-28 HP)		LR17YC	SUPER	LR17YS	SILVER
FC 150V		L15YC	SUPER	LR15YS	SILVER
FC 540CV (all models)		LR17YC	SUPER	LR17YS	SILVER
R 70, R 72	0,8	K19	CLASSIC		
S 28, S 80, S 82, S 90, S 92	0,8	K19	CLASSIC		
Tecumseh - all models		PR17Y	CLASSIC	PR17YC	SUPER

JONSERED
ELEKTROCENTRÁLY / STACIONÁRNÍ MOTORY • ELEKTROCENTRALS / STATIONARY ENGINES • ЭЛЕКТРИЧЕСКИЕ КОММУТАТОРЫ / СТАЦИОНАРНЫЕ ДВИГАТЕЛИ

WP 25		PR18Y	CLASSIC		
-------	--	-------	---------	--	--

KŘOVINOŘEZY • BRUSH CUTTERS • ТРИММЕРЫ

BV 32	0,5	PR18Y	CLASSIC		
GR 32, GR 36, GR 41, GR 44, GR 50	0,5	PR17Y	CLASSIC	PR17YC	SUPER
GR 2026D, GR 2032D	0,5	PR17Y	CLASSIC	PR17YC	SUPER
GR 2036D	0,5	PR17Y	CLASSIC	PR17YC	SUPER
HT 21	0,5	PR18Y	CLASSIC		
RS 38	0,5	N17C	SUPER		
RS 40, RS 44, RS 45, RS 51, RS 52	0,5	PR17Y	CLASSIC	PR17YC	SUPER

MALOTRAKTORY • TRACTORS • МАЛОГАБАРИТНЫЕ ТРАКТОРЫ

FR 13		JR19	CLASSIC		
JH 125 (5,5 HP), JH 129 (9 HP)		LR15YC	SUPER	LR15YS	SILVER
LR 8, LR 10, LR 12, LR 12,5, LR 13 (B&S)		JR19	CLASSIC		
LT 12, LT 14		JR19	CLASSIC		
LTH 12		JR19	CLASSIC		
YTH 16 (OHV B&S)		DR17YC	SUPER	DR17YS	SILVER

MOTOROVÉ PÍLY • CHAINSAW • МОТОПИЛЫ

45, 49SP, 50, 51, 52, 52E	0,5	PR17Y	CLASSIC	PR17YC	SUPER
66E, 66ES, 70E, 80, 90, 90W, 111	0,5	PR17Y	CLASSIC	PR17YC	SUPER
361, 365, 370, 380, 410, 420, 435	0,5	PR17Y	CLASSIC	PR17YC	SUPER
450, 455, 490, 451, 452, 451EV, 510SP	0,5	PR17Y	CLASSIC	PR17YC	SUPER
520, 521EV, 525, 590, 621, 630, 630S	0,5	PR17Y	CLASSIC	PR17YC	SUPER
801	0,5	PR17Y	CLASSIC	PR17YC	SUPER
810, 820, 830, 840, 910, 920, 930, 1020	0,5	PR15Y	CLASSIC	PR17YC	SUPER
2040, 2044, 2051, 2077	0,5	PR17Y	CLASSIC	PR17YC	SUPER
6000+	0,5	PR15Y	CLASSIC	PR17YC	SUPER
J 535, J 625, J 670	0,5	PR17Y	CLASSIC	PR17YC	SUPER
J 2036 Turbo, J 2041 Turbo	0,5	PR17Y	CLASSIC	PR17YC	SUPER
J 2045 Turbo, J 2050 Turbo	0,5	PR17Y	CLASSIC	PR17YC	SUPER
J 2054 Turbo, J 2055 Turbo	0,5	PR17Y	CLASSIC	PR17YC	SUPER
J 2063 Turbo, J 2065 Turbo	0,5	PR17Y	CLASSIC	PR17YC	SUPER
J 2071 Turbo	0,5	PR17Y	CLASSIC	PR17YC	SUPER
J 2083 Turbo, J 2095 Turbo	0,5	PR15Y	CLASSIC	PR17YC	SUPER
L1LJ	0,5	P15	CLASSIC		
M 36, M 361, M 361AV, M 365	0,5	P15	CLASSIC		
M 50, M 52, M 60, M 62, M 75, M 80, M 110	0,5	P17Y	CLASSIC	PR17YC	SUPER
M 601, M 621, M 751	0,5	P17Y	CLASSIC	PR17YC	SUPER



STANDARD
BRISK

ALTERNATIVE
BRISK

JONSERED

MOTOROVÉ PILY • CHAINSAW • МОТОПИЛЫ

MK 70, MK 80	0,5	P17Y	CLASSIC	PR17YC	SUPER
RS 45	0,5	P17Y	CLASSIC	PR17YC	SUPER

MOTOROVÉ TRAVNÍ SEKAČKY • LAWN MOWER • СЕНОКОСИЛКИ

46RD, 46RDE, 346, 350S, 446R, 450M	JR19	CLASSIC			
450R, 455SD, 455RD, 555RD, 555RDE	JR19	CLASSIC			
JS 241 (B&S)	JR19	CLASSIC			

KAAZ

MOTOROVÉ PILY • CHAINSAW • МОТОПИЛЫ

G 2, G 2C (Zenoah)	P15	CLASSIC			
G 3C, G 4C, G 5C (Zenoah)	N17C	SUPER			
KT 12, KT 18 (Kawasaki)	P17	CLASSIC			
KT 15, KT 17 (Kawasaki)	P15	CLASSIC			
T 50 (Mitsubishi)	P17	CLASSIC			

KATEX

MOTOROVÉ PILY • CHAINSAW • МОТОПИЛЫ

38 Super, 255	P17	CLASSIC			
KAT 10, KAT 25DAEX	P17	CLASSIC			
KAT 34	PR18Y	CLASSIC			
Woody 56	PR18Y	CLASSIC			

KAWASAKI

ELEKTROCENTRÁLY / STACIONÁRNÍ MOTORY • ELEKTROCENTRALS / STATIONARY ENGINES • ЭЛЕКТРИЧЕСКИЕ КОММУТАТОРЫ / СТАЦИОНАРНЫЕ ДВИГАТЕЛИ

FJ 180V	LR17YC	SUPER	LR17YS	SILVER	
FH 430V, FH 451V, FH 500V, FH 531V, FH 541V, FH 580V	PR18Y	CLASSIC			
FH 601V, FH 641V, FH 661V, FH 680V, FH 721V	6	A-line	LR17YS	SILVER	
GA 550A, GA 1000A, GA 1400A	PR17	CLASSIC			
GA 1800A	NR17YC	SUPER			
GA 2300 (-83)	K17C	SUPER			
GA 2300A, GA 3200A, GA 3200AS	NR17YC	SUPER			
GA 2300A	NR17YC	SUPER			
GB 2300A	NR17YC	SUPER			
GC 550A	PR17	CLASSIC			
GD 550A, GD 700A, GD 700AS	PR17	CLASSIC			
GE 2200A, GE 2900A, GE 4300	LR17YC	SUPER	LR17YS	SILVER	
GE 2900, GE 4000	LR17YC	SUPER	LR17YS	SILVER	
GE 4300A, GE 4500, GE 4500A	LR17YC	SUPER	LR17YS	SILVER	
GE 5000, GE 5000AS	LR17YC	SUPER	LR17YS	SILVER	
KG 500	P17	CLASSIC			
KG 550, KG 600, KG 700, KG 750	N15C	SUPER	NR15S	SILVER	
KG 550B	NR15C	SUPER	NR15S	SILVER	
KG 750B, KG 900, KG 1000, KG 1100B	K17C	SUPER			
KG 1300, KG 1500	N15C	SUPER	NR15S	SILVER	
KG 1600, KG 4000AS	NR15C	SUPER	NR15S	SILVER	
KG 1600B	NR15C	SUPER	NR15S	SILVER	
KG 2300, KG 2600	NR17YC	SUPER			
KG 2300 (-83), KG 2600 (-83)	K17C	SUPER			
KG 2900, KG 4000A	NR15C	SUPER	NR15S	SILVER	
KG 5000 (-83)	P17	CLASSIC			
KG 5000A, KG 5000AS	N19C	SUPER			
KG 5000B, KG 5000BS	N19C	SUPER			

MALOTRAKTORY • TRACTORS • МАЛОГАБАРИТНЫЕ ТРАКТОРЫ

KG 2300, KG 2600 / (08.80-08.83)	K17C	SUPER			
KG 2300, KG 2600 / (09.83-)	N17YC	SUPER			
KG 5000 (08.80-08.83)	P17	CLASSIC			

KNIGHT

MOTOROVÉ PILY • CHAINSAW • МОТОПИЛЫ

14mm Ø	K19	CLASSIC			
--------	-----	---------	--	--	--



service instructions

... BOSCH ...
... CHAMPION ...
... NGK ...



BRISK

LAST INFO



STANDARD
BRISK

ALTERNATIVE
BRISK

KOHLER

ELEKTROCENTRÁLY / STACIONÁRNÍ MOTORY • ELEKTROCENTRALS / STATIONARY ENGINES • ЭЛЕКТРИЧЕСКИЕ КОММУТАТОРЫ / СТАЦИОНАРНЫЕ ДВИГАТЕЛИ

1.75 MBFM		PR17	CLASSIC		
1.75 MBM25, 1.75 MFM, 1.75 MM25		K17C	SUPER		
2.25 MBFM25, 2.25 MBFM45, 2.25 MBM25		PR17	CLASSIC		
3 MM25, 3 MMV55		K17C	SUPER		
3.5 MBFM45, 3.5 MBFM65		PR17	CLASSIC		
3.5 MBM25, 3.5 MBM65		PR17	CLASSIC		
3.5 MFM45, 3.5 MFM65		K17C	SUPER		
3.5 MM25, 3.5 MM65		K17C	SUPER		
4 A-23		K17C	SUPER		
5 MBM25, 5 MBM65		PR17	CLASSIC		
5 MFM45		K17C	SUPER		
7.5 A-23		K17C	SUPER		
7.5 R-81		L15C ^{+R}	SUPER		
25 R-81 - 34 HP - Gasoline		K17C	SUPER		
B & S - 14mm head		K19	CLASSIC		
B & S - 14mm head (800 Watt)	0,5	JR19	CLASSIC		
B & S - 18mm		L15C ^{+R}	SUPER		
B & S - 18mm head (800 Watt)		FR17YC	SUPER		
CV 11, CV 12,5, CV 14, CV 15, CV 16		DR17YC	SUPER	DR17YS	SILVER
CV 460-493		DR17YC	SUPER	DR17YS	SILVER
Command		DR17YC	SUPER	DR17YS	SILVER
Courage		DR17YC	SUPER	DR17YS	SILVER
Daihatsu FE		L17YC	SUPER	LR17YS	SILVER
FC - 18mm head - 6,8 HP / 13,6 HP		L15C ^{+R}	SUPER		
Ford 8C / 10C / 12,5C - Marine (1,1 Ltr.)	0,6	GR17YC	SUPER	GR17YS	SILVER
Gasoline - 68 HP, 136 HP		L15C ^{+R}	SUPER		
Honda - 13 HP - L/C 3.5 CFZ, 5CFZ - Marine		NR15YC	SUPER		
Honda - 13 HP - L/C 4CZ, 6.5CZ - Marine		NR15YC	SUPER		
K 12 - 4 HP		K17C	SUPER		
K 7 - 2,7 HP (350 Watt)		K17C	SUPER		
K 90 - 4 HP, K 91 - 4 HP (500 Watt)		K17C	SUPER		
K 160 - 3,4 HP, K 161 - 3,4 HP		K17C	SUPER		
K 160 - 7 HP, K 161 - 7 HP (2.5 MV55)		K17C	SUPER		
K 181 - 8 HP		K17C	SUPER		
K 330, K 331 / 2HP / 4,8 HP / 15,5 HP		K17C	SUPER		
K 662		K17C	SUPER		
KT 17 - 17 HP	0,6	HR17YC	SUPER		
KT 19 - 19 HP	0,6	HR17YC	SUPER		
KT 21 - 21 HP	0,6	HR17YC	SUPER		
L 160 - 7 HP, L 161 - 7 HP		K17C	SUPER		
L 160 - 6,8 HP, L 161		K17C	SUPER		
L 600 - 2,7 HP / 4,8 HP / 6,8 HP		K17C	SUPER		
L 654		K17C	SUPER		
MM25 - 2 HP / 4,1 HP		K17C	SUPER		
Propane - 25R81 - 34 HP		K17C	SUPER		
Propane - 68 HP, 136 HP		L15C ^{+R}	SUPER		
S, D - 18mm head - 1,4 HP		L15C ^{+R}	SUPER		
SV 470, SV 480, SV 530, SV 540, SV 590, SV 600		DR17YC	SUPER	DR17YS	SILVER
Waukesha 180GLB - 136, HP		L15C ^{+R}	SUPER		
Waukesha 185GLB - 20,5 HP		L15C ^{+R}	SUPER		
Waukesha 195GL - 47,5 HP		L15C ^{+R}	SUPER		
Wisconsin VH4D		L15C ^{+R}	SUPER		

KOMATSU ZENOAH

KŘOVINOŘEZY • BRUSH CUTTERS • ТРИММЕРЫ

AG 230, AG 431, AG 530	0,5	PR18Y	CLASSIC		
BC 342DLM, BC 342DWM	0,5	PR18Y	CLASSIC		



KOMATSU ZENOAH

KŘOVINOŘEZY • BRUSH CUTTERS • ТРИММЕРЫ

BC 435DLM, BC 435DWM, BC 534DWM	0,5	PR18Y	CLASSIC		
BC 2200DL	0,5	PR18Y	CLASSIC		
BC 2302DLM,	0,5	PR18Y	CLASSIC		
BC 2601DLM, BC 2601DWM	0,5	PR17Y	CLASSIC	PR17YC	SUPER
BK 436FL, BK 531DL	0,5	PR18Y	CLASSIC		
CHT 2300B, CHT 2300D	0,5	PR18Y	CLASSIC		
HT 2300A	0,5	PR18Y	CLASSIC		
LRT 2300	0,5	PR18Y	CLASSIC		
SGC 2300DL	0,5	PR18Y	CLASSIC		

MOTOROVÉ PÍLY • CHAINSAW • МОТОПИЛЫ

G 300AV, G 300AVS, G 300T		PR18Y	CLASSIC		
G 300TS, G 310TS		PR18Y	CLASSIC		
G 320AV, G 320AVS		PR18Y	CLASSIC		
G 380AV, G 380AVS		PR18Y	CLASSIC		
G 400AVS, G 415AVS, G 455AVS		PR17Y	CLASSIC	PR17YC	SUPER
G 500AVS, G 560AV, G 560AVS		PR17Y	CLASSIC	PR17YC	SUPER
G 561AVS, G 561AVSH, G 620AV		PR17Y	CLASSIC	PR17YC	SUPER
G 620AVS, G 621AVS, G 621AVSH		PR17Y	CLASSIC	PR17YC	SUPER

KUBOTA

ELEKTROCENTRÁLY / STACIONÁRNÍ MOTORY • ELEKTROCENTRALS / STATIONARY ENGINES • ЭЛЕКТРИЧЕСКИЕ КОММУТАТОРЫ / СТАЦИОНАРНЫЕ ДВИГАТЕЛИ

A 400 (GN550)		PR17	CLASSIC		
A 800 (GN130)	0,6	NR17YC	SUPER		
A 1200 (GS130)	0,6	NR17YC	SUPER		
A 1800 (GN1850)		NR17YC	SUPER		
A 2500 (GN2500)		NR17YC	SUPER		
A 3050 (GS280)	0,6	NR17YC	SUPER		

LANCASTER

MOTOROVÉ PÍLY • CHAINSAW • МОТОПИЛЫ

50, 50HL, 50IL, 60HL	0,9	P17	CLASSIC		
200A, 352, 350A, 350B, 400B		K19	CLASSIC		
350, 400S, 425, 440, 447, 450		K19	CLASSIC		
547, 540, 550, 645, 655, 670		K19	CLASSIC		
555, 560		P17	CLASSIC		
558, 650, 658		K17C	SUPER		
600HL, 700HL	0,9	P17	CLASSIC		
Mini Twelve, Mini Auto		P17	CLASSIC		
Six-10, Eight-20		N15C	SUPER	NR15S	SILVER
SLA, SLA 20		P17	CLASSIC		

LANDONI

MALOTRAKTORY • TRACTORS • МАЛОГАБАРИТНЫЕ ТРАКТОРЫ

FA 30	0,5	P17Y	CLASSIC	PR17YC	SUPER
-------	-----	------	---------	--------	-------

MOTOROVÉ PÍLY • CHAINSAW • МОТОПИЛЫ

L 40		P17	CLASSIC		
L 48, L 48E		P17Y	CLASSIC	PR17YC	SUPER
L 90	0,6	N14C	SUPER	NR14S	SILVER
L 98, L 110	0,6	N15C	SUPER	NR15S	SILVER
L 75, L 773		U17	CLASSIC		
L 722L, L 722S, L 771E, L 771S		P17Y	CLASSIC	PR17YC	SUPER
LF 30CL, LF 36 Super		P17Y	CLASSIC	PR17YC	SUPER

LASER

MALOTRAKTORY • TRACTORS • МАЛОГАБАРИТНЫЕ ТРАКТОРЫ

L 80		JR19	CLASSIC		
L 95, L 110		DR17YC	SUPER	DR17YS	SILVER

LAWN-BOY

KŘOVINOŘEZY • BRUSH CUTTERS • ТРИММЕРЫ

All models	0,5	U17	CLASSIC		
------------	-----	-----	---------	--	--



service
instructions

... BOSCH ...
... CHAMPION ...
... NGK ...



LAST INFO



**STANDARD
BRISK**

**ALTERNATIVE
BRISK**

LICKETY CHIPPER

MOTOROVÉ PÍLY • CHAINSAW • МОТОПИЛЫ

KPM 4	K19	CLASSIC		
-------	-----	---------	--	--

LINDIG

MOTOROVÉ PÍLY • CHAINSAW • МОТОПИЛЫ

900 - V465D, XR965	L17YC	SUPER	LR17YS	SILVER
Apache	K19	CLASSIC		
B & S - Concho, Kajon, KM-10	J19	CLASSIC		
M-4, M-8, M-10, M-12	K19	CLASSIC		

LOMBARD

MOTOROVÉ PÍLY • CHAINSAW • МОТОПИЛЫ

3, 3A, 3.5, 5, 5A, 30, 34	P17	CLASSIC		
4, 7	K19	CLASSIC		
35, 36, 37, 68, 69, 70	P17	CLASSIC		
648, 650, 658	K19	CLASSIC		
660	P17	CLASSIC		
AL 42, AL 42 Auto., AL 42 Super, AL 51, AL 51 Auto.	P15	CLASSIC		
AP 22, AP 22-1, AP 22D, AP 22D-1, AP 24, AP 24D	P17Y	CLASSIC	PR17YC	SUPER
AP 42, AP 42-1, AP 42D, AP 42SE / (AV)	P17Y	CLASSIC	PR17YC	SUPER
F 54	P17	CLASSIC		
L 30, L 50, L 55, L 70, L 80, L 90, L 100	P17	CLASSIC		
Little Lightning Comango	P17Y	CLASSIC	PR17YC	SUPER
Little Lightning Deluxe	P17Y	CLASSIC	PR17YC	SUPER
Little Lightning Super Deluxe	P17Y	CLASSIC	PR17YC	SUPER
Pony	U17	CLASSIC		
Super - Comango	P15	CLASSIC		
Super - Comango - Super Comango Auto.	P15	CLASSIC		
Super - L 100	K15YC	SUPER		
Super - L 30, L 50, L 60, L 70, L 90	P17	CLASSIC		
Super - Lightning, AV	P17Y	CLASSIC	PR17YC	SUPER

LZDP

ELEKTROCENTRÁLY / STACIONÁRNÍ MOTORY • ELEKTROCENTRALS / STATIONARY ENGINES • ЭЛЕКТРИЧЕСКИЕ КОММУТАТОРЫ / СТАЦИОНАРНЫЕ ДВИГАТЕЛИ

P - 10DU, P - 350, P - 350-1	0,6	N17C	SUPER	
------------------------------	-----	------	-------	--

MAKITA

ELEKTROCENTRÁLY / STACIONÁRNÍ MOTORY • ELEKTROCENTRALS / STATIONARY ENGINES • ЭЛЕКТРИЧЕСКИЕ КОММУТАТОРЫ / СТАЦИОНАРНЫЕ ДВИГАТЕЛИ

G 1200R EY15D Robin 134cc		NR15C	SUPER	NR15S	SILVER
G 1200R EY15D Robin 143cc		NR15C	SUPER	NR15S	SILVER
G 2400R EY20D Robin 183cc		NR15C	SUPER	NR15S	SILVER
G 2410R EH17D Robin 172cc	0,6	N15C	SUPER	NR15S	SILVER
G 2800R		NR15C	SUPER	NR15S	SILVER
G 3500R EY28D Robin 273cc	0,6	NR15YC	SUPER		
G 3501R EY28D Robin 273cc	0,6	NR15YC	SUPER		
G 3510R EH25D Robin 251cc	0,6	N15C	SUPER	NR15S	SILVER
G 3511R EH25D Robin 251cc	0,6	N15C	SUPER	NR15S	SILVER
G 5500R EY40D Robin 388cc	0,6	NR17YC	SUPER		
G 5501R EY40D Robin 388cc	0,6	NR17YC	SUPER		
G 5710R EH34D Robin 388cc	0,6	LR15C	SUPER	LR15S	SILVER
G 5711R EH34D Robin 388cc	0,6	LR15C	SUPER	LR15S	SILVER

MANO MFG.CO.

MOTOROVÉ PÍLY • CHAINSAW • МОТОПИЛЫ

Chrysler - 611010, 86010	N15C	SUPER	NR15S	SILVER
--------------------------	------	-------	-------	--------

MASSEY-FERGUSON

MALOTRAKTORY • TRACTORS • МАЛОГАБАРИТНЫЕ ТРАКТОРЫ

C 20	N17C	SUPER		
K 20	N17C	SUPER		
M 35	N17C	SUPER		
MF 35	N17C	SUPER		
P 20	N17C	SUPER		



MASSEY-FERGUSON

MALOTRAKTORY • TRACTORS • МАЛОГАБАРИТНЫЕ ТРАКТОРЫ

TEA 20	N17C	SUPER	
--------	------	-------	--

MOTOROVÉ PÍLY • CHAINSAW • МОТОПИЛЫ

190A	U15	CLASSIC	
250	U15	CLASSIC	
370, 370A, 370AR	P17	CLASSIC	

MATRIX

ELEKTROCENTRÁLY / STACIONÁRNÍ MOTORY • ELEKTROCENTRALS / STATIONARY ENGINES • ЭЛЕКТРИЧЕСКИЕ КОММУТАТОРЫ / СТАЦИОНАРНЫЕ ДВИГАТЕЛИ

PG 800	LR17YC	SUPER	LR17YS	SILVER
--------	--------	-------	--------	--------

McCULLOCH

ELEKTROCENTRÁLY / STACIONÁRNÍ MOTORY • ELEKTROCENTRALS / STATIONARY ENGINES • ЭЛЕКТРИЧЕСКИЕ КОММУТАТОРЫ / СТАЦИОНАРНЫЕ ДВИГАТЕЛИ

150, 200, 300, 400	K19	CLASSIC	
All Other Models	P17	CLASSIC	
Aqua Mac	0,8 U17	CLASSIC	
H-1500, H-2000, H-3000	K17C	SUPER	
HP-1200, HP-2000, HP-3000	K17C	SUPER	
HP-3500, HP-3500 Deluxe	K17C	SUPER	
HP-5000, HP-5000 Deluxe	K17C	SUPER	
Mark I, Mark II, Mark III	K17C	SUPER	
MC 2106, MC 2108, MC 2109, MC 2110	0,8 U17	CLASSIC	
MPP 1500E, MPP 2300E, MPP 3500E	0,5 N19C	SUPER	
MPP 600E, MPP 800E	0,5 N19C	SUPER	
RA 120, RA 150, RA 200	PR17	CLASSIC	
RA 330, RA 400ES	PR17	CLASSIC	

KŘOVINOŘEZY • BRUSH CUTTERS • ТРИММЕРЫ

Blower Vac, Blower Vac 30	UR17	CLASSIC	
BP 26AV, BP 30AV, BP 38AV	UR17	CLASSIC	
BP 3000, BP 4000	UR17	CLASSIC	
Elite 3900 Pro	UR17	CLASSIC	
Elite 4000, Elite 4100, Elite 4600, Elite 470	UR17	CLASSIC	
H 45 Euromac, H 60 Euromac	UR17	CLASSIC	
HC 7	UR17	CLASSIC	
HC 45, HC 60	UR17	CLASSIC	
Mac 17, Mac 21	UR17	CLASSIC	
Mac 25, Mac 26, Mac 30, Mac 30AV, Mac 38AV	UR17	CLASSIC	
Mac 22, Mac 23	P15	CLASSIC	
Mac 32, Mac 37	0,5 N17C	SUPER	
Mac 52	0,5 K17C	SUPER	
Mac 60SX, Mac 65, Mac 80A, Mac 80SX	UR17	CLASSIC	
Mac 90, Mac 95	UR17	CLASSIC	
MP 390	UR17	CLASSIC	
MT 270, MT 280, MT 290, MT 302, MT 320	UR17	CLASSIC	
Panama 41, Panama 53	UR17	CLASSIC	
PM 2000, PM 2100, PM 2500, PM 3000	UR17	CLASSIC	
PM 3100, PM 3500, PM 3600, PM 4000	UR17	CLASSIC	
PM 4100, PM 4150, PM 5300	UR17	CLASSIC	
Pro Mac 38AV	UR17	CLASSIC	
SH 45 Euromac	UR17	CLASSIC	
SL 60 Roadrunner, SL 80 Roadrunner	UR17	CLASSIC	
Super Mac 28, Super Mac 30AV	UR17	CLASSIC	
Super Mac 38AV	UR17	CLASSIC	
TH 60, TH 700	UR17	CLASSIC	
Tivoli 45, Tivoli 60	UR17	CLASSIC	

MOTOROVÉ PÍLY • CHAINSAW • МОТОПИЛЫ

1-40, 1-50, 1-60, 1-70, 1-71, 1-72	K19	CLASSIC	
1-9	P17Y	CLASSIC	PR17YC SUPER
2-3	P17Y	CLASSIC	PR17YC SUPER



service instructions

... BOSCH ...
... CHAMPION ...
... NGK ...



LAST INFO



STANDARD
BRISK

ALTERNATIVE
BRISK

McCULLOCH

MOTOROVÉ PILY • CHAINSAW • МОТОПИЛЫ

3-10, 3-10E	UR17	CLASSIC		
5-10A, 5-10G, 6-10	U15	CLASSIC		
6-10, 6-10A	U15	CLASSIC		
7-10A	U15	CLASSIC		
10-10, 10-10A, 10-10L	UR17	CLASSIC		
250, 550	K19	CLASSIC		
640, 650, 660	K19	CLASSIC		
795, 795L, 895	UR17	CLASSIC		
California, California 90, California 2000	UR17	CLASSIC		
CP 55, CP 125, CP 125S	UR17	CLASSIC		
CP 70, CP 70L	U15	CLASSIC		
Daytona 1000	UR17	CLASSIC		
Daytona 3000	PR17Y	CLASSIC	PR17YC	SUPER
DE 50, DE 80	UR17	CLASSIC		
Eagle 50	UR17	CLASSIC		
G 70	U15	CLASSIC		
LG 6	U15	CLASSIC		
Mac 110, Mac 120, Mac 130, Mac 140	UR17	CLASSIC		
Mac 160S	UR17	CLASSIC		
Mac 835, Mac 836, Mac 838, Mac 839	UR17	CLASSIC		
Mac 935, Mac 940, Mac 955	UR17	CLASSIC		
Mac 950, Mac 960, Mac 970	PR17Y	CLASSIC	PR17YC	SUPER
Mini-Mac, Mini-Mac 6, Mini-Mac 6A	UR17	CLASSIC		
Mini-Mac 25, Mini-Mac 30, Mini-Mac 35	UR17	CLASSIC		
Mini Pro 25, Mini Pro 30, Mini Pro 35	UR17	CLASSIC		
Mustang	UR17	CLASSIC		
P 10, P 10A	UR17	CLASSIC		
PM 6, PM 6A, PM 10/10, PM 55	UR17	CLASSIC		
PM 105, PM 120	UR17	CLASSIC		
PM 130, PM 140, PM 310, PM 320, PM 330	UR17	CLASSIC		
PM 340, PM 360, PM 374, PM 394	UR17	CLASSIC		
PM 470, PM 474, PM 480, PM 484	UR17	CLASSIC		
PM 486, PM 494, PM 555, PM 570	UR17	CLASSIC		
PM 610/40, PM 610/50	UR17	CLASSIC		
PM 650/40, PM 650/50	UR17	CLASSIC		
PM 730, PM 735, PM 740	UR17	CLASSIC		
PM 800, PM 850	UR17	CLASSIC		
PM 3500, PM 4000, PM 5000	UR17	CLASSIC		
Power Mac 310, Power Mac 320	UR17	CLASSIC		
Power Mac 330, Power Mac 340	UR17	CLASSIC		
Power Mac 380, Power Mac 390	UR17	CLASSIC		
Pro Mac 10-10S, Pro Mac 36, Pro Mac 38	UR17	CLASSIC		
Pro Mac 40, Pro Mac 46, Pro Mac 51	UR17	CLASSIC		
Pro Mac 55, Pro Mac 60	UR17	CLASSIC		
Pro Mac 510, Pro Mac 555, Pro Mac 570	UR17	CLASSIC		
Pro Mac 610, Pro Mac 645, Pro Mac 650	UR17	CLASSIC		
Pro Mac 655, Pro Mac 690	UR17	CLASSIC		
Pro Mac 605, Pro Mac 850	UR15	CLASSIC		
Pro Mac 700, Pro Mac 800	UR17	CLASSIC		
Pro Mac 1000, Pro Mac 1010	UR17	CLASSIC		
Pro Mac 8200	UR15	CLASSIC		
S 6-10A	U15	CLASSIC		
S 2-10A	UR17	CLASSIC		
S 10-10, S10-10E, S 10-10LA, S10-10L	UR17	CLASSIC		
S 250, S 550	K19	CLASSIC		
S 797	UR17	CLASSIC		



STANDARD
BRISK

ALTERNATIVE
BRISK

McCULLOCH

MOTOROVÉ PILY • CHAINSAW • МОТОПИЛЫ

SLG 2		UR17	CLASSIC		
SP 40		UR15	CLASSIC		
SP 60		UR17	CLASSIC		
SP 70, SP 80, SP 81, SP 105, SP 125C		UR15	CLASSIC		
Timber Bear		UR17	CLASSIC		
Titan 7, Titan 35, Titan 57, Titan 70		UR17	CLASSIC		
Titan 40,50		UR15	CLASSIC		
Wildcat 18		UR17	CLASSIC		

MITSUBISHI

ELEKTROCENTRÁLY / STACIONÁRNÍ MOTORY • ELEKTROCENTRALS / STATIONARY ENGINES • ЭЛЕКТРИЧЕСКИЕ КОММУТАТОРЫ / СТАЦИОНАРНЫЕ ДВИГАТЕЛИ

G 221, G 271, G 351, G 400PV, G 511	0,8	P17	CLASSIC		
G 711, G 911, G 1050, G 1200, G 1500	0,8	P17	CLASSIC		
GM 90, GM 130, GM 150V		L17YC	SUPER	LR17YS	SILVER
GM 180, GM 290, GM 300		L17YC	SUPER	LR17YS	SILVER
MG 650-D, MG 1300-D		P15	CLASSIC		
MG 2000-D, MG 3000-D		P15	CLASSIC		
T 50, T 80, T 110, T 130, T 140, T 170	0,8	P17	CLASSIC		
T 200, T 240, T 280, T 340, T 350, T 430	0,8	P17	CLASSIC		
T 400PV	0,8	P17Y	CLASSIC	PR17YC	SUPER
TL 26, TL 33, TL 43, TL 52		PR17	CLASSIC		
TM 18, TM 21, TM 24, TM 33	0,8	P17	CLASSIC		

MALOTRAKTORY • TRACTORS • МАЛОГАБАРИТНЫЕ ТРАКТОРЫ

All models		L17YC	SUPER	LR17YS	SILVER
------------	--	-------	-------	--------	--------

MOSA

MALOTRAKTORY • TRACTORS • МАЛОГАБАРИТНЫЕ ТРАКТОРЫ

GE 3500, GE 5000B, GE 5001B	0,5	N19C	SUPER		
MS 170, MS 170S, MS 170 Electronic		N14YC	SUPER		
MSG 170, MSG 200S, MSG Electronic		N14YC	SUPER		
TS 180B, TS 180BE		N19C	SUPER		

MOTOR JIKOV

KULTIVÁTORY • CULTIVATORS • КУЛЬТИВАТОРЫ

1433	0,6	N17C	SUPER		
1438	0,6	D17YC	SUPER	DR17YS	SILVER
1440	0,6	D17YC	SUPER	DR17YS	SILVER
1447, 1447 DV, 1447 LTS	0,6	D17YC	SUPER	DR17YS	SILVER
1453, 1453 DV, 1453 LTS	0,6	D17YC	SUPER	DR17YS	SILVER
1454, 1454 DV	0,6	D17YC	SUPER	DR17YS	SILVER

MOTOROVÉ TRAVNÍ SEKAČKY • LAWN MOWER • СЕНОКОСИЛКИ

1433	0,6	N17C	SUPER		
1438	0,6	D17YC	SUPER	DR17YS	SILVER
1440	0,6	D17YC	SUPER	DR17YS	SILVER
1447, 1447 DV, 1447 LTS	0,6	D17YC	SUPER	DR17YS	SILVER
1453, 1453 DV, 1453 LTS	0,6	D17YC	SUPER	DR17YS	SILVER
1454, 1454 DV	0,6	D17YC	SUPER	DR17YS	SILVER

MOUNTFIELD

ELEKTROCENTRÁLY / STACIONÁRNÍ MOTORY • ELEKTROCENTRALS / STATIONARY ENGINES • ЭЛЕКТРИЧЕСКИЕ КОММУТАТОРЫ / СТАЦИОНАРНЫЕ ДВИГАТЕЛИ

AG 2 (B & S - 5 HP)		JR19	CLASSIC		
ESE 20 (B & S - 4 HP)		JR19	CLASSIC		
FS 45TL (B & S)		DR17YC	SUPER	DR17YS	SILVER
SA 18, SA 30TL		PR17Y	CLASSIC	PR17YC	SUPER
TAG 3 (B&S - 4 HP), TAG 6 (B&S - 11 HP)		JR19	CLASSIC		

KŘOVINOŘEZY • BRUSH CUTTERS • ТРИММЕРЫ

AM 180	0,5	PR17Y	CLASSIC	PR17YC	SUPER
MTL 50	0,5	PR17Y	CLASSIC	PR17YC	SUPER
XB 27D		TR14C	SUPER	TR14S	SILVER
XR 27		TR14C	SUPER	TR14S	SILVER



service
instructions

... BOSCH ...
... CHAMPION ...
... NGK ...



BRISK

LAST INFO



**STANDARD
BRISK**

**ALTERNATIVE
BRISK**

MOUNTFIELD

KULTIVÁTOŘY • CULTIVATORS • КУЛЬТИВАТОРЫ

Manor - 3 HP, Manor - 5 HP	JR19	CLASSIC		
MS 06, MS 16, MS 19	JR19	CLASSIC		

MALOTRAKTORY • TRACTORS • МАЛОГАБАРИТНЫЕ ТРАКТОРЫ

11-32RER (B & S - 11,5 HP)	JR19	CLASSIC		
14-38HXL (B & S - 14,5 HP)	DR17YC	SUPER	DR17YS	SILVER
270HE (KOHLER OHV)	DR17YC	SUPER	DR17YS	SILVER
622 / 824 (Tecumseh)	JR19	CLASSIC		
CCR 2500 (Tecumseh)	PR18Y	CLASSIC		
CCR Powerlite (Tecumseh)	PR18Y	CLASSIC		
L 1000 (B & S - 11,5 HP)	JR19	CLASSIC		
S 1300DL (B&S - 12,5 HP)	JR19	CLASSIC		
T 1600 (B & S - OHV - 16 HP)	DR17YC	SUPER	DR17YS	SILVER
TCP 102 (B & S - 12,5 HP)	JR19	CLASSIC		
Triple M (8 HP)	JR19	CLASSIC		
Triple M (12 HP)	DR17YC	SUPER	DR17YS	SILVER

MOTOROVÉ PÍLY • CHAINSAW • МОТОПИЛЫ

935X, 942, 951, 962, 980	0,5	PR17Y	CLASSIC	PR17YC	SUPER
HT 22S		PR17	CLASSIC		
XC 42P		TR14C	SUPER	TR14S	SILVER
XC 350		TR14C	SUPER	TR14S	SILVER

MOTOROVÉ TRAVNÍ SEKAČKY • LAWN MOWER • СЕНОКОСИЛКИ

433BP, 440BP		PR17Y	CLASSIC	PR17YC	SUPER
733, 735, 740, 750		PR17Y	CLASSIC	PR17YC	SUPER
Bilama 375		JR19	CLASSIC		
BSK 96		JR19	CLASSIC		
BST 97		JR19	CLASSIC		
Emblem		JR19	CLASSIC		
Jupiter, Jupiter SP		JR19	CLASSIC		
Mirage SP		JR19	CLASSIC		
NP 534TR, NP 534TR3S, NP 534TR3SE		JR19	CLASSIC		
R 434, R 484, R 484TR, R 534TR		JR19	CLASSIC		
Sparta 26TR, Sparta 720, Sparta 721		PR17Y	CLASSIC	PR17YC	SUPER
Sparta 722, Sparta 726		PR17Y	CLASSIC	PR17YC	SUPER
T 534R, T 534RE		JR19	CLASSIC		
TDL 484TR		JR19	CLASSIC		
Toro 5 SP, Toro 48 SP, Toro 880 SP		JR19	CLASSIC		

NISSAN

ELEKTROCENTRÁLY / STACIONÁRNÍ MOTORY • ELEKTROCENTRALS / STATIONARY ENGINES • ЭЛЕКТРИЧЕСКИЕ КОММУТАТОРЫ / СТАЦИОНАРНЫЕ ДВИГАТЕЛИ

D 11		L19	CLASSIC		
H 20		L19	CLASSIC		
H 30		N19C	SUPER		
J 15		L19	CLASSIC		
MA 10		L19	CLASSIC		
P 40		L19	CLASSIC		

OLEO-MAC (EМАК)

KŘOVINOŘEZY • BRUSH CUTTERS • ТРИММЕРЫ

433BP	0,5	PR17Y	CLASSIC	PR17YC	SUPER
721, 727, 727S, 727T, 733, 733S	0,5	PR17Y	CLASSIC	PR17YC	SUPER

MOTOROVÉ PÍLY • CHAINSAW • МОТОПИЛЫ

233, 234, 234F, 240, 244, 244F, 246FDL, 250A	0,5	PR17Y	CLASSIC	PR17YC	SUPER
251, 251B, 251 Super E1, 252, 252F, 254, 254F	0,5	PR17Y	CLASSIC	PR17YC	SUPER
260 Auto., 261, 264, 264F, 264FDLX, 264TTA	0,5	PR17Y	CLASSIC	PR17YC	SUPER
271, 272, 272F, 274TTA, 280, 281, 284, 284F, 284TTA	0,5	PR17Y	CLASSIC	PR17YC	SUPER
335, 340, 340F, 350, 350S, 355F	0,5	PR17Y	CLASSIC	PR17YC	SUPER
460S, 460AS, 480, 480S, 480AS, 481, 482, 482MP	0,5	PR17Y	CLASSIC	PR17YC	SUPER
930, 935, 935DF, 940, 942, 945, 945AF, 945DF, 946	0,5	PR17Y	CLASSIC	PR17YC	SUPER



OLEO-MAC (EMAK)

MOTOROVÉ PILY • CHAINSAW • МОТОПИЛЫ

950, 950F, 950AF, 950FS, 951, 999, 999F	0,5	PR17Y	CLASSIC	PR17YC	SUPER
AM150, AM180	0,5	PR17Y	CLASSIC	PR17YC	SUPER
S30, S50, S80, S100	0,5	PR17Y	CLASSIC	PR17YC	SUPER
SA18, SA30, SA30TL, SA45, SA45TL	0,5	PR17Y	CLASSIC	PR17YC	SUPER
SC21, SC23, SC33, SC55	0,5	PR17Y	CLASSIC	PR17YC	SUPER

ONAN

ELEKTROCENTRÁLY / STACIONÁRNÍ MOTORY • ELEKTROCENTRALS / STATIONARY ENGINES • ЭЛЕКТРИЧЕСКИЕ КОММУТАТОРЫ / СТАЦИОНАРНЫЕ ДВИГАТЕЛИ

0.3 TL - 212R / 1A	0,5	J17	CLASSIC		
1.0 B		L15C ^{+R}	SUPER		
2.7 AJ Spec. K - N		PR17	CLASSIC		
2.8 Micro	0,5	NR17YC	SUPER		
3.0 AJ	0,6	GR17YC	SUPER	GR17YS	SILVER
4.0 BGD/E	0,6	GR17YC	SUPER	GR17YS	SILVER
4.0 Micro	0,6	LR17YC	SUPER	LR17YS	SILVER
4.5 MCE - Marine	0,6	GR17YC	SUPER	GR17YS	SILVER
6.5 MCE - Marine	0,6	GR17YC	SUPER	GR17YS	SILVER
6.5 NHD, NHDE, NHE	0,6	GR17YC	SUPER	GR17YS	SILVER
6.5 NH - CR - 16004P	0,6	GR17YC	SUPER	GR17YS	SILVER
6.5 NH - CR - 16004N	0,5	LR15C	SUPER	LR15S	SILVER
6.5 NH Spec. J & K	0,6	LR15C	SUPER	LR15S	SILVER
8.0 MME - Marine		LR17YC	SUPER	LR17YS	SILVER
9.0 MME - Marine	0,6	LR17YC	SUPER	LR17YS	SILVER
C-CK (Natural Gas)		K15YC	SUPER		
C-W		L15C ^{+R}	SUPER		
G-O	0,5	K17C	SUPER		
H-C, H-K, H-N, H-R		L15C ^{+R}	SUPER		
I-C	0,5	K17C	SUPER		
J-T		L15C ^{+R}	SUPER		
K-A, K-B, K-R	0,5	K17C	SUPER		
M-GO, M-PG, M-UK	0,5	K17C	SUPER		
M-TK		L15C ^{+R}	SUPER		
Marquis I, Marquis III	0,6	GR17YC	SUPER	GR17YS	SILVER
N-HC	0,5	LR15C	SUPER	LR15S	SILVER
O-TC	0,5	K17C	SUPER		
Pro 4000, PRO 4000E	0,5	NR17YC	SUPER		
Pro 5000, PRO 5000E, Pro 6000E	0,6	GR17YC	SUPER	GR17YS	SILVER
V-45		L15C ^{+R}	SUPER		
W-4A		L15C ^{+R}	SUPER		
W-IB	0,5	K17C	SUPER		

PARTNER

KŘOVINOŘEZY • BRUSH CUTTERS • ТРИММЕРЫ

B 180, B 250, B 265, B 305, B 322, B 325	0,5	PR18Y	CLASSIC		
B 200, B 205, B 370, B 380, B 400, B 405	0,5	PR17Y	CLASSIC	PR17YC	SUPER
B 440, B 450	0,5	PR17Y	CLASSIC	PR17YC	SUPER
BV 24	0,5	PR18Y	CLASSIC		
GBl 32	0,5	PR18Y	CLASSIC		
HG 55-12	0,5	PR18Y	CLASSIC		
T 180 Colibri, T 210 Colibri Plus	0,5	PR18Y	CLASSIC		

KULTIVÁTORY • CULTIVATORS • КУЛЬТИВАТОРЫ

31		JR19	CLASSIC		
310		JR19	CLASSIC		
511RT		JR19	CLASSIC		
3100		JR19	CLASSIC		
5100, 5110, 5510		JR19	CLASSIC		
P 31		PR18Y	CLASSIC		



service
instructions

... BOSCH ...
... CHAMPION ...
... NGK ...



BRISK

LAST INFO



STANDARD
BRISK

ALTERNATIVE
BRISK

PARTNER

MALOTRAKTORY • TRACTORS • МАЛОГАБАРИТНЫЕ ТРАКТОРЫ

3-51		PR18Y	CLASSIC		
10-90E	0,5	JR17	CLASSIC		
12-90E, 12-95E, 12-100E	0,5	JR17	CLASSIC		

MOTOROVÉ PÍLY • CHAINSAW • МОТОПИЛЫ

330, 335, 340, 350, 385	0,5	P17	CLASSIC		
345, 360, 365, 395	0,5	PR17Y	CLASSIC	PR17YC	SUPER
400, 405, 450	0,5	PR17Y	CLASSIC	PR17YC	SUPER
465, 495	0,5	P15	CLASSIC		
500, 500 Plus, 550	0,5	PR17Y	CLASSIC	PR17YC	SUPER
545	0,5	P15	CLASSIC		
605	0,5	PR15Y	CLASSIC	PR17YC	SUPER
650	0,5	PR17Y	CLASSIC	PR17YC	SUPER
1601, 1602, 1618C	0,5	PR17Y	CLASSIC	PR17YC	SUPER
5000, 5500	0,5	PR17Y	CLASSIC	PR17YC	SUPER
7000 Plus, 7700	0,5	PR17Y	CLASSIC	PR17YC	SUPER
A 55	0,5	PR17Y	CLASSIC	PR17YC	SUPER
F 55	0,5	PR17Y	CLASSIC	PR17YC	SUPER
K 12		N15YC	SUPER		
K 20, K 40		P17	CLASSIC		
P 48, P 49, P 50, P 51, P 55, P 59, P 65	0,5	PR17Y	CLASSIC	PR17YC	SUPER
P 70, P 85, P 100, P 100S	0,5	PR17Y	CLASSIC	PR17YC	SUPER
P 350, P 351, P 370, P 400	0,5	PR17Y	CLASSIC	PR17YC	SUPER
P 410CCS, P 460CCS, P 510CCS, P 540CCS	0,5	PR17Y	CLASSIC	PR17YC	SUPER
P 660CCS, P 710CCS	0,5	PR17Y	CLASSIC	PR17YC	SUPER
P 5000 Plus	0,5	PR17Y	CLASSIC	PR17YC	SUPER
Partner Mini III, Partner Mini IV		U17	CLASSIC		
R 11, R 12, R 14, R 16, R 17, R 18, R 19	0,5	PR17Y	CLASSIC	PR17YC	SUPER
R 20, R 35	0,5	PR17Y	CLASSIC	PR17YC	SUPER
R 22, R 22T, R 40T, R 117	0,5	PR17Y	CLASSIC	PR17YC	SUPER
R 30		P17	CLASSIC		
R 417T, R 420T, R 421, R 435, R440T, R 523	0,5	PR17Y	CLASSIC	PR17YC	SUPER
R 421T, R 440T, R 517, R 517T		P15	CLASSIC		
S 50, S 55, S 65	0,5	PR17Y	CLASSIC	PR17YC	SUPER

MOTOROVÉ TRAVNÍ SEKAČKY • LAWN MOWER • СЕНОКОСИЛКИ

P 150D, P 150DE, P 350		JR19	CLASSIC		
------------------------	--	------	---------	--	--

PIVA MOTOR

KULTIVÁTORY • CULTIVATORS • КУЛЬТИВАТОРЫ

M 6, M 9, M 9B, M 9X, M10	0,5	N17C	SUPER		
MA 43, MA 43A	0,5	N15C	SUPER	NR15S	SILVER
MA 54	0,5	N17C	SUPER		
MC 9.60S, MC 9.60X, MC 60	0,5	N17C	SUPER		
MC 43, MC 43A	0,5	N15C	SUPER	NR15S	SILVER

MOTOROVÉ TRAVNÍ SEKAČKY • LAWN MOWER • СЕНОКОСИЛКИ

CC 1, CC 3, CC 4, CC 43-41	0,5	N17C	SUPER		
CC 54-50	0,5	N17C	SUPER		
CCS 54-50	0,5	N17C	SUPER		

POULAN

MOTOROVÉ PÍLY • CHAINSAW • МОТОПИЛЫ

20, 20D, 25, 25CVA, 25DA, 71A, 72, 76, 92		P17	CLASSIC		
53A, 54		K19	CLASSIC		
100, 205, 225, 235, 245A, 252A		P17	CLASSIC		
306, 306A, 306SA, 361		P17	CLASSIC		
285		P17Y	CLASSIC	PR17YC	SUPER
325		U17	CLASSIC		
335		P15	CLASSIC		
355, 375, 395, 405, 415		P17Y	CLASSIC	PR17YC	SUPER



STANDARD
BRISK

ALTERNATIVE
BRISK

POULAN

MOTOROVÉ PILY • CHAINSAW • МОТОПИЛЫ

455, 475, 525, 655		P17Y	CLASSIC	PR17YC	SUPER
1800, 2000, 2300		P17	CLASSIC		
3400, 3700 / (1980-)		PR17Y	CLASSIC	PR17YC	SUPER
4200, 5200 / (-1980)		P17	CLASSIC		
4200 (1980-), 4400, 4900, 5200 (1980-), 5400		P15	CLASSIC		
4200CVA, 6000CVA		PR17Y	CLASSIC	PR17YC	SUPER
5200CVA		P17	CLASSIC		
5500, 6000, 6900, 7700, 8500		P15	CLASSIC		
6000xx		K19	CLASSIC		
M 25		P17	CLASSIC		
Micro 255N, Micro MZ5		P17	CLASSIC		
S 25		P17Y	CLASSIC	PR17YC	SUPER
S 25AV, S 25DA		P17	CLASSIC		
S 33		K19	CLASSIC		
S 68, S 72		P17	CLASSIC		
S 6000		PR17Y	CLASSIC	PR17YC	SUPER
Super XXV		P17	CLASSIC		

QUALCAST

KULTIVÁTOŘY • CULTIVATORS • КУЛЬТИВАТОРЫ

Super (98ccm)	0,5	K19	CLASSIC		
De Luxe (4 HP)		P17	CLASSIC		

REFORMWERKE BAUER

MALOTRAKTORY • TRACTORS • МАЛОГАБАРИТНЫЕ ТРАКТОРЫ

Reform 112, Reform 115 / (7-7,5 HP)	0,5	N19C	SUPER		
Reform 131 (7-7,5 HP)	0,5	N19C	SUPER		

SACHS

ELEKTROCENTRÁLY / STACIONÁRNÍ MOTORY • ELEKTROCENTRALS / STATIONARY ENGINES • ЭЛЕКТРИЧЕСКИЕ КОММУТАТОРЫ / СТАЦИОНАРНЫЕ ДВИГАТЕЛИ

Famo 50	0,5	N19C	SUPER		
Famo 50/1 M I	0,5	N19C	SUPER		
Famo 50/1 MA SF	0,5	N19C	SUPER		
Famo 50/1 MA X	0,5	N14C	SUPER	NR14S	SILVER
Famo 50/1 MB	0,5	N14C	SUPER	NR14S	SILVER
Famo 50/2 C	0,5	N19C	SUPER		
Famo 50/2 D NL	0,5	N15C	SUPER	NR15S	SILVER
Famo 50/2 DK	0,5	N19C	SUPER		
Famo 50/2 K DK	0,5	N19C	SUPER		
Famo 50/2 K S	0,5	N19C	SUPER		
Famo 50/2 MA NL	0,5	N15C	SUPER	NR15S	SILVER
Famo 50/2 MA SF	0,5	N15C	SUPER	NR15S	SILVER
Famo 50/2 MA X	0,5	N14C	SUPER	NR14S	SILVER
Famo 50/2 MAK SF	0,5	N15C	SUPER	NR15S	SILVER
Famo 50/2 MB, ML B	0,5	N14C	SUPER	NR14S	SILVER
Famo 50/2 ML C	0,5	N19C	SUPER		
Famo 50/2 MLA X	0,5	N15C	SUPER	NR15S	SILVER
Famo 50/2 S	0,5	N19C	SUPER		
Famo 50/3 LFH	0,5	N14C	SUPER	NR14S	SILVER
Famo 50/4 DF X	0,5	N14C	SUPER	NR14S	SILVER
Famo 50/4 LK S	0,5	N19C	SUPER		
Famo 50/4 LKH	0,5	N14C	SUPER	NR14S	SILVER
Famo 50/4 MLFA NL	0,5	N14C	SUPER	NR14S	SILVER
Famo 50/4 MLFB	0,5	N14C	SUPER	NR14S	SILVER
Famo 50/4 MLKA X	0,5	N14C	SUPER	NR14S	SILVER
Famo 50/5 AKF	0,5	NR12YC	SUPER		
Famo 50/5 WKF	0,5	L14C	SUPER	LR14S	SILVER
Famo 50/ADL X	0,5	N14C	SUPER	NR14S	SILVER
Famo 50/AE X	0,5	N14C	SUPER	NR14S	SILVER



service
instructions

... BOSCH ...
... CHAMPION ...
... NGK ...



BRISK

LAST INFO



STANDARD
BRISK

ALTERNATIVE
BRISK

SACHS

ELEKTROCENTRÁLY / STACIONÁRNÍ MOTORY • ELEKTROCENTRALS / STATIONARY ENGINES • ЭЛЕКТРИЧЕСКИЕ КОММУТАТОРЫ / СТАЦИОНАРНЫЕ ДВИГАТЕЛИ

Famo 50/AL S	0,5	N15C	SUPER	NR15S	SILVER
Famo 50/AM A	0,5	N14C	SUPER	NR14S	SILVER
Famo 50/AM B	0,5	N14C	SUPER	NR14S	SILVER
Famo 50/AMA I	0,5	N15C	SUPER	NR15S	SILVER
Famo 50/AMA SF	0,5	N15C	SUPER	NR15S	SILVER
Famo 50/AMA X	0,5	N14C	SUPER	NR14S	SILVER
Famo 50/AMAL X	0,5	N14C	SUPER	NR14S	SILVER
Famo 50/AML	0,5	N15C	SUPER	NR15S	SILVER
Famo 50/AML C	0,5	N19C	SUPER		
Famo 50/AML S	0,5	N15C	SUPER	NR15S	SILVER
Famo 50/MC	0,5	N19C	SUPER		
Famo 501/3 BF	0,5	N15C	SUPER	NR15S	SILVER
Famo 501/4 AKF X	0,5	N14C	SUPER	NR14S	SILVER
Famo BF	0,5	N15C	SUPER	NR15S	SILVER
Famo BKF	0,5	N15C	SUPER	NR15S	SILVER
Famo CKF	0,5	N15C	SUPER	NR15S	SILVER
Famo 503 ABLCH	0,5	N14C	SUPER	NR14S	SILVER
Famo 504/1 A	0,5	N15C	SUPER	NR15S	SILVER
Famo 504/1 ADK	0,5	N15C	SUPER	NR15S	SILVER
Famo 504/1 ANL	0,5	N15C	SUPER	NR15S	SILVER
Famo 504/1 B	0,5	N15C	SUPER	NR15S	SILVER
Famo 504/1 BS	0,5	N15C	SUPER	NR15S	SILVER
Famo 505/1 A	0,5	N15C	SUPER	NR15S	SILVER
Famo 505/1 A NL	0,5	N15C	SUPER	NR15S	SILVER
Famo 505/1 BS,BX	0,5	N15C	SUPER	NR15S	SILVER
Famo 505/1 C	0,5	N15C	SUPER	NR15S	SILVER
Famo 505/1 D,DK	0,5	N15C	SUPER	NR15S	SILVER
Famo 505/1 USA	0,5	N15C	SUPER	NR15S	SILVER
Famo 505/2 A NL	0,5	N15C	SUPER	NR15S	SILVER
Famo 505/2 AK SF	0,5	N15C	SUPER	NR15S	SILVER
Famo 505/2 AKS	0,5	N15C	SUPER	NR15S	SILVER
Famo 505/2 BS,BX	0,5	N15C	SUPER	NR15S	SILVER
Famo 505/2 C	0,5	N15C	SUPER	NR15S	SILVER
Famo 505/2 CK	0,5	N15C	SUPER	NR15S	SILVER
Famo 505/2 D	0,5	N15C	SUPER	NR15S	SILVER
Famo 505/2 DK	0,5	N15C	SUPER	NR15S	SILVER
Famo 505/3 BX	0,5	N15C	SUPER	NR15S	SILVER
Famo 505/3 D,DK	0,5	N15C	SUPER	NR15S	SILVER
Famo 506/3 B	0,5	N15C	SUPER	NR15S	SILVER
Famo 506/4 AKF	0,5	N15C	SUPER	NR15S	SILVER
Famo 535/1 ACH	0,5	N14C	SUPER	NR14S	SILVER
Famo 1251/5 A (12,5 HP)	0,5	N14C	SUPER	NR14S	SILVER
Famo 1251/5 AL	0,5	N14C	SUPER	NR14S	SILVER
Famo 1251/5 B	0,5	N14C	SUPER	NR14S	SILVER
KM 37	0,5	N17C	SUPER		
KM 37	0,5	N15C	SUPER	NR15S	SILVER
KM 48,Famo 508	0,5	N17C	SUPER		
KM 48	0,5	N15C	SUPER	NR15S	SILVER
KM 48-K 8 B	0,5	N17C	SUPER		
KM 48-K 8 B	0,5	N15C	SUPER	NR15S	SILVER
KM 914 A	0,5	N17C	SUPER		
SB 102	0,5	N17C	SUPER		
SB 125	0,5	N19C	SUPER		
SB 125	0,5	N17C	SUPER		
SB 150	0,5	N19C	SUPER		
SB 150	0,5	N17C	SUPER		



SACHS

ELEKTROCENTRÁLY / STACIONÁRNÍ MOTORY • ELEKTROCENTRALS / STATIONARY ENGINES • ЭЛЕКТРИЧЕСКИЕ КОММУТАТОРЫ / СТАЦИОНАРНЫЕ ДВИГАТЕЛИ

SB 151,A,B	0,5	N17C	SUPER		
Stamo 76 RM	0,5	N15C	SUPER	NR15S	SILVER
Stamo ST 30	0,5	N19C	SUPER		
Stamo ST 30	0,5	N15C	SUPER	NR15S	SILVER
Stamo ST 51	0,5	NR12YC	SUPER		
Stamo ST 76 (1,2 kW)	0,5	N19C	SUPER		
Stamo ST 76 (1,2 kW)	0,5	N15C	SUPER	NR15S	SILVER
Stamo ST 76 (2 kW)	0,5	N19C	SUPER		
Stamo ST 76 (2 kW)	0,5	N15C	SUPER	NR15S	SILVER
Stamo ST 76 F,S,G	0,5	N19C	SUPER		
Stamo ST 76 F,S,G	0,5	N15C	SUPER	NR15S	SILVER
Stamo ST 96 (06.86-)	0,5	N15C	SUPER	NR15S	SILVER
Stamo ST 96	0,5	N14C	SUPER	NR14S	SILVER
Stamo 96 F,S,G,GS,SL-2	0,5	N15C	SUPER	NR15S	SILVER
Stamo 96 F,S,G,GG	0,5	N14C	SUPER	NR14S	SILVER
Stamo ST 125	0,5	N19C	SUPER		
Stamo 125	0,5	N17C	SUPER		
Stamo ST 150	0,5	N19C	SUPER		
Stamo ST 150	0,5	N17C	SUPER		
Stamo ST 151	0,5	N17C	SUPER		
Stamo ST 151	0,5	N14C	SUPER	NR14S	SILVER

SEARS

KŘOVINOŘEZY • BRUSH CUTTERS • ТРИММЕРЫ

271.281514		P17	CLASSIC		
610.281514, 611.281514		P17	CLASSIC		

MOTOROVÉ PILY • CHAINSAW • МОТОПИЛЫ

1.9 PS		P17	CLASSIC		
1.9 Beaver		U15	CLASSIC		
2.0, 2.1A		P17	CLASSIC		
2.5		U15	CLASSIC		
3.5/20		U15	CLASSIC		
3.6		P17	CLASSIC		
3.7, 3.7A, 3.7PS		P15	CLASSIC		
4.5/23		U15	CLASSIC		
271-1.8, 271-2.7A, 271-2.7VL		P17	CLASSIC		
271-4.3A, 271-4.3VL		P17	CLASSIC		
3400, 3401, 3402, 3408, 3411, 3412, 3415, 3416		P17	CLASSIC		
3418, 3425, 3455, 3460, 3461, 3465, 3466, 3476		P17	CLASSIC		
3481		P17	CLASSIC		
31197		P15	CLASSIC		
34071, 34094, 35082, 35091, 35093, 35094		P17	CLASSIC		
34180		U17	CLASSIC		
35096, 35201, 35202, 35203, 35205, 35206		P17	CLASSIC		
35138, 35147, 35148, 35171, 35177, 35187		P15	CLASSIC		
35207, 35209, 35211, 35232, 35238, 35251		P17	CLASSIC		
35255, 35256, 35263, 35266, 35267		P17	CLASSIC		
35269, 35365, 35505		U17	CLASSIC		
35363, 35366, 35367, 35369, 35371		P17	CLASSIC		
35372, 35373, 35375, 35376, 35607		P15	CLASSIC		
35481, 35483, 35487		P17Y	CLASSIC	PR17YC	SUPER
35484, 35608, 35609, 35885		P17Y	CLASSIC	PR17YC	SUPER
35505, 35506, 35512, 35514, 35515, 35516		P17	CLASSIC		
35628, 35633, 35718		P15	CLASSIC		
35881		P17Y	CLASSIC	PR17YC	SUPER
35887, 35889, 35904		P15	CLASSIC		
36096, 36212, 36235		P17	CLASSIC		



service instructions

... BOSCH ...
... CHAMPION ...
... NGK ...



LAST INFO

**STANDARD
BRISK**
**ALTERNATIVE
BRISK**
SEARS
MOTOROVÉ PÍLY • CHAINSAW • МОТОПИЛЫ

59716, 59741, 59816, 59886	P17	CLASSIC		
352030, 352060, 352070, 352092, 352321	P17	CLASSIC		
352351, 357120, 357160, 358860	P17	CLASSIC		
358810	P15	CLASSIC		
358840, 35883, 35886	P15	CLASSIC		
358850	P17Y	CLASSIC	PR17YC	SUPER
Barracuda	P15	CLASSIC		
D 44, D 49	K19	CLASSIC		

SHINDAIWA
KŘOVINOŘEZY • BRUSH CUTTERS • ТРИММЕРЫ

B 40, B 45	P17	CLASSIC		
BP 35	P17	CLASSIC		
C 20, C 25, C 35	P17	CLASSIC		
F 18, F 20, F21	P17	CLASSIC		
T 18, T 20, T 25	P17	CLASSIC		
T 2500 (USA)	TR15C	SUPER		

MOTOROVÉ PÍLY • CHAINSAW • МОТОПИЛЫ

300, 345, 350, 355, 415, 416	PR17Y	CLASSIC	PR17YC	SUPER
360, 488	P15Y	CLASSIC	PR17YC	SUPER
420, 450, 451, 460, 500, 510	PR17Y	CLASSIC	PR17YC	SUPER
575, 580, 680, 695	PR17Y	CLASSIC	PR17YC	SUPER

SIMPLICITY
MALOTRAKTORY • TRACTORS • МАЛОГАБАРИТНЫЕ ТРАКТОРЫ

4210, 4212	JR19	CLASSIC		
------------	------	---------	--	--

SNAPPER
KULTIVÁTORY • CULTIVATORS • КУЛЬТИВАТОРЫ

505, 507, 527, 528, 534, 565, 566	0,5	N17C	SUPER	
506	0,5	P17	CLASSIC	
B & S		JR19	CLASSIC	

MALOTRAKTORY • TRACTORS • МАЛОГАБАРИТНЫЕ ТРАКТОРЫ

B & S	JR19	CLASSIC		
-------	------	---------	--	--

MOTOROVÉ TRAVNÍ SEKAČKY • LAWN MOWER • СЕНОКОСИЛКИ

B & S	J19	CLASSIC		
Kawasaki (5 HP)	L17YC	SUPER	LR17YS	SILVER
Tecumseh	0,8	K19	CLASSIC	

SOLO
ELEKTROCENTRÁLY / STACIONÁRNÍ MOTORY • ELEKTROCENTRALS / STATIONARY ENGINES • ЭЛЕКТРИЧЕСКИЕ КОММУТАТОРЫ / СТАЦИОНАРНЫЕ ДВИГАТЕЛИ

100 Mu, 101 Mu	0,5	P15	CLASSIC	
236	0,5	N19C	SUPER	
237,272	0,5	N15C	SUPER	NR15S SILVER
400	0,5	P17	CLASSIC	
410, 410B, 412, 412B	0,5	N17C	SUPER	
414, 422	0,5	PR15Y	CLASSIC	PR17YC SUPER
415, 420		U17Y	CLASSIC	
419, 419 Trac, 423, 423B, 424, 426	0,5	N17C	SUPER	
426 Minor, 436, 436 Minor, 437, 437 Rider	0,5	N15C	SUPER	NR15S SILVER
439, 439 Trac, 439/30 Trac, 439/50, 440	0,5	N15C	SUPER	NR15S SILVER
440/4, 441, 444, 445, 450, 471, 472	0,5	PR15Y	CLASSIC	PR17YC SUPER
449, 449L, 459, 459 Modular Unit	0,5	N15C	SUPER	NR15S SILVER
501 (2Takt - SOLO)		PR17Y	CLASSIC	PR17YC SUPER
501 (4Takt - Honda), 502		NAR15YS	SILVER	
503		JR19	CLASSIC	
504, 508		LR15YC	SUPER	LR15YS SILVER
505, 528, 534, 583	0,5	N19C	SUPER	
520, 565, 566	0,5	N15C	SUPER	NR15S SILVER
522	0,5	P15	CLASSIC	



STANDARD
BRISK

ALTERNATIVE
BRISK

SOLO

ELEKTROCENTRÁLY / STACIONÁRNÍ MOTORY • ELEKTROCENTRALS / STATIONARY ENGINES • ЭЛЕКТРИЧЕСКИЕ КОММУТАТОРЫ / СТАЦИОНАРНЫЕ ДВИГАТЕЛИ

554	0,5	K17C	SUPER		
830	0,5	N19C	SUPER		
837	0,5	N17C	SUPER		

KŘOVINOŘEZY • BRUSH CUTTERS • ТРИММЕРЫ

101, 105L, 106B, 106L		PR17Y	CLASSIC	PR17YC	SUPER
106R		SR15C	SUPER		
117, 118, 119, 119B, 119L, 120		PR15Y	CLASSIC	PR17YC	SUPER
121, 121B, 121L, 124, 126, 127		PR15Y	CLASSIC	PR17YC	SUPER
123, 125	0,5	U17	CLASSIC		
127B, 127L, 128, 130		PR18Y	CLASSIC		
127H, 130H	0,5	NAR15YS	SILVER		
129, 129BTS, 129L		PR15Y	CLASSIC	PR17YC	SUPER
132, 134, 137, 140, 141, 152, 153		PR18Y	CLASSIC		
135, 136	0,5	P17	CLASSIC		
664		PR17Y	CLASSIC	PR17YC	SUPER

KULTIVÁTORY • CULTIVATORS • КУЛЬТИВАТОРЫ

505, 507, 510		N17C	SUPER		
506		P17	CLASSIC		
B & S - 3,5 HP		JR19	CLASSIC		
Honda - 1,5 HP		NAR15YS	SILVER		
Honda - 5 HP		LR17YC	SUPER	LR17YS	SILVER

MALOTRAKTORY • TRACTORS • МАЛОГАБАРИТНЫЕ ТРАКТОРЫ

B & S - 10,5 HP, 13 HP, 15,5 HP		JR19	CLASSIC		
B & S - 18 HP, 20 HP / Intek		DR17YC	SUPER	DR17YS	SILVER

MOTOROVÉ PILY • CHAINSAW • МОТОПИЛЫ

600B, 600 Mini	0,5	PR17Y	CLASSIC	PR17YC	SUPER
603	0,5	PR15Y	CLASSIC	PR17YC	SUPER
605 (-1984), 605AV, 606 (-1984), 606AV, 610AV	0,5	PR17Y	CLASSIC	PR17YC	SUPER
611, 615AV (-1980), 616 (-1980), 616AV, 620AV	0,5	PR15Y	CLASSIC	PR17YC	SUPER
626	0,5	N17C	SUPER		
630, 632	0,5	K17C	SUPER		
633, 634, 635, 636, 638, 639, 639D, 640, 640C	0,5	PR15Y	CLASSIC	PR17YC	SUPER
641, 642, 644, 644H, 644SP, 644VA	0,5	PR15Y	CLASSIC	PR17YC	SUPER
642 (-1978)	0,5	P17	CLASSIC		
645, 645D, 647	0,5	PR15Y	CLASSIC	PR17YC	SUPER
650VA (-1984)	0,5	P18Y	CLASSIC		
650, 650AV, 651, 651SP, 654, 655AV, 660AV	0,5	PR17Y	CLASSIC	PR17YC	SUPER
655AV (-1984)	0,5	P18Y	CLASSIC		
662, 667, 667W, 670, 673, 675, 680, 680W	0,5	PR15Y	CLASSIC	PR17YC	SUPER
690, 690D, 690WD, 694	0,5	PR15Y	CLASSIC	PR17YC	SUPER
Twin 100	0,5	K17C	SUPER		

MOTOROVÉ TRAVNÍ SEKAČKY • LAWN MOWER • СЕНОКОСИЛКИ

102, 103, 106, 107, 110, 111, 114	0,5	P15	CLASSIC		
518 (Honda - 4 HP)		LR17YC	SUPER	LR17YS	SILVER
520, 522x	0,5	NR17C	SUPER		
522 (B & S)	0,5	PR17	CLASSIC		
530, 531 (1998-1999)	0,5	JR19	CLASSIC		
531 (1999-2000), 532		LR15YC	SUPER	LR15YS	SILVER
543, 543L	0,5	N17C	SUPER		
545, 545R	0,5	JR19	CLASSIC		
546, 546R, 546RS, 551, 551R, 553, 553S		JR19	CLASSIC		
546HR, 546HRM, 550H, 550HR, 550HRM		LR17YC	SUPER	LR17YS	SILVER
546S, 546RS	0,5	K17C	SUPER		
546Z, 546ZR	0,5	PR17	CLASSIC		
548R		LR17YC	SUPER	LR17YS	SILVER
548Rx, 550, 550R, 550RS, 554		JR19	CLASSIC		



service
instructions

... BOSCH ...
... CHAMPION ...
... NGK ...



BRISK

LAST INFO



**STANDARD
BRISK**

**ALTERNATIVE
BRISK**

SOLO

MOTOROVÉ TRAVNÍ SEKAČKY • LAWN MOWER • СЕНОКОСИЛКИ

549, 549 Piano, 549 Profi	0,5	N17C	SUPER		
551, 551R	0,5	K17C	SUPER		
551ZR	0,5	P15	CLASSIC		
552HR, 553P, 553SL		LR17YC	SUPER	LR17YS	SILVER
552R, 553S		DR17YC	SUPER	DR17YS	SILVER
552Z, 552ZR	0,5	N17C	SUPER		
554, 554L, 554Z	0,5	PR15	CLASSIC		
555, 556, 557, 558, 560, 562, 570, 572		DR17YC	SUPER	DR17YS	SILVER
555 (OHV), 556 (OHV), 557 (OHV), 558 (OHV)		JR19	CLASSIC		
560 (OHV), 562 (OHV)		JR19	CLASSIC		
563, 563L	0,5	N17C	SUPER		
570 (OHV)		JR19	CLASSIC		
575 (OHV), 576 (OHV)		DR17YC	SUPER	DR17YS	SILVER
577, 580, 581, 581 Piano	0,5	N17C	SUPER		
582, 585HM		JR19	CLASSIC		
585	0,5	PR17	CLASSIC		
585 HM		LR17YC	SUPER	LR17YS	SILVER
Aspera		JR17	CLASSIC		
B & S - 3 HP, 3,3 HP, 3,5 HP, 3,75		JR19	CLASSIC		
B & S - 4,5 HP, 5 HP, 5,5 HP, 8 HP		JR19	CLASSIC		
Honda - 3 HP, 4 HP, 4,5 HP		LR17YC	SUPER	LR17YS	SILVER
Honda - 5 HP (OHV), 5,5 HP, 6 HP		LR17YC	SUPER	LR17YS	SILVER

STAR

KULTIVÁTORY • CULTIVATORS • КУЛЬТИВАТОРЫ

2Takt		K19	CLASSIC		
4Takt	0,6	JR19	CLASSIC		

STEINBOCK

MALOTRAKTORY • TRACTORS • МАЛОГАБАРИТНЫЕ ТРАКТОРЫ

All models		LR15YC	SUPER	LR15YS	SILVER
------------	--	--------	-------	--------	--------

STIGA

MALOTRAKTORY • TRACTORS • МАЛОГАБАРИТНЫЕ ТРАКТОРЫ

BA 8, BA 20		K19	CLASSIC		
BB 800		K19	CLASSIC		
Park 2000, Park 2008E		K19	CLASSIC		
Ponny 6, SB 50 Vario-Speed	0,5	P15	CLASSIC		
President		K19	CLASSIC		
RA Dino		K19	CLASSIC		
RB Dino		K19	CLASSIC		
TB 300, TB 500		K19	CLASSIC		
Tornado 300, Tornado 500	0,5	P15	CLASSIC		

STIHL

ELEKTROCENTRÁLY / STACIONÁRNÍ MOTORY • ELEKTROCENTRALS / STATIONARY ENGINES • ЭЛЕКТРИЧЕСКИЕ КОММУТАТОРЫ / СТАЦИОНАРНЫЕ ДВИГАТЕЛИ

1106, 1108, 1109, 1110	0,5	PR15Y	CLASSIC	PR17YC	SUPER
1111	0,5	PR17Y	CLASSIC	PR17YC	SUPER
1112, 1113	0,5	PR15Y	CLASSIC	PR17YC	SUPER
4309	0,5	N15YC	SUPER		

KŘOVINOŘEZY • BRUSH CUTTERS • ТРИММЕРЫ

BG 17	0,5	PR17Y	CLASSIC	PR17YC	SUPER
BG 45, BG 55, BG 60, BG 61, BG 75, BG 85	0,5	PR15Y	CLASSIC	PR17YC	SUPER
BG 72	0,5	PR18Y	CLASSIC		
BR 45C	0,5	PR15Y	CLASSIC	PR17YC	SUPER
BR 106	0,5	PR18Y	CLASSIC		
BR 320, BR 320L, BR 400	0,5	PR17Y	CLASSIC	PR17YC	SUPER
BR 380	0,5	PR15Y	CLASSIC	PR17YC	SUPER
BR 500, BR 550, BR 600		TR15C	SUPER		
FC 44, FC 50, FC72, FC 75	0,5	PR15Y	CLASSIC	PR17YC	SUPER



STIHL

KŘOVINOŘEZY • BRUSH CUTTERS • ТРИММЕРЫ

FC 100, FC 110		TR15C	SUPER		
FH 75	0,5	PR15Y	CLASSIC	PR17YC	SUPER
FR 85, FR 106, FR 108, FR 350, FR 450, FR 480	0,5	PR15Y	CLASSIC	PR17YC	SUPER
FS 25-4, FS 25-4R		TR15C	SUPER		
FS 20	0,5	PR15Y	CLASSIC	PR17YC	SUPER
FS 36, FS 38, FS 40, FS 44, FS 44J, FS 44R	0,5	PR17	CLASSIC		
FS 45, FS 45C, FS 48	0,5	PR15Y	CLASSIC	PR17YC	SUPER
FS 50, FS 51	0,5	PR17	CLASSIC		
FS 52, FS 55, FS 55C, FS 55R, FS 55RC	0,5	PR15Y	CLASSIC	PR17YC	SUPER
FS 56, FS 56AVRE, FS 60, FS 61, FS 65	0,5	PR17	CLASSIC		
FS 62	0,5	PR15Y	CLASSIC	PR17YC	SUPER
FS 65-4, FS 65-4R		TR15C	SUPER		
FS 66	0,5	PR18Y	CLASSIC		
FS 72, FS 74, FS 74AVE, FS 74AVRE, FS 75	0,5	PR18Y	CLASSIC		
FS 76AVE, FS 76AVRE, FS 80, FS 80R, FS 81	0,5	PR18Y	CLASSIC		
FS 85, FS 85R, FS 85RT, FS 85T, FS 86AVRE	0,5	PR18Y	CLASSIC		
FS 86 (- 14821680)	0,5	PR17	CLASSIC		
FS 86 (15821680-), FS 88, FS 88AVE, FS 88AVRE	0,5	PR18Y	CLASSIC		
FS 90 (Typ 4117), FS 96	0,5	PR17	CLASSIC		
FS 90 (Series "NEW")		TR15C	SUPER		
FS 100, FS 100R, FS 100RX		TR15C	SUPER		
FS 106, FS 106AVE, FS 108, FS 120	0,5	PR18Y	CLASSIC		
FS 110, FS 130		TR15C	SUPER		
FS 150, FS 151, FS 160, FS 180, FS 200, FS 200AV	0,5	PR15Y	CLASSIC	PR17YC	SUPER
FS 200AVE, FS 202, FS 202AV, FS 220, FS 280	0,5	PR15Y	CLASSIC	PR17YC	SUPER
FS 280K, FS 300, FS 350, FS 400, FS 400K	0,5	PR15Y	CLASSIC	PR17YC	SUPER
FS 353, FS 353AV	0,5	NR15YC	SUPER		
FS 360AVEZ	0,5	PR15Y	CLASSIC	PR17YC	SUPER
FS 410, FS 410AVE	0,5	PR17Y	CLASSIC	PR17YC	SUPER
FS 420, FS 450, FS 450K, FS 480, FS 480K	0,5	PR15Y	CLASSIC	PR17YC	SUPER
FS 500, FS 550	0,5	PR15Y	CLASSIC	PR17YC	SUPER
HS 75	0,5	PR15Y	CLASSIC	PR17YC	SUPER
HT 70, HT 75	0,5	PR15Y	CLASSIC	PR17YC	SUPER
HT 101, HT 131		TR15C	SUPER		
HTR 85	0,5	PR15Y	CLASSIC	PR17YC	SUPER
KM 100FS, KM 100RFS, KM 100RHL, KM 100RHT		TR15C	SUPER		
KM 55CFS, KM 55FS, KM 55RFS, KM 55RHL	0,5	PR15Y	CLASSIC	PR17YC	SUPER
KM 55RHT, KM 55RCFS, KM 55RHL, KM 55RHT	0,5	PR15Y	CLASSIC	PR17YC	SUPER
KM 85FS, KM 85RFS, KM 85RHL, KM 85RHT	0,5	PR15Y	CLASSIC	PR17YC	SUPER
KM 90, KM 90R, KM 130, KM 130R		TR15C	SUPER		
KW 85	0,5	PR15Y	CLASSIC	PR17YC	SUPER
MM 55	0,5	PR15Y	CLASSIC	PR17YC	SUPER
SC17	0,5	PR15Y	CLASSIC	PR17YC	SUPER
SG17	0,5	PR17Y	CLASSIC	PR17YC	SUPER
SH 55, SH 85	0,5	PR15Y	CLASSIC	PR17YC	SUPER
SR 320, SR 340, SR 400, SP 420	0,5	PR17Y	CLASSIC	PR17YC	SUPER
TS 360, TS 400, TS 460	0,5	PR15Y	CLASSIC	PR17YC	SUPER

KULTIVÁTORY • CULTIVATORS • КУЛЬТИВАТОРЫ

Drill - 08S Power Heads	0,5	NR15YC	SUPER		
Drill - 020, Drill - 045 / Power Heads	0,5	PR15Y	CLASSIC	PR17YC	SUPER
Drill - BT 106C	0,5	PR18Y	CLASSIC		
Drill - BT 121	0,5	PR15Y	CLASSIC	PR17YC	SUPER
Drill - BT 308, Drill - BT 309	0,5	NR15YC	SUPER		
Drill - BT 360	0,5	PR15Y	CLASSIC	PR17YC	SUPER
Super Rake	0,5	PR17	CLASSIC		





**STANDARD
BRISK**

**ALTERNATIVE
BRISK**

STIHL

MOTOROVÉ PILY • CHAINSAW • МОТОПИЛЫ

006, 007, 007S, 008, 008H	0,5	N15YC	SUPER		
008S	0,5	N15C	SUPER	NR15S	SILVER
009, 009AV, 009L, 009EQZ, 009 Mini Boss	0,5	PR15Y	CLASSIC	PR17YC	SUPER
010, 010AV, 011, 011AV, 011AVTEQ, 011T	0,5	PR15Y	CLASSIC	PR17YC	SUPER
015, 015AV, 015AVE, 015AVP, 015AVS, 015L	0,5	PR15Y	CLASSIC	PR17YC	SUPER
015LE, 015R, 017, 018C, 019T	0,5	PR15Y	CLASSIC	PR17YC	SUPER
020, 020AV, 020AVEP, 020AVH, 020AVP, 020AVT	0,5	PR15Y	CLASSIC	PR17YC	SUPER
020T, 021, 021 Wood Boss	0,5	PR15Y	CLASSIC	PR17YC	SUPER
023, 023AV, 023C, 023L, 023KSS, 023 Wood Boss	0,5	PR15Y	CLASSIC	PR17YC	SUPER
024, 024AV, 024WB, 025, 025AVH, 025C	0,5	PR15Y	CLASSIC	PR17YC	SUPER
025 Wood Boss, 026, 026AVP, 026 Artic, 026C	0,5	PR15Y	CLASSIC	PR17YC	SUPER
026 Pro, 026S	0,5	PR15Y	CLASSIC	PR17YC	SUPER
028, 028AV, 028AVE, 028AVS, 028S, 028WB	0,5	PR15Y	CLASSIC	PR17YC	SUPER
029, 029 Farm Boss, 029S	0,5	PR15Y	CLASSIC	PR17YC	SUPER
030, 030AV, 031, 031AV, 031AVEQ	0,5	PR15Y	CLASSIC	PR17YC	SUPER
032, 032AV, 032AVE, 034, 034AV, 034AVEQ, 034WB	0,5	PR15Y	CLASSIC	PR17YC	SUPER
036, 036AV, 036 Pro, 036 Pro Artic, 036QS, 036W	0,5	PR15Y	CLASSIC	PR17YC	SUPER
038, 038AV, 038AVE, 038AVMEQ, 038AVS	0,5	PR15Y	CLASSIC	PR17YC	SUPER
038 Magnum, 039	0,5	PR15Y	CLASSIC	PR17YC	SUPER
040, 040AV, 040G (Light Service)	0,5	PR17Y	CLASSIC	PR17YC	SUPER
040, 040G (Normal Service)	0,5	PR15Y	CLASSIC	PR17YC	SUPER
040, 040G (Severe Service)	0,5	PR15	CLASSIC		
040, 040S (Heavy Service)	0,5	PR15	CLASSIC		
041, 041AV, 041AVE, 041AVE Super, 041FB	0,5	PR15Y	CLASSIC	PR17YC	SUPER
042, 042AV, 042AVE, 042AVEQ	0,5	PR15Y	CLASSIC	PR17YC	SUPER
044, 044 Artic, 044AVE, 044C, 044 Cat, 044CSA	0,5	PR15Y	CLASSIC	PR17YC	SUPER
044W, 045, 045AV, 045AVE, 045AVE Super	0,5	PR15Y	CLASSIC	PR17YC	SUPER
046, 046 Artic, 046C, 046 Magnum, 046RHD	0,5	PR15Y	CLASSIC	PR17YC	SUPER
048, 048AV, 048AVE, 050, 050AV	0,5	PR15Y	CLASSIC	PR17YC	SUPER
051, 051AV, 051AVE, 055	0,5	PR15Y	CLASSIC	PR17YC	SUPER
056, 056AV, 056AVE, 056AVS	0,5	PR15Y	CLASSIC	PR17YC	SUPER
064, 064AVEP, 064AVEQ, 064AVREQ, 064W, 065	0,5	PR15Y	CLASSIC	PR17YC	SUPER
066, 066 Magnum, 066W	0,5	PR15Y	CLASSIC	PR17YC	SUPER
070, 070AV, 071, 075, 075AV, 075AVE	0,5	PR15Y	CLASSIC	PR17YC	SUPER
076, 076AV, 078AVE, 084, 084AV, 084AVEQ, 084Z	0,5	PR15Y	CLASSIC	PR17YC	SUPER
088, 090, 090AV, 090E, 090G, 090N, 090R, 090S	0,5	PR15Y	CLASSIC	PR17YC	SUPER
1106-Contra, 1601	0,5	PR15Y	CLASSIC	PR17YC	SUPER
BG 60E	0,5	PR17	CLASSIC		
H 151	0,5	PR15Y	CLASSIC	PR17YC	SUPER
HL 45, HL 75, HL 75L	0,5	PR15Y	CLASSIC	PR17YC	SUPER
HL 100, HL 100K		TR15C	SUPER		
HLR 85	0,5	PR15Y	CLASSIC	PR17YC	SUPER
HS 45, HS 60, HS 61, HS 72, HS 74, HS 75, HS 76	0,5	PR15Y	CLASSIC	PR17YC	SUPER
HS 80, HS 85	0,5	PR15Y	CLASSIC	PR17YC	SUPER
HS 81R, HS 81T, HS 86R, HS 86T		TR15C	SUPER		
HS 151, HS 202, HS 242, HS 246	0,5	PR15Y	CLASSIC	PR17YC	SUPER
KS 43		L15C ^{+R}	SUPER		
MS 170, MS 180, MS 180BE, MS 180C	0,5	PR15Y	CLASSIC	PR17YC	SUPER
MS 190T, MS 191T, MS 192T, MS 200, MS 200T	0,5	PR15Y	CLASSIC	PR17YC	SUPER
MS 210, MS 210C, MS 230, MS 230C	0,5	PR15Y	CLASSIC	PR17YC	SUPER
MS 240, MS 250, MS 250C, MS 260	0,5	PR15Y	CLASSIC	PR17YC	SUPER
MS 270, MS 270C, MS 280, MS 280C	0,5	PR15Y	CLASSIC	PR17YC	SUPER
MS 290, MS 310, MS 341, MS 361	0,5	PR15Y	CLASSIC	PR17YC	SUPER
MS 361C, MS 361W, MS 390, MS 440	0,5	PR15Y	CLASSIC	PR17YC	SUPER
MS 460, MS 650, MS 660, MS 880	0,5	PR15Y	CLASSIC	PR17YC	SUPER
S10	0,5	PR15Y	CLASSIC	PR17YC	SUPER



STIHL

MOTOROVÉ PILY • CHAINSAW • МОТОПИЛЫ

TS 08 (- X18 735 398)	0,5	NR17C	SUPER		
TS 08 (X18 735 399 -)	0,5	PR15Y	CLASSIC	PR17YC	SUPER
TS 50, TS 200	0,5	PR15Y	CLASSIC	PR17YC	SUPER
TS 350 (- X17 451 127)	0,5	NR17C	SUPER		
TS 350 (X17 451 128 -)	0,5	PR15Y	CLASSIC	PR17YC	SUPER
TS 350AVE, TS 350S, TS 360AVE, TS 360S	0,5	PR15Y	CLASSIC	PR17YC	SUPER
TS 400, TS 460, TS 480, TS 510, TS 510AVE	0,5	PR15Y	CLASSIC	PR17YC	SUPER
TS 700, TS 760, TS 760AVE	0,5	PR15Y	CLASSIC	PR17YC	SUPER

MOTOROVÉ TRAVNÍ SEKAČKY • LAWN MOWER • СЕНОКОСИЛКИ

BA 20	0,5	K17C	SUPER		
BB 800	0,5	PR17	CLASSIC		
CB 700	0,5	PR17	CLASSIC		
Park 20008, Privat 8E, President, Pony 6, Pony 8	0,5	PR17	CLASSIC		
RA Dino (2Takt)	0,5	K17C	SUPER		
RB Dino (4Takt)	0,5	PR17	CLASSIC		
SB 50 Vario-speed	0,5	PR17	CLASSIC		
Tornado TB 300, Tornado TB 500	0,5	PR17	CLASSIC		
Viking MB 400, Viking MB 455		JR19	CLASSIC		
Viking MB 505, Viking MB 486B		JR19	CLASSIC		

SUPA - PRAKTIS

KULTIVÁTORY • CULTIVATORS • КУЛЬТИВАТОРЫ

Honda GCV 160		LR15YC	SUPER	LR15YS	SILVER
Honda GCV 190		LR15YC	SUPER	LR15YS	SILVER

SUZUKI

ELEKTROCENTRÁLY / STACIONÁRNÍ MOTORY • ELEKTROCENTRALS / STATIONARY ENGINES • ЭЛЕКТРИЧЕСКИЕ КОММУТАТОРЫ / СТАЦИОНАРНЫЕ ДВИГАТЕЛИ

SE 400, SE 400A, SE 400C, SE 400T		PR18Y	CLASSIC		
SE 500, SE 500A, SE 500C		PR18Y	CLASSIC		
SE 600		PR18Y	CLASSIC		
SE 700, SE 700A		PR18Y	CLASSIC		
SE 800		PR18Y	CLASSIC		
SE 1000		NR15YC	SUPER		
SE 1200, SE 1200A, SE 1200L		NR15YC	SUPER		
SE 1200LA, SE 1500		NR15YC	SUPER		
SE 1800, SE 1800A, SE 1800K		LR15YC	SUPER	LR15YS	SILVER
SE 1800KL, SE 1800L, SE 1800LA		LR15YC	SUPER	LR15YS	SILVER
SE 2500, SE 2500A, SE 2500K		NR15YC	SUPER		
SE 3000, SE 3000A		NR15YC	SUPER		
SV 1400, SV 2200		LR15YC	SUPER	LR15YS	SILVER
SV 4000		LR17YC	SUPER	LR17YS	SILVER
SVW 140		LR17YC	SUPER	LR17YS	SILVER
V 270		NR15YC	SUPER		
VM 140		PR18Y	CLASSIC		

TANAKA

ELEKTROCENTRÁLY / STACIONÁRNÍ MOTORY • ELEKTROCENTRALS / STATIONARY ENGINES • ЭЛЕКТРИЧЕСКИЕ КОММУТАТОРЫ / СТАЦИОНАРНЫЕ ДВИГАТЕЛИ

DEG 600		K17C	SUPER		
LEG 1200		K17C	SUPER		
QEG 250, QEG 300		P17	CLASSIC		
REG 80		K17C	SUPER		
REG 800, REG 1000		K15YC	SUPER		
SEG 100		K17C	SUPER		
SEG 221	0,6	N15C	SUPER	NR15S	SILVER

TECUMSEH

ELEKTROCENTRÁLY / STACIONÁRNÍ MOTORY • ELEKTROCENTRALS / STATIONARY ENGINES • ЭЛЕКТРИЧЕСКИЕ КОММУТАТОРЫ / СТАЦИОНАРНЫЕ ДВИГАТЕЛИ

AH 480, AH 817		K19	CLASSIC		
AH 520		K17Y	CLASSIC		
AH 600		P17Y	CLASSIC	PR17YC	SUPER



service
instructions

... BOSCH ...
... CHAMPION ...
... NGK ...



BRISK

LAST INFO

**STANDARD
BRISK**
**ALTERNATIVE
BRISK**
TECUMSEH
ELEKTROCENTRÁLY / STACIONÁRNÍ MOTORY • ELEKTROCENTRALS / STATIONARY ENGINES • ЭЛЕКТРИЧЕСКИЕ КОММУТАТОРЫ / СТАЦИОНАРНЫЕ ДВИГАТЕЛИ

AV 520 (3 HP)	J19	CLASSIC		
AV 600 (3,8 HP)	K19	CLASSIC		
AV 600 (5 HP)	J17	CLASSIC		
H 25, H 30, H 35, H 50, H 60, H 70, H 80	K19	CLASSIC		
HH 40, HH 50, HH 60, HH 70, HH 80, HH 100	K19	CLASSIC		
HMM 80	K19	CLASSIC		
HM 70, HM 80, HM 100	K19	CLASSIC		
HS 40, HS 50	K19	CLASSIC		
HSK 300	P17Y	CLASSIC	PR17YC	SUPER
HXL 35	K19	CLASSIC		
LAV 30, LAV 35, LAV 40, LAV 50	K19	CLASSIC		
OVRM 40	L15C	SUPER	LR15S	SILVER
TCH 200	P17Y	CLASSIC	PR17YC	SUPER
TCH 300	P15Y	CLASSIC	PR17YC	SUPER
TNT 100	J19	CLASSIC		
TVM 125, TVM 140, TVM 170, TVM 195, TVM 220	K19	CLASSIC		
TVS 75	J19	CLASSIC		
TVS 90, TVS 100, TVS 105, TVS 120	J19	CLASSIC		
TVS 520 (2,75 HP)	J17	CLASSIC		
TVS 600	J17	CLASSIC		
TVS 840	P17Y	CLASSIC	PR17YC	SUPER
TVXL 105	J19	CLASSIC		
TVXL 170, TVXL 195, TVXL 220	K19	CLASSIC		
TVXL 840	P17Y	CLASSIC	PR17YC	SUPER
V 50, V 60, V 80	K19	CLASSIC		
VH 40, VH 50, VH 60, VH 100	K19	CLASSIC		
VM 80, VM 100	K19	CLASSIC		

TONDU
KŘOVINOŘEZY • BRUSH CUTTERS • ТРИММЕРЫ

16 ccm, 22 ccm	0,5	P15	CLASSIC		
35 ccm	0,5	P17	CLASSIC		

MOTOROVÉ PÍLY • CHAINSAW • МОТОПИЛЫ

30F, 35F, 42F		PR17Y	CLASSIC	PR17YC	SUPER
---------------	--	-------	---------	--------	-------

TORO
KŘOVINOŘEZY • BRUSH CUTTERS • ТРИММЕРЫ

51 930 (USA), 51 932 (USA), 51 934 (USA)		SR14C	CLASSIC		
--	--	-------	---------	--	--

MALOTRAKTORY • TRACTORS • МАЛОГАБАРИТНЫЕ ТРАКТОРЫ

468 (B & S)	0,5	J19	CLASSIC		
-------------	-----	-----	---------	--	--

MOTOROVÉ TRAVNÍ SEKAČKY • LAWN MOWER • СЕНОКОСИЛКИ

B 48G (ONAN)		GR17YC	SUPER	GR17YS	SILVER
B & S		J19	CLASSIC		
K 141, K 181 (Kohler)	0,8	K19	CLASSIC		
Kioritz	0,8	P17	CLASSIC		
R 839 (Teledyne)		N14YC	SUPER		
Tecumseh		J17	CLASSIC		

TROMECA
KŘOVINOŘEZY • BRUSH CUTTERS • ТРИММЕРЫ

200, 260, 260D, 400A, 460AVS	0,5	PR17Y	CLASSIC	PR17YC	SUPER
8420, 8510, 8515	0,5	PR17Y	CLASSIC	PR17YC	SUPER

MOTOROVÉ PÍLY • CHAINSAW • МОТОПИЛЫ

935DF, 942, 946, 951, 999F	0,5	PR17Y	CLASSIC	PR17YC	SUPER
----------------------------	-----	-------	---------	--------	-------

MOTOROVÉ TRAVNÍ SEKAČKY • LAWN MOWER • СЕНОКОСИЛКИ

20805, 20905		JR19	CLASSIC		
AS 21A8, AS 21A81 / (4,5 HP)		N17C	SUPER		
AS 21BS		JR19	CLASSIC		
AS 22F, AS 27A82, AS 27A92 / (7 HP)		N17C	SUPER		



TROMECA

MOTOROVÉ TRAVNÍ SEKAČKY • LAWN MOWER • СЕНОКОСИЛКИ

AS 53B1, AS 53B1R	N17C	SUPER		
AS 21165, AS 26A82, AS 26A92 / (7 HP)	N17C	SUPER		
LM 21SP2S (SB152 - F & S)	N17C	SUPER		
LM 21SP2K (FC180V - Kawasaki)	LR15YC	SUPER	LR15YS	SILVER
Montana BQ 5	JR19	CLASSIC		
Rider / K12 (I / C 11,5-12,5)	JR19	CLASSIC		
Senator 10, Senator 12, Senator 1238, Senator 13, Senator 13H	JR19	CLASSIC		
TR 346P	JR17	CLASSIC		
TR 4431BS	JR19	CLASSIC		
TRT 443, TR 500T	JR19	CLASSIC		
TRT 4431BS, TRT 4481BQ, TRT 4481BQD	JR19	CLASSIC		
TRT 4481K (FC150)	LR15YC	SUPER	LR15YS	SILVER
TRT 5471BQ, TRT 5471 BQD	JR19	CLASSIC		
TRT 5531BQ, TRT 5531 BQD	JR19	CLASSIC		

TROMECA-EFCO

KŘOVINOŘEZY • BRUSH CUTTERS • ТРИММЕРЫ

TE 22F, TE 22R, TE 26, TE 30	PR17Y	CLASSIC	PR17YC	SUPER
TE 40, TE 40GT, TE 41	PR17Y	CLASSIC	PR17YC	SUPER

VALPADANA

MALOTRAKTORY • TRACTORS • МАЛОГАБАРИТНЫЕ ТРАКТОРЫ

1400K, 2000K, 2800K	0,6	N17YC	SUPER		
2000, 2000DV, 2400 (-08.84)	0,6	N15YC	SUPER		
2000, 2000DV, 2400 (09.84-)	0,6	NR15YC	SUPER		
2800, 2800DV (-08.84)	0,6	N15YC	SUPER		
2800, 2800DV (09.84-)	0,6	NR15YC	SUPER		
EF 1200, EF 1400, EF 1400DV (-08.84)	0,6	N15YC	SUPER		
EF 1200, EF 1400, EF 1400DV (09.84-)	0,6	NR15YC	SUPER		
ET 1500	0,6	N14C	SUPER	NR14S	SILVER
VMC 14, VMC 130 (IM350), VMC 150	0,6	N19C	SUPER		
VMC 130 (AL330)	0,5	N17C	SUPER		

VAP

KŘOVINOŘEZY • BRUSH CUTTERS • ТРИММЕРЫ

CBT 45	0,5	PR17Y	CLASSIC	PR17YC	SUPER
DB 23, DB 24, DB 28, DB 33, DB 47, DB 49	0,5	PR17Y	CLASSIC	PR17YC	SUPER

MOTOROVÉ PÍLY • CHAINSAW • МОТОПИЛЫ

530, 535, 542, 548, 553, 570	0,5	PR17Y	CLASSIC	PR17YC	SUPER
------------------------------	-----	-------	---------	--------	-------

MOTOROVÉ TRAVNÍ SEKAČKY • LAWN MOWER • СЕНОКОСИЛКИ

1081E, 1281E, 1296E	JR19	CLASSIC		
13105 Hydro, 14106 Hydro	JR19	CLASSIC		
14105	DR17YC	SUPER	DR17YS	SILVER
Border F4, Border F4A	JR17	CLASSIC		
Boxer - all models	JR17	CLASSIC		
Pointer F4.37, Pointer F4.46 T37	JR17	CLASSIC		
Springer B5A, Springer F5A, Springer F5AE	JR19	CLASSIC		
Springer K5A	LR15YC	SUPER	LR15YS	SILVER

VARI

KULTIVÁTORY • CULTIVATORS • КУЛЬТИВАТОРЫ

F-530 (Honda GCV 160 - 5,5 HP)	LR15YC	SUPER	LR15YS	SILVER
F-600 (Honda GCV 190 - 6,5 HP)	LR15YC	SUPER	LR15YS	SILVER
F-700 (Honda GXV 340 - 9,0 HP)	LR17YC	SUPER	LR17YS	SILVER

MOTOROVÉ TRAVNÍ SEKAČKY • LAWN MOWER • СЕНОКОСИЛКИ

BDR-595 ADELA 60 (Honda GCV 160 - 5,5 HP)	LR15YC	SUPER	LR15YS	SILVER
BDR-595E EUROADELA (Honda GCV 160 - 5,5 HP)	LR15YC	SUPER	LR15YS	SILVER
BDR-620 LUCINA 65 (Honda GCV 190 - 6,5 HP)	LR15YC	SUPER	LR15YS	SILVER
BDR-1200 (Honda GXV 390 - 13 HP)	LR17YC	SUPER	LR17YS	SILVER
DS-521 LIZA 60 (Honda GCV 160 - 5,5 HP)	LR15YC	SUPER	LR15YS	SILVER



service
instructions

... BOSCH ...
... CHAMPION ...
... NGK ...



cross reference



LAST INFO



**STANDARD
BRISK**

**ALTERNATIVE
BRISK**

VARI

MOTOROVÉ TRAVNÍ SEKAČKY • LAWN MOWER • СЕНОКОСИЛКИ

GXV 120 (4 HP), GXV 160 (5,5 HP)	LR17YC	SUPER	LR17YS	SILVER
Timan RC-750 (Honda iGX 440 - 15 HP)	DR15YC	SUPER	DR15YS	SILVER

WARDS

MOTOROVÉ PÍLY • CHAINSAW • МОТОПИЛЫ

24000A, 24001A, 24002A	P15	CLASSIC		
24002B, 24002C, 24003A	P15	CLASSIC		
24005A, 24005B, 24006A	P15	CLASSIC		
24006B, 24007A, 24007B	P15	CLASSIC		
24008A, 24008B, 24025A	P15	CLASSIC		
24025B, 24027A, 24028A	P15	CLASSIC		
24030A, 24031A, 24033A	P15	CLASSIC		
24032A, 24034A, 24035A	P15	CLASSIC		
24036A, 24036B, 24036C, 24036D	P15	CLASSIC		
24037A, 24038A, 24040A	P15	CLASSIC		
24040B, 24040C, 24045A	P15	CLASSIC		
24050A, 24052A, 24062	P17Y	CLASSIC	PR17YC	SUPER
24054A, 24056A, 24064	P17Y	CLASSIC	PR17YC	SUPER
24066, 24068, 24078	P17Y	CLASSIC	PR17YC	SUPER
24084, 24086	P17Y	CLASSIC	PR17YC	SUPER
2407-8	K15YC	SUPER		
24075C, 24085A, 24095A	P15	CLASSIC		
24087A, 24089A, 24090A	P15	CLASSIC		
24094A, 24096A, 30000A	P15	CLASSIC		
24102-9, 24100-1, 24103-6	P17	CLASSIC		
24148	K19	CLASSIC		
30004A, 30008A, 30012A	P15	CLASSIC		
30016A, 30020A, 30024A	P15	CLASSIC		
TMC 24060A	K17C	SUPER		
TMC 24072A, TMC 24075A, TMC 24075B	P15	CLASSIC		

YAMAHA

ELEKTROCENTRÁLY / STACIONÁRNÍ MOTORY • ELEKTROCENTRALS / STATIONARY ENGINES • ЭЛЕКТРИЧЕСКИЕ КОММУТАТОРЫ / СТАЦИОНАРНЫЕ ДВИГАТЕЛИ

EF 600		PR18Y	CLASSIC		
EF 1000, EF 1000 B, EF 1200, EF 1200DV	0,6	NR15YC	SUPER		
EF 1400, EF 1400A, EF 1400DV	0,6	NR15YC	SUPER		
EF 1400X		LR17YC	SUPER	LR17YS	SILVER
EF 1400K	0,6	NR17YC	SUPER		
EF 1500S		N14C	SUPER	NR14S	SILVER
EF 1600, EF 1700, EF 1700A, EF 1700DV		NR15YC	SUPER		
EF 1800		N15YC	SUPER		
EF 2000, EF 2000DV (-1984)		N15YC	SUPER		
EF 2000, EF 2000A, EF 2000DV (1985-)		NR15YC	SUPER		
EF 2000H		N15YC	SUPER		
EF 2000HK		N17YC	SUPER		
EF 2000K (-1984)		N17YC	SUPER		
EF 2000K (1985-)		NR17YC	SUPER		
EF 2100		NR15YC	SUPER		
EF 2300A, EF 2300X		LR17YC	SUPER	LR17YS	SILVER
EF 2400 (-1984)		N15YC	SUPER		
EF 2400A, EF 2400DV		NR15YC	SUPER		
EF 2500, EF 2500R (2100R)		NR15YC	SUPER		
EF 2600		N15YC	SUPER		
EF 2800, EF 2800DV (-1984)		N15YC	SUPER		
EF 2800, EF 2800DV (1985-)		NR15YC	SUPER		
EF 2800A		NR15YC	SUPER		
EF 2800H	0,6	N15YC	SUPER		
EF 2800HK		N17YC	SUPER		



STANDARD
BRISK

ALTERNATIVE
BRISK

YAMAHA

ELEKTROCENTRÁLY / STACIONÁRNÍ MOTORY • ELEKTROCENTRALS / STATIONARY ENGINES • ЭЛЕКТРИЧЕСКИЕ КОММУТАТОРЫ / СТАЦИОНАРНЫЕ ДВИГАТЕЛИ

EF 2800K (-1984)		N17YC	SUPER		
EF 2800K (1985-)		NR17YC	SUPER		
EF 3200, EF 3800		NR15YC	SUPER		
EF 3200 E	0,6	NR15YC	SUPER		
EF 3600 (E), EF3600DV (E)		NR15YC	SUPER		
EF 3800R (3200R)		NR15YC	SUPER		
EF 4000, EF 4000DV, EF 4000E		NR15YC	SUPER		
EF 4000A, EF 4000 EX		LR17YC	SUPER	LR17YS	SILVER
EF 4000X		LR17YC	SUPER	LR17YS	SILVER
EF 4000K		NR17YC	SUPER		
EF 4300		NR15YC	SUPER		
EF 4400		NR15YC	SUPER		
EF 4400 (E), EF 4400DV (E)		NR15YC	SUPER		
EF 5000		LR17YC	SUPER	LR17YS	SILVER
EF 5000 (E), EF 5000DV (E)		NR15YC	SUPER		
EF 5400, EF 5400E		LR17YC	SUPER	LR17YS	SILVER
EF 5500A, EF 5500EX, EF 5500X, EF 6000		LR17YC	SUPER	LR17YS	SILVER
EFC 1400, EFC 2000, EFC 2600, EFC 2800		N15YC	SUPER		
ET 350, ET 500, ET 600 (A)		L17C	SUPER		
ET 800, ET 900 (A)		L17C	SUPER		
ET 1500 (-1980)		N15C	SUPER	NR15S	SILVER
ET 1500 (1981-)		N14C	SUPER	NR14S	SILVER
ET 1500D, ET 1500M, ET 1500S		N14C	SUPER	NR14S	SILVER
MF 150A, MF 150S	0,6	N15YC	SUPER		
MF 180A, MF 180AR, MF 180S, MF 180SR	0,6	N15YC	SUPER		
MF 180AK, MF 180K, MF 180SK	0,6	N17YC	SUPER		
MF 260A, MF 260AR, MF 260S, MF 260SR	0,6	N15YC	SUPER		
MF 260AK, MF 260K, MF 260SK	0,6	N17YC	SUPER		
MF 410, MF 410S, MF 410SR	0,6	N15YC	SUPER		
MF 410SK	0,6	N17YC	SUPER		
MT 110A, MT 110AR	0,6	N14C	SUPER	NR14S	SILVER
MT 110VL	0,6	N14C	SUPER	NR14S	SILVER
YG 300S, YG 400D		NR15YC	SUPER		
YG 500D, YG 600D		LR17YC	SUPER	LR17YS	SILVER
YP 2	0,6	N14C	SUPER	NR14S	SILVER
YP 3	0,6	N15YC	SUPER		
YP 10, YP 10G		NR14C	SUPER	NR14S	SILVER
YP 15H	0,6	N15YC	SUPER		
YP 20	0,6	N17YC	SUPER		
YP 20G (N)	0,9	N17YC	SUPER		
YP 20G	0,6	N14C	SUPER	NR14S	SILVER
YP 20GA		NR15YC	SUPER		
YP 20GN		N17YC	SUPER		
YP 20H, YP 20M, YP 20MH, YP 20S, YP 20Z	0,6	N15YC	SUPER		
YP 20NT	0,6	N15YC	SUPER		
YP 20S		N15YC	SUPER		
YP 20TA		NR15YC	SUPER		
YP 30	0,6	L17YC	SUPER	LR17YS	SILVER
YP 30E	0,6	N17YC	SUPER		
YP 30G	0,6	N15YC	SUPER		
YP 30GA		NR15YC	SUPER		
YP 30GK	0,6	N17YC	SUPER		
YP 30GN (-1987)		N15YC	SUPER		
YP 30GN (1988-1990)		L17YC	SUPER	LR17YS	SILVER
YP 30MH		N15YC	SUPER		
YP 30NT, YP 30S, YP 30T	0,6	N15YC	SUPER		



service
instructions

... BOSCH ...
... CHAMPION ...
... NGK ...



BRISK

LAST INFO



STANDARD
BRISK

ALTERNATIVE
BRISK

YAMAHA

ELEKTROCENTRÁLY / STACIONÁRNÍ MOTORY • ELEKTROCENTRALS / STATIONARY ENGINES • ЭЛЕКТРИЧЕСКИЕ КОММУТАТОРЫ / СТАЦИОНАРНЫЕ ДВИГАТЕЛИ

YP 30TA, YP 40TA

NR15YC SUPER

YANMAR

ELEKTROCENTRÁLY / STACIONÁRNÍ MOTORY • ELEKTROCENTRALS / STATIONARY ENGINES • ЭЛЕКТРИЧЕСКИЕ КОММУТАТОРЫ / СТАЦИОНАРНЫЕ ДВИГАТЕЛИ

3TG 66, 3TG 72

LR17YC SUPER LR17YS SILVER

GA 90, GA 120, GA 140, GA 160

LR17YC-9 SUPER LR17YS-9 SILVER

GA 180, GA 210, GA 220, GA 240

LR17YC-9 SUPER LR17YS-9 SILVER

GA 280, GA 300

LR17YC-9 SUPER LR17YS-9 SILVER

GE 20

PR18Y CLASSIC

GE 50, GE 55, GE 70, GE 77, GE 90

0,6 NR17YC SUPER

GY 15, GY 20

PR18Y CLASSIC

GY 35

NR17YC SUPER

GY 35 (V), GY 50 (V)

N19C SUPER

YSG 550E

PR18Y CLASSIC

YSG 750A, YSG 750AE, YSG 750E

PR18Y CLASSIC

YSG 1505, YSG 2005, YSG 2505

LR17YC-9 SUPER LR17YS-9 SILVER

YSG 1506, YSG 2006, YSG 2506

LR17YC-9 SUPER LR17YS-9 SILVER

YSG 3005, YSG 3505

LR17YC-9 SUPER LR17YS-9 SILVER

YSG 3006, YSG 3506

LR17YC-9 SUPER LR17YS-9 SILVER

HP ↔ kW



INFO

HP	kW
1	0,736
30	22
35	26
40	29
45	33
50	37
55	40
60	44
65	48
70	51
75	55
80	59
85	63
90	66
95	70
100	74
105	77
110	81
115	85
120	88
125	92
130	96
135	99
140	103
145	107
150	110
155	114
160	118
165	121
170	125
175	129
180	132
185	136
190	140
195	143
200	147
205	151
210	154
215	158
220	162
225	165
230	169
235	173
240	177
245	180
250	184
255	188
260	191
265	195
270	199
275	202

kW	HP
1	1,360
20	27
25	34
30	41
35	48
40	55
45	61
50	68
55	75
60	82
65	88
70	95
75	102
80	109
85	115
90	122
95	129
100	136
105	143
110	150
115	156
120	163
125	170
130	177
135	184
140	190
145	197
150	204
155	211
160	218
165	225
170	231
175	238
180	245
185	252
190	258
195	265
200	272
205	279
210	286
215	292
220	299
225	306
230	313
235	320
240	326
245	333
250	340
255	347
260	354
265	360

+R

OBJEDNACÍ ČÍSLO / ORDER №
/ ЗАКАЗАТЬ НОМЕР (CODE)

1814

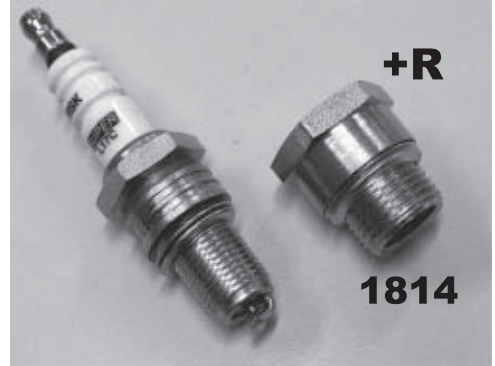

Proper installation of spark plugs

Správná montáž zapalovacích svíček

Правильный способ установки свечей зажигания

Before installation make you always sure that you use the proper type of the spark plug for particular engine.

Před montáží zkontrolujte, zda používáte správný typ zapalovací svíčky do daného typu motoru.

Прежде чем установить свечу зажигания, всегда убедитесь в том, что тип свечи подходит для данного типа двигателя.



Check out before installation whether the spark plug is provided with external gasket and whether the external gasket did not stay in the cylinder head from the preceding spark plug after repeated installation (this is not valid for taper seat spark plug).

Před montáží zkontrolujte, zda je zapalovací svíčka opatřena těsnící podložkou a zda v hlavě válce při opětovné montáži nezůstala těsnící podložka z předchozí zapal. svíčky (neplatí pro svíčky těsněné kuželem).

Перед началом работы необходимо проверить, имеет ли свеча зажигания уплотнительную шайбу и не осталась ли в отверстии головки цилиндра уплотнительная шайба предыдущей свечи (это не относится к свечам с конической посадкой).



SPARK PLUG / ZAPALOVACÍ SVÍČKA / СВЕЧА ЗАЖИГАНИЯ		HEAD OF ENGINE / HLAVA MOTORU / ГОЛОВА ДВИГАТЕЛЯ	
THREAD / ZÁVIT / РЕЗЬБА		Fe	Al
M 10 x 1		10 - 15 Nm	10 - 15 Nm
M 12 x 1,25		15 - 20 Nm	15 - 20 Nm
M 14 x 1,25		20 - 40 Nm	20 - 30 Nm
M 14 x 1,25		10 - 20 Nm	10 - 20 Nm
M 18 x 1,5		20 - 30 Nm	20 - 30 Nm

Tightening torque must be within tolerancies gives in the table above.

Utahovací moment musí být v tolerancích daných výše uvedenou tabulkou.

Усилие затяжки не должно превышать значение, указанное в таблице.

At spark plug installation into and removing from cylinder head it is not allowed to apply force on the insulator.

Při montáži a demontáži zapalovací svíčky do hlavy válce nesmí být působeno na izolátor silou.

В ходе снятия старой и установки новой свечи в головку цилиндра не прикладывать усилие на керамический изолятор свечи.

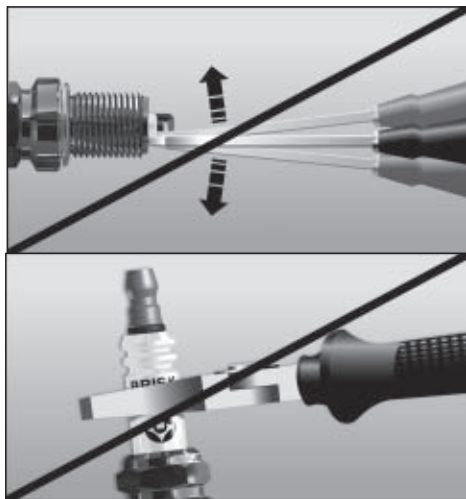

Use always the proper spark plug wrench which is not too loose and is provided with centring ring from soft material.

Používejte vždy správný klíč na svíčky, který není příliš volný a je opatřen středícím mezikroužkem z měkkého materiálu.

Всегда применяйте подходящий ключ для свечей, который не слишком большой и имеет промежуточное центрирующее кольцо из мягкого материала.

Tightening torque must be applied perpendicular to the spark plug axis.

Utahovací moment musí působit kolmo na osu zapalovací svíčky.

Усилие затяжки следует прикладывать перпендикулярно к оси свечи зажигания.

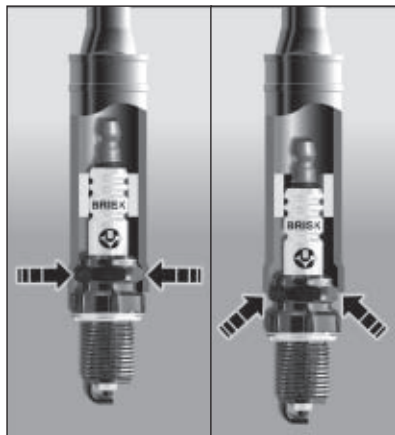

Tightening torque can be applied in such case only when the wrench is put on across the whole length of hexagon of spark plug metall shell.

Utahovacím momentem lze působit jen v případě, že klíč je nasazen přes celou délku šestihranu pouzdra svíčky.

Свечу можно затянуть только тогда, если ключ правильно установлен на шестиграннике со всех сторон.

As long as at the installation of spark plug it comes to tightening torque overrun by 50% than the spark plug is not allowed to use any more.

Pokud dojde při demontáži zapalovací svíčky z motoru k překročení utahovacího momentu o 50%, nesmí být zapalovací svíčka dále použita.

Если в ходе снятия свечи зажигания с двигателя было превышено усилие затяжки на более чем 50%, дальнейшее употребление такой свечи не разрешается.

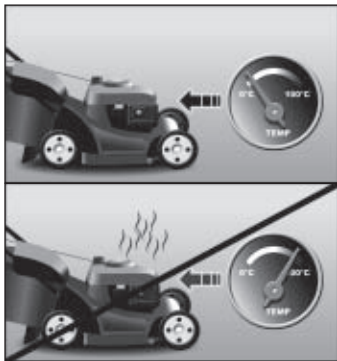
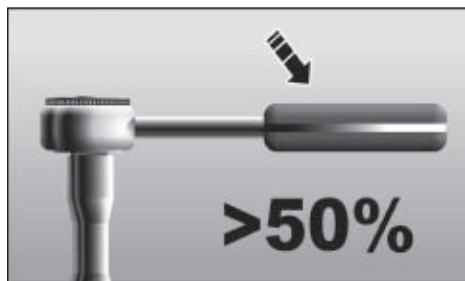

Spark plug installation and removing from the cylinder head must be carried out only when the engine has ambient temperature. Removing and installing spark plug while hot can actually cause thread and cylinder head damage.

Montáž a demontáž provádějte v době, kdy hlava válce má teplotu okolí. Při demontáži nebo montáži do horké hlavy válců může dojít k poškození hlavy válců nebo zapalovací svíčky.

Снятие и установку новой свечи на двигатель следует выполнять после охлаждения головки цилиндров до температуры окружающей среды. Снятие и установка свечи в горячую головку цилиндров может повредить головку или свечу зажигания.

After spark plug installation check out whether the cable boot are proper fixed to the spark plug.

Po montáži překontrolujeme, zda jsou kabelové koncovky dokonale zafixovány k zapalovací svíčce.

После окончания работы следует проверить прочное закрепление наконечника кабеля на свече зажигания.



Spark plugs do not require any maintenance during the replacement interval. Certain level of maintenance is, however, required by the vehicle whose part the spark plugs are. All deficiencies caused by an insufficient vehicle maintenance can be reflected on the spark plug. That is why we recommend, within the framework of prevention, to check the spark plugs at least once a year. Their appearance reflects technical conditions of your vehicle.

Spark plugs replacement intervals are specified for a maximum mileage performance of the engine in a good technical condition. Therefore never exceed the replacement intervals prescribed for a given type of spark plugs! Possible spark plug replacement before the interval prescribed will not cause any problem.

Zapalovací svíčky v průběhu intervalu výměny nevyžadují žádnou údržbu. Údržbu však vyžaduje vozidlo, jehož součástí zapalovací svíčky jsou. Na zapalovací svíčce se promítají všechny nedostatky, které jsou způsobeny nedostatečnou údržbou vozidla. Proto doporučujeme v rámci prevence překontrolovat alespoň jedenkrát ročně zapalovací svíčky. Jejich vzhled vypovídá o technickém stavu vozidla.

Intervaly výměny zapalovacích svíček jsou stanoveny pro maximální kilometrový průběh motoru v dobrém technickém stavu. Proto předepsané intervaly výměny pro daný typ zapalovacích svíček nepřekračujte! Výměna zapalovacích svíček před stanoveným intervalem není na závadu.

Свечи зажигания в течение интервала между заменами не требуют никакого технического обслуживания. Однако техническое обслуживание необходимо для транспортного средства, составными частями которого свечи зажигания являются. На свече зажигания проявляются все недостатки, которые появляются из-за недостаточного технического обслуживания транспортного средства. Поэтому в рамках предупреждения таковых рекомендуется хотя бы один раз в год проверить свечи зажигания. Их вид говорит о техническом состоянии вашего транспортного средства.

Интервалы замены свечей зажигания определены для максимального километрового пробега мотора в хорошем техническом состоянии. Поэтому не превышайте предписанные интервалы замены для данного типа свечей зажигания! Замена свечей зажигания до установленного истечения интервала не наносит вреда.

Procedure to modify the electrode spacing of BRISK spark plugs

Úprava elektrodové vzdálenosti u zapalovacích svíček BRISK

Порядок действий при регулировке искрового зазора свечей зажигания БРИСК

Using screwdriver (this operation requires a certain skill). Insert the screwdriver between external and central electrode in the axle of external electrode the way the screwdriver touched only external electrode. Lever the external electrode by several tenths of millimetre over the back of thumb.

Pomocí šroubováku (tato operace vyžaduje určitou zručnost). Šroubovák vložíme mezi vnější a střední elektrodu v ose vnější elektrody tak, aby se šroubovák dotýkal pouze vnější elektrody. Přes hřbet palce povelíme vnější elektrodu o několik desetin milimetru.

При помощи отвертки (данная операция требует определенного опыта). Вставьте отвертку между боковой и центральной электроды по оси бокового электрода таким образом, чтобы отвертка касалась только бокового электрода. Опираясь на большой палец руки, отогните боковой электрод на несколько десятых миллиметра.

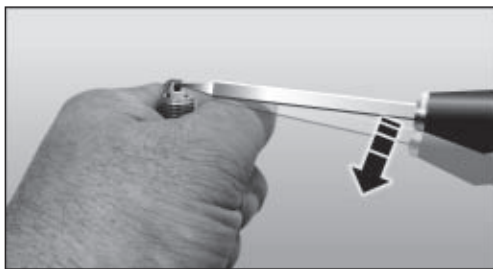

Important rules / Důležité zásady / Важные принципы





WARNING !!!

This cross reference table is informative only.

Due to differences in design and materials the spark plugs of various manufacturers do not have exactly the same heat range.

See the recommendations in application tables of this catalogue to select a right spark plug.

UPOZORNĚNÍ !!!

Tato srovnávací tabulka je pouze informativní.

Zapalovací svíčky od různých výrobců nemají z důvodu rozdílné konstrukce a použitým materiálům zcela srovnatelné hodnoty.

Pro správný výběr zapalovací svíčky je třeba se řídit doporučeními v aplikačních tabulkách tohoto katalogu.

ВНИМАНИЕ !!!

Эта сравнительная таблица только информационная.

Свечи зажигания различных изготовителей не имеют идентичные калильные числа из-за разной конструкции и применяемым материалам.

Для правильного выбора свечи зажигания необходимо руководствоваться рекомендациями в таблицах этого каталога.



AC DELCO	BRISK	AC DELCO	BRISK	AUTOLITE	BRISK
40TS	HR14YC	R42-6FS	NR15YC	45	FR17YC
41-2XLS	L14YC	R42CLTS	GR15YC	46	FR17YC
41-4XLS	L15YC	R42CXLS	LR15YC	52	L14YC
41-983	GR17LP-5	R42XLS	LR15YC	53	L15YC
41TS	HR15YC	R43C	KR17C	54	L15YC
41XL	LR12C	R43CFS	NR15YC	55	L17YC
41XLS	L14YC	R43FS	NR15YC	56	L17YC
420Z	N19C	R44CXLS	LR17YC	62	L14YC
422Z	N19C	R44XLS	LR17YC	63	LR15YC
425Z	N17C	R45NS	LR17YC	64	LR15YC
42-6FS	N15YC	R45XLS	LR17YC	65	LR17YC
42F	N15C	R83CTS	FR15YC	65	LR17YC
42FS	N15YC	R83TS	FR15YC	66	LR17YC
42LTS	G15YC	S44F	N19C	74	K15YC
42XL	L14C	S44XL	L17C	75	K17Y
42XLS	L15YC	S45F	N19C	76	K17Y
430Z	N14C			84	K15YC
43FS	N15YC	ALFA ROMEO	BRISK	85	K17Y
43N	L15C	5519 0788	BR14YC-9	94	G14YC
43TS	HR15YC	5519 07880	BR14YC-9	102	G14YC
43XL	L14C	5894 587	LR15YC	103	GR15YC
43XLS	L15YC	5984 036	LR15YC	104	GR15YC
438XLS	LR12YC	6056 9086	LR15YP	105	GR17YC
44	K17C	6056 9957	DR15YP	106	GR17YC
44F	N19C	6057 9903	DR15YP	115	FR15C
44FFS	N17YC	6059 9495	AR14YS	117	FR15C
44N	L17C	7171 1640	LR15YC	124	FR15C
44NS	L17YC	7554 444	LR15YC	156	F17YC
44TS	HR17YC	7760 382	LR15YC	166	FR17YC
44XL	L17C	961 962 4580	DR17LDC-1	175	K17Y
44XLO	L17YC	962 800 0280	DR15LDC	203	HR15YS
44XLS	L17YC	ALPINA	BRISK	235	P17
440XLS	LR12YC	12 12 9 064 619	DR15LDC	245	PR17
45	K19	APRILIA	BRISK	253	P15
445Z	N14C	0297542	BR12S	254	P17
45F	N19C	0297830	LR10SL	255	P17
45FFS	N17YC	0297921	AR12YS	273	N15YC
45NS	L17YC	0297942	BR10YS-9	274	N15YC
45XL	L17C	0297945	AR08GS	275	N17YC
45XLS	L17YC	0897055	LR14C	276	N17YC
46N	L19	2BEN000088	NR12YC	283	NR14YC
46XL	L19	2BEN000181	AR12YS	284	NR15YC
83CTS	FR15YC	8122586	BR14S	294	K17C
83TS	FR15YC	8206870	NR14C	295	K19
C42CFS	N15YC	8206871	NR14C	297	K19
C42CLTS	GR15YC	8550352	AR14YS	302	K17C
C42CXLS	L15YC	8600008	LR11S	303	K17C
C42LTS	GR15YC	AUDI = VW GROUP	BRISK	304	K17C
C43N	L17C	AUTOLITE	BRISK	306	K19
C44N	L17C	12	HR14YS	314	K17C
CFR1CLS	DR14YC	13	HR15YS	315	K17C
CFR2CLS	DR15YC	14	HR15YS	316	K17C
CR42CXLS	LR15YC	15	HR17YC	317	K19
FR2LS	DR15YC	23	HR15YS	354	K17C
FR2LSK	DR15YC	24	HR15YS	355	K17C
FR3CLS6	DR17YC-1	25	HR17YC	356	K19
FR3LS	DR17YC	34	F15YC	357	K19
FR3LS6	DR17YC-1	35	F17YC	363	K17C
FR5LS	DR17YC	36	F17YC	393	L14C
M42FF	N15C	37	F17YC	394	L15C
M45FF	N19C	43	FR15YC	395	L17C
		44	FR15YC		



AUTOLITE		BRISK		AUTOLITE		BRISK		AUTOLITE		BRISK	
396	L17C	2954	U15	4093	N14C						
397	L17C	2956	U17	40T5	HR14YS						
398	L19	2974	P15Y	4113	N15YC						
402	LR14C	2976	PR15Y	4114	N15YC						
403	LR15C	3014	K17C	4123	NR15YC						
404	LR15C	3055	FR15C	4132	B12C						
405	LR17C	3203	LR15YC	4143	BR12S						
406	LR17C	3204	LR15YC	4152	BR10YS-9						
411	N12C	3205	LR17YC	4153	BR12YC-9						
413	N14C	3206	LR17YC	4162	BR10YS-9						
414	N15C	3207	LR17YC	4163	BR12S						
415	N17C	3224	K15YC	4164	B14C						
416	N17C	3225	K17Y	4193	NAR14YC						
417	N19C	3226	K17Y	4194	NAR14YC						
424	N15C	3227	K17Y	4203	NAR14YC						
425	NR17C	3243	GR15YC	4251	L12YC						
426	NR17C	3244	GR15YC	4252	L14YC						
456	JR17	3245	GR17YC	4253	L15YC						
458	JR19	3246	GR17YC	4263	LR15YC						
483	GR14S	3286	FR15YC	4265	LR17YC						
536	N19C	3303	HR15YS	4275	K17Y						
664	HR15YS	3345	PR15	9062	LR15TC						
723	HR15YS	3364	NR15YC	9063	LR15TC						
724	HR15YS	3382	K17C	9064	LR17TC						
725	HR17YC-1	3383	K17C	9921	DR15TC						
726	HR19YC	3384	K17C	AP63	DR15YP						
727	HR19YC-1	3386	K17C	APP5245	GR17LP-5						
744	FR17YC	3388	K17C	BERU	BRISK						
746	FR17YC	3404	FR15C	10 FR-4 AU	NAR12YS						
747	FR17YC	3426	K17C	10 FR-6 CPU03	AR14YS						
764	GR15YC	3462	LR14C	12-5 DU	BR12YC						
765	GR17YC	3463	LR15C	12 FR-5 DU	BR12YC-9						
766	GR17YC	3464	LR15C	12 FR-5 SDU	MR12YS						
784	FR15C	3465	LR17C	12 FR-6 DUT	BR14YC						
804	FR15C	3466	LR17C	12 FR-7 DU	BR15YC						
865	GR17YC	3485	NR17C	12 VR-8 SE	MR14LC						
935	LR17YC	3486	NR17C	14-5 AU	N14C						
945	LR17YC	3565	GR17YC	14-5 B	N12YC						
2414	L10SL	3666	J17	14-5 BU	N12YC						
2415	L11SL	3684	NR14C	14-5 DTU	LR12TC						
2416	LR12SL	3686	NR15C	14-5 DU	L12YC						
2585	LR17YC	3702	LR12C	14-6 BU	N14YC						
2592	LR12SL	3703	LR12C	14-6 DTU	LR14TC						
2593	LR12C	3704	LR14C	14-6 DU	L14YC						
2594	LR12C	3705	LR15C	14-6 DU0	L14YC						
2611	LR12SL	3706	LR15C	14-7 AU	N15C						
2612	LR12C	3724	GR17YC	14-7 BU	N15YC						
2613	LR12C	3922	DR14YC	14-7 CU	L15C						
2614	L14C	3924	A-line 28	14-7 DTU	LR15TC						
2615	L14C	3926	DR17YC	14-7 DU	L15YC						
2616	L15C	3954	B12C	14-7 DU0	L15YC						
2635	N14C	3964	BR12S	14-8 AU	N17C						
2636	N14C	4043	LR15YC-1	14-8 BU	N17YC						
2653	N14C	4052	LR12C	14-8 DTU	LR17TC-1						
2654	N14C	4053	LR12C	14-8 DU	L17YC						
2655	N15C	4054	LR14C	14-8 DU0	L17YC						
2656	N17C	4055	LR14C	14-8 LUR	LR17YC						
2755	B12C	4056	L15C	14-9 DTU	LR17YC						
2794	NAR12YS	4062	LR12C	14-9 DU	L17YC						
2795	NAR14YC	4063	LR12C	14-9 DU0	L17YC						
2796	NAR15YS	4092	N14C	14-9 EU0	K17C						



BERU	BRISK
14 F-5 DPURS2	DR12YP
14 F-5 DU	D12YC
14 F-5 MPUR03	ER12S
14 F-6 DPUR021	DR14YP
14 F-6 DPUR2	DR14YP
14 F-6 DSR	DR14YC
14 F-6 DTU (0,8mm)	DR14TC
14 F-6 DTU (1,0mm)	DR14TC-1
14 F-6 DU0	D14YC
14 F-6 DUOR	DR14YC
14 F-6 KPURW2	DR14YP
14 F-7 DPUR02	DR15YP
14 F-7 DPURX2	DR15YP-1
14 F-7 DU	D15YC
14 F-7 DU0	D15YC
14 F-7 DUOR	DR15YC
14 F-7 HPURX2	DOX15LE-1
14 F-7 HUR2	DOX15LE-1
14 F-7 HURU02	DOX15LE-1
14 F-7 LDUR4	DR15LDC
14 F-8 DPURX02	DR17YP-1
14 F-8 DU	D17YC
14 F-8 DU0	D17YC
14 F-8 DU4	D17YC
14 F-8 DUR	DR17YC
14 F-8 LDUSR	DR17LDC
14 F-8 LUR	DR17YC
14 F-9 DU0	D17YC
14 FGH-6 DTUR	DR14TC
14 FGH-7 DTURX	DX15LTC-1
14 FGH-7 DTURX0	DR15TC-1
14 FGH-8 DPURX2	DR17YP-1
14 FGH-8 DTUR	DR17TC
14 FGH-8 DTURX0	DR17TC-1
14 FGH-8 DTUTRW	DR17TC
14 FGR-6 DDU	DR14TC-1
14 FGR-8 CTU	DR17TC-1
14 FR-5 DTU	DOR12DS
14 FR-5 DU	DR12YC
14 FR-5 LDU	DOR12DS
14 FR-5 LDU3	DOR12DS
14 FR-6 DP0X	DR14YP-1
14 FR-6 DPUX	DR14YP-1
14 FR-6 DPUX02	DR14YP-1
14 FR-6 DU	DR14YC
14 FR-6 DUW	DR14YC
14 FR-6 DUX	DR14YC-1
14 FR-6 LDU	DR14TC
14 FR-6 LDU3	DOR14DS
14 FR-7 DPU2	DR15YP
14 FR-7 DPU3	DR15YP
14 FR-7 DPUX02	DR15YP-1
14 FR-7 DU	DR15YC
14 FR-7 DU2	DR15YC-9
14 FR-7 DU2S	DR15YC
14 FR-7 DU2T	DR15YC
14 FR-7 DUW	DR15YC
14 FR-7 DUX	DR15YC-1
14 FR-7 HUX	DOX15LE-1
14 FR-7 KDU	DR15LDC
14 FR-7 KPU	DR15YP

BERU	BRISK
14 FR-7 KPUX	DR15YP-1
14 FR-7 KU	DR15LC
14 FR-7 KU0	DR15LC
14 FR-7 KU0X	DR15LC-1
14 FR-7 LDU	DR15LDC
14 FR-7 LDUW	DR15LDC
14 FR-7 LPUT02	P1
14 FR-7 LUX	DR15LC-1
14 FR-7 MU2	ER15YC-1
14 FR-7 MUX2	ER15YC-1
14 FR-7 SPUX03	A-line 40
14 FR-8 DPU2	DR17YP
14 FR-8 DU	DR17YC
14 FR-8 DUS	DR17YC
14 FR-8 DUW	DR17YC-9
14 FR-8 DUX	DR17YC-1
14 FR-8 HU	DR17LC
14 FR-8 HUT	DR17LC
14 FR-8 KU	DR17LC
14 FR-8 KU0	DR17LC
14 FR-8 KU0U	DR17LC-1
14 FR-8 LDU0X4	DR17LDC-1
14 FR-8 LDU3	DR17LDC-1
14 FR-8 LU2	DR17LC-9
14 FR-8 MPUX02	ER17YP-1
14 FR-8 MPUX2	ER17YP-1
14 FR-8 MU2	ER17YC-9
14 FR-9 KUX2	DR17LC-1
14 GH-7 DTUR	LR15TC
14 GH-8 DTUR	LR17TC
14 GH-8 DTURX	LR17TC-1
14 GR-8 DTU	LR17TC
14 K-5 DU	G12YC
14 K-5 DU0	G12YC
14 K-6 DU	G14YC
14 K-6 DU0	G14YC
14 K-7 DU	G15YC
14 K-7 DU0	G15YC
14 K-8 DU	G17YC
14 K-8 DU0	G17YC
14 K-9 BU	HR17YC
14 K-9 DU0	G17YC
14 KR-6 BU	HR14YC
14 KR-6 DPUV02	GR15YP-3
14 KR-6 DU	GR14YC
14 KR-6 KPUV02	P6
14 KR-6 MPX	A-line 25
14 KR-7 DU	GR15YC
14 KR-7 DUX	GR15YC-1
14 KR-8 DPU0V	GR17YP-3
14 KR-8 DPUV	GR17YP-3
14 KR-9 DUX	GR17YC-1
14 R-5 DU	LR12YC
14 R-6 DU	LR14YC
14 R-6 DUX	LR14TC-1
14 R-7 BU	NR15YC
14 R-7 CU	LR15C
14 R-7 DU	LR15YC
14 R-7 DUX	LR15YC-1
14 R-8 DU	LR17YC
14 R-8 DU4	LR17YC

BERU	BRISK
14 R-8 DUX	LR17YC-1
14 R-9 DU	LR17YC
14 R-9 EU0	KR17C
14 S-5 F	P15Y
14 S-7 E	P17
14 S-7 EU0	K17C
14 S-7 F	P17Y
14 S-9 E0	J17
14 S-10 E0	J19
14 SR-5 F	PR15Y
14 SR-6 F	PR17YC
14 SR-7 E	PR17
14 SR-7 F	PR17Y
14 SR-9 E0	JR17
14 SR-10 E0	JR19
14-X AU	N19C
14 Z-3 AU	N11S
14 Z-4 AU	NR12S
18 K-6 BU	F14YC
18 K-7 BU	F15YC
18 K-9 BU	F17YC
Z 1	L17YC
Z 15B	L17YC
Z 2	LR17TC-1
Z 25B	LR17TC-1
Z 3	LR17YC
Z 35B	LR17YC
Z 4	DR17YC
Z 45B	DR17YC
Z 5	D17YC
Z 55B	D17YC
Z 6	G17YC
Z 65B	G17YC
Z 7	G17YC
Z 75B	G17YC
Z 8	LR17YC
Z 85B	LR17YC
Z 9	LR17YC-1
Z 95B	LR17YC-1
Z 10	N15YC
Z 105B	N15YC
Z 11	L15YC
Z 115B	L15YC
Z 12	LR15TC
Z 125B	LR15TC
Z 13	DR15YC
Z 135B	DR15YC
Z 14	DR15LDC
Z 145B	DR15LDC
Z 15	DR15YC
Z 155B	DR15YC
Z 16	DR15YC-1
Z 165B	DR15YC-1
Z 17	G15YC
Z 175B	G15YC
Z 18	G15YC
Z 185B	G15YC
Z 19	NR15YC
Z 195B	NR15YC
Z 20	LR15YC
Z 205B	LR15YC



BERU	BRISK
Z 21	LR15YC-1
Z 21SB	LR15YC-1
Z 22	L14YC
Z 22SB	L14YC
Z 23	DR14YC
Z 23SB	DR14YC
Z 24	DR14YC
Z 24SB	DR14YC
Z 25	G14YC
Z 25SB	G14YC
Z 26	GR14YC
Z 26SB	GR14YC
Z 27	LR14YC
Z 27SB	LR14YC
Z 28	LR14TC-1
Z 28SB	LR14TC-1
Z 29	D12YC
Z 29SB	D12YC
Z 30	DR12YC
Z 30SB	DR12YC
Z 31	G12YC
Z 31SB	G12YC
Z 32	F15YC
Z 32SB	F15YC
Z 33	F14YC
Z 33SB	F14YC
Z 35	BR12YC
Z 36	BR12YC
Z 37	N11S
Z 38	L11SL
Z 39	NR12S
Z 40	N14C
Z 41	N12YC
Z 42	L12YC
Z 43	L12YC
Z 44	LR12TC
Z 45	DOR12DS
Z 46	G12YC
Z 47	LR12YC
Z 48	N14YC
Z 49	HR14YC
Z 50	L14YC
Z 51	LR14TC
Z 52	DR14TC
Z 53	DR14TC-1
Z 54	D14YC
Z 55	G14YC
Z 56	G14YC
Z 57	N15C
Z 58	L15C
Z 59	LR15C
Z 61	L15YC
Z 62	L15YC
Z 63	D15YC
Z 63SB	D15YC
Z 64	D15YC
Z 67	GR15YC-1
Z 67SB	GR15YC-1
Z 68	N17C
Z 69	L17YC
Z 70	L17YC

BERU	BRISK
Z 71	D17YC
Z 72	DR17YC
Z 73	DR17YC-1
Z 74	DR17LDC-1
Z 74SB	DR17LDC-1
Z 76	L17YC
Z 76SB	L17YC
Z 77	L17YC
Z 78	LR17YC
Z 79	D17YC
Z 80	G17YC
Z 81	G17YC
Z 82	LR17YC
Z 83	K17C
Z 84	KR17C
Z 85	N19C
Z 89	DR14TC
Z 89SB	DR14TC
Z 90	DX15LTC-1
Z 90SB	DX15LTC-1
Z 91	LR15TC
Z 91SB	LR15TC
Z 92	LR17TC
Z 92SB	LR17YC
Z 93	LR17TC-1
Z 93SB	LR17TC-1
Z 94	LR17TC
Z 94SB	LR17TC
Z 95	GR15YC
Z 95SB	GR15YC
Z 97	A-line 25
Z 97SB	A-line 25
Z 98	DR15LDC
Z 99	DR14YC-1
Z 100	D17YC
Z 100 SB	D17YC
Z 101	DR17LDC
Z 105	DR14YC
Z 105 SB	DR14YC
Z 106	PR17YC
Z 116	DR14TC
Z 117	GR17YC-1
Z 118	N17YC
Z 119	LR17YC
Z 119 SB	LR17YC
Z 120	DR15TC-1
Z 120 SB	DR15TC-1
Z 121	DR17TC-1
Z 121 SB	DR17TC-1
Z 122	DR17YP-1
Z 123	DR15LDC
Z 126	DR17TC
Z 132	P17Y
Z 145	DR14TC-1
Z 148	GR17YP-3
Z 148 SB	GR17YP-3
Z 149	DR15YP-1
Z 151	DR15YP
Z 151	DR15YS
Z 152	DR17LC
Z 153	DR17LC

BERU	BRISK
Z 153 SB	DR17LC
Z 154	DR17LC
Z 154 SB	DR17LC
Z 155	DR15LC
Z 155 SB	DR15LC
Z 156	DR15LC
Z 156 SB	DR15LC
Z 157	DR15LC-1
Z 158	DR15LC-1
Z 158 SB	DR15LC-1
Z 159	DR14YP-1
Z 170	DR14YP
Z 171	DR15YP-1
Z 174	HR17YC
Z 175	F17YC
Z 176	DOX15LE-1
Z 176 SB	DOX15LE-1
Z 183	DR17YC-9
Z 183 SB	ER17YC-9
Z 184	ER15YC-1
Z 184 SB	ER15YC-1
Z 185	DR14YP
Z 188	DR15YP
Z 188 SB	DR15YP
Z 192	DOR12DS
Z 193	DR15YC-9
Z 193 SB	DR15YC-9
Z 194	DOR14DS
Z 198	DOR12DS
Z 199	NAR12YS
Z 200	DOX15LE-1
Z 200 SB	DOX15LE-1
Z 203	DR17LC-9
Z 204	DR17TC-1
Z 206	DR15YP
Z 208	DR17LDC-1
Z 209	GR15YP-3
Z 210	AR14YS
Z 219	ER17YP-1
Z 220	DR17LC-1
Z 221	DR14YP-1
Z 224	DR15YP
Z 225	DOX15LE-1
Z 227	DR17YC
Z 228	DR15YP-1
Z 230	P6
Z 234	BR15YC
Z 235	A-line 40
Z 238	DR17YP
Z 240	DR17YP-1
Z 240 SB	DR17YP-1
Z 243	MR14LC
Z 243 SB	MR14LC
Z 246	DR17TC
Z 247	DR15YC
Z 248	DR17LC
Z 249	DR17LC-1
Z 250	DR15YC
Z 251	DR15YC
Z 252	DR14YC
Z 254	DR17YC



BERU	BRISK	BOSCH	BRISK	BOSCH	BRISK
Z 255	DR17YC-9	0 241 050 002	NAR14YC	0 241 229 574	L17YC
Z 257	DR15LDC	0 241 050 002	NAR14YS	0 241 229 578	N17YC
Z 260	PR15Y	0 241 056 501	AR14YS	0 241 229 579	L17C
Z 261	JR19	0 241 140 500	BR14YC	0 241 229 580	K17C
Z 262	J17	0 241 140 504	BR14YC	0 241 229 588	L17YC
Z 263	PR17Y	0 241 145 003	BR12YC	0 241 229 594	HR17YC
Z 265	P15Y	0 241 145 500	BR12YC	0 241 229 596	LR17YC-1
Z 266	P17	0 241 145 501	BR12YC	0 241 229 604	N17C
Z 267	K17C	0 241 145 502	BR12YC	0 241 229 610	LR17YP
Z 269	JR17	0 241 145 504	BR12YC	0 241 229 612	N17C
Z 270	J19	0 241 145 505	BR12YC	0 241 229 617	G17YC
Z 271	PR17	0 241 145 507	B12C	0 241 229 618	GR17YC
Z 272	DOX15LE-1	0 241 145 509	BR12YC-9	0 241 229 619	LR17TC
Z 277	ER12S	0 241 145 510	BR12YC	0 241 229 621	LR17YP
Z 284	DR14YP-1	0 241 150 502	BR12S	0 241 229 634	D17YC
Z 286	MR12YS	0 241 150 504	BR12S	0 241 229 636	HR17YC-1
Z 291	BR12YC-9	0 241 155 001	BR10S	0 241 229 639	DR17LC
Z 298	GR17YP-3	0 241 155 500	BR10S	0 241 229 641	N17YC
Z 302	ER17YP-1	0 241 215 503	J19	0 241 229 649	G17YC
Z 303	ER15YC-1	0 241 219 010	N19C	0 241 229 657	DR17LC
Z 322	DR14YPP	0 241 219 537	H19YC	0 241 229 661	LR17TC
Z 346	P1	0 241 219 540	N19C	0 241 229 663	LR17TC-1
Z 347	DR12YP	0 241 219 541	L19	0 241 229 665	LR17TC
Z 358	BR14YC	0 241 219 543	N19C	0 241 229 666	DR17LDC
BMW	BRISK	0 241 219 554	K19	0 241 229 676	DR17TC-1
12 12 0 030 548	DR15LDC	0 241 219 808	K19	0 241 229 682	DR17YC-1
12 12 0 032 134	P1	0 241 219 809	L19	0 241 229 684	DR17YC-1
12 12 0 032 136	DR15LDC	0 241 219 891	N19C	0 241 229 685	D17YC
12 12 0 141 871	DR15LDC	0 241 225 006	L17YC	0 241 229 689	DR17YP-1
12 12 0 148 593	DR15LDC	0 241 225 013	L17YC	0 241 229 703	HR17YC
12 12 1 344 520	DR15LDC	0 241 225 503	L19	0 241 229 704	DR17YP-1
12 12 1 422 087	DR15LDC	0 241 225 543	H19YC	0 241 229 712	D17YC
12 12 1 704 399	DR15LDC	0 241 225 545	L17YC	0 241 229 713	D17YC
12 12 1 705 914	DR15LDC	0 241 225 547	L19	0 241 229 714	N17YC
12 12 1 715 539	DR15LDC	0 241 225 548	K19	0 241 229 715	L17YC
12 12 1 747 061	DR15LDC	0 241 225 549	N19C	0 241 229 716	LR17TC
12 12 1 748 002	DR15LDC	0 241 225 550	L17YC	0 241 229 718	N17C
12 12 2 343 144	B12C	0 241 225 551	J17	0 241 229 853	L17YC
12 12 4 353 679	DR15LDC	0 241 225 556	L17YC	0 241 229 856	L17C
12 12 7 526 799	P1	0 241 225 558	G17YC	0 241 229 887	N17C
12 12 7 650 676	DR14TC	0 241 225 573	G17YC	0 241 229 919	N17YC
12 12 7 653 439	AR12YS	0 241 225 574	D17YC	0 241 229 921	L17YC
12 12 7 653 771	DR14TC	0 241 225 576	LR17TC	0 241 229 923	N17C
12 12 7 671 301	BR12YP	0 241 225 582	LR17YC-1	0 241 229 953	LR17LC
12 12 7 671 302	DR14TC	0 241 225 583	DR17LC	0 241 229 954	DR17LC
12 12 7 677 560	BR12YP	0 241 225 587	DR17LC	0 241 229 961	D17YC
12 12 9 059 162	DR15LDC	0 241 225 589	P17	0 241 229 970	U17
12 12 9 059 794	DR15LDC	0 241 225 590	J17	0 241 229 971	K17C
12 12 9 061 382	DR15LDC	0 241 225 593	L17YC	0 241 229 973	NR17C
12 12 9 061 811	DR15LDC	0 241 225 816	L17YC	0 241 229 974	DR17TC-1
12 12 9 061 870	DR17LC	0 241 225 820	L17YC	0 241 235 051	L15YC
12 12 9 063 428	DR15LDC	0 241 225 824	J17	0 241 235 089	L15C
12 12 9 064 617	DR15LDC	0 241 225 825	P17	0 241 235 098	L15C
12 12 9 064 619	DR15LDC	0 241 225 896	J17	0 241 235 099	LR15YC
12 12 9 064 656	DR15LDC	0 241 229 021	L17YC	0 241 235 103	L15YC
12 12 9 065 062	DR15LDC	0 241 229 060	LR17TC-1	0 241 235 108	DR15TC
12 12 9 065 366	DR15LDC	0 241 229 061	L17YC	0 241 235 563	L15YC
12 12 9 071 003	DR15LDC	0 241 229 062	L17YC	0 241 235 564	N15YC
BOSCH	BRISK	0 241 229 541	U17	0 241 235 566	P15
0 241 040 501	NAR17	0 241 229 560	P17	0 241 235 567	P17Y
0 241 045 001	NAR15YS	0 241 229 561	P18Y	0 241 235 574	L15C



BOSCH		BRISK		BOSCH		BRISK		BOSCH		BRISK	
0 241 235 585	N15YC	0 241 236 827	DX15LTC-1	0 241 245 599	L12YC						
0 241 235 594	K17C	0 241 236 828	DR15LDC	0 241 245 601	G12YC						
0 241 235 602	L15YC	0 241 236 834	P17Y	0 241 245 602	N14C						
0 241 235 607	N15C	0 241 236 835	N15C	0 241 245 603	L14C						
0 241 235 610	LR15YC-1	0 241 240 057	L14YC	0 241 245 608	LR12YP						
0 241 235 619	N15C	0 241 240 058	L14YC	0 241 245 610	DR12YP						
0 241 235 627	LR15YP	0 241 240 524	G14YC	0 241 245 615	D12YC						
0 241 235 633	LR15TC-1	0 241 240 530	L14YC	0 241 245 619	N12YC						
0 241 235 635	G15YC	0 241 240 532	N14YC	0 241 245 622	DR12TC						
0 241 235 636	G15YC	0 241 240 539	L14YC	0 241 245 636	G12YC						
0 241 235 643	LR15TC	0 241 240 542	D14YC	0 241 245 641	DR12YC						
0 241 235 645	LR15YP-1	0 241 240 543	HR14YC	0 241 245 642	D12YC						
0 241 235 647	LR15YP	0 241 240 547	G14YC	0 241 245 646	N12YC						
0 241 235 650	D15YC	0 241 240 558	LR14TC	0 241 245 647	G12YC						
0 241 235 663	HR15YC	0 241 240 559	LR14YP	0 241 245 800	N12YC						
0 241 235 668	G15YC	0 241 240 563	G14YC	0 241 245 842	D12YC						
0 241 235 673	D15YC	0 241 240 564	DR14TC	0 241 245 843	N14C						
0 241 235 674	DR15LC	0 241 240 569	DR14YC-1	0 241 245 844	N12YC						
0 241 235 676	D15YC	0 241 240 574	LR14TC-1	0 241 245 845	L12YC						
0 241 235 681	G15YC	0 241 240 578	G14YC	0 241 245 846	L12YC						
0 241 235 682	DR15YC	0 241 240 579	D14YC	0 241 245 849	NR14C						
0 241 235 685	DR15YC-1	0 241 240 581	G14YC	0 241 247 500	LR12YP						
0 241 235 689	LR15YS	0 241 240 585	DR14YS	0 241 248 531	N12C						
0 241 235 690	DR15LDC	0 241 240 587	DR14YC	0 241 248 534	LR12C						
0 241 235 692	DR15LC	0 241 240 590	DR14TC-1	0 241 248 540	N12C						
0 241 235 693	LR15YC-9	0 241 240 592	DR14TC-1	0 241 250 514	G12S						
0 241 235 697	DX15LTC-1	0 241 240 600	P15	0 241 250 526	D12S						
0 241 235 698	LX15LTC-1	0 241 240 601	P15Y	0 241 252 521	NR12S						
0 241 235 704	DR15YC	0 241 240 603	N14C	0 241 252 522	LR12SL						
0 241 235 705	L15YC	0 241 240 604	L14C	0 241 252 898	LR12SL						
0 241 235 706	DR15TC-1	0 241 240 608	D14YC	0 241 255 507	D10S						
0 241 235 715	DOX15LE-1	0 241 240 609	DR14TC	0 241 256 512	N12C						
0 241 235 720	DR15YP	0 241 240 631	ER14YS	0 241 256 514	NR12S						
0 241 235 735	DOX15LE-1	0 241 240 844	L14YC	0 241 256 515	L11SL						
0 241 235 736	DR15YC	0 241 240 846	N14YC	0 241 256 519	N12C						
0 241 235 739	DR15YP-1	0 241 240 847	N14YC	0 241 260 507	N11S						
0 241 235 743	DR15YC	0 241 240 849	G14YC	0 241 260 508	L11SL						
0 241 235 751	DR15LDC	0 241 240 860	L14YC	0 241 260 512	D10S						
0 241 235 752	DX15LTC-1	0 241 240 872	G14YC	0 241 262 505	N11S						
0 241 235 753	G15YC	0 241 240 873	G14YC	0 241 262 506	L10SL						
0 241 235 754	N15YC	0 241 240 874	N14YC	0 241 265 501	D08S						
0 241 235 755	L15YC	0 241 240 875	L14YC	0 241 265 502	D08S						
0 241 235 756	LR15TC	0 241 240 877	D14YC	0 241 268 505	N10S						
0 241 235 757	LX15LTC-1	0 241 240 883	LR14TC	0 241 268 506	L10SL						
0 241 235 759	P17Y	0 241 240 885	DR14TC	0 241 268 508	D08S						
0 241 235 911	L15YC	0 241 240 890	DR14TC	0 241 325 509	F17YC						
0 241 235 914	L15C	0 241 240 895	DR14YC	0 241 329 518	F17YC						
0 241 235 916	N15C	0 241 245 070	LR12TC	0 241 329 520	F17YC						
0 241 235 959	G15YC	0 241 245 071	L12YC	0 241 329 522	FR17C						
0 241 235 960	N15C	0 241 245 539	U15	0 241 329 804	F17YC						
0 241 235 961	N15YC	0 241 245 552	L12YC	0 241 335 516	F15YC						
0 241 235 962	L15C	0 241 245 553	N12YC	0 241 335 520	FR15C						
0 241 235 963	L15YC	0 241 245 554	P15	0 241 335 528	F15YC						
0 241 235 964	L15YC	0 241 245 555	P15Y	0 241 335 807	F15YC						
0 241 235 965	N15C	0 241 245 570	G12YC	0 241 340 501	F14YC						
0 241 235 976	LR15TC	0 241 245 574	NR12S	0 241 340 805	F14YC						
0 241 235 982	LR15TC	0 241 245 575	LR14S	0 242 035 500	TR15C						
0 241 235 998	L15YC	0 241 245 579	G12YC	0 242 040 502	AR14YS						
0 241 235 999	DR15YC	0 241 245 580	N14C	0 242 050 501	NAR14YC						
0 241 236 818	LX15LTC-1	0 241 245 581	L14C	0 242 050 501	NAR14YS						
0 241 236 826	DR15LDC	0 241 245 593	D12YC	0 242 050 502	TR14C						



BOSCH	BRISK
0 242 050 502	TR14S
0 242 055 501	NAR14YC
0 242 055 501	NAR14YS
0 242 055 502	AR14YS
0 242 060 500	NAR12YS
0 242 060 501	AR12YS
0 242 129 508	MR14LC
0 242 129 510	MR14LC
0 242 129 515	QR15LC-1
0 242 135 515	BR15YC
0 242 135 527	QR15LC-1
0 242 135 802	BR15YC
0 242 140 514	P10
0 242 145 500	BR12YC
0 242 145 501	BR12YC
0 242 145 502	BR12S
0 242 160 501	BR12S
0 242 215 502	JR19
0 242 215 801	JR19
0 242 225 524	LR17YC-9
0 242 225 529	HR17C
0 242 225 531	HR17YC
0 242 225 533	GR17YC
0 242 225 534	GR17YC-1
0 242 225 536	JR17
0 242 225 538	LR17YC
0 242 225 548	LR17YC-1
0 242 225 549	DR17YC-1
0 242 225 550	LR17YC
0 242 225 553	LR17YP
0 242 225 554	LR17YP-1
0 242 225 580	DR17LC-1
0 242 225 582	DR17YC
0 242 225 599	LR17YC
0 242 225 623	GR17YC
0 242 225 859	LR17YC-9
0 242 225 859	LR17YS-9
0 242 225 862	PR17
0 242 225 898	JR17
0 242 229 514	PR18Y
0 242 229 528	HR17YC
0 242 229 530	DR17YC-1
0 242 229 531	LR17YC-9
0 242 229 533	LR17C
0 242 229 534	NR17C
0 242 229 535	LR17YP
0 242 229 537	LR17YS
0 242 229 538	LR17YC
0 242 229 543	DR17YP-1
0 242 229 545	A-line 31
0 242 229 555	LR17YP
0 242 229 557	LR17YP-1
0 242 229 559	GR17YC-1
0 242 229 566	LR17YP-1
0 242 229 568	DR17YC
0 242 229 570	LR17YC
0 242 229 576	DR17LC-1
0 242 229 586	NR17YC
0 242 229 587	DR17YC
0 242 229 591	DR17LDC
0 242 229 594	DR17YC

BOSCH	BRISK
0 242 229 598	DR17YS-9
0 242 229 605	DR17LDC
0 242 229 606	DR17LDC
0 242 229 607	LR17YC
0 242 229 610	NR17YC
0 242 229 615	DR17LDC-1
0 242 229 619	DR17YC-1
0 242 229 625	DR17TC-1
0 242 229 626	DR17LDC-1
0 242 229 628	DR17LDC-1
0 242 229 630	ER17YC-9
0 242 229 632	LR17YC-9
0 242 229 635	DR17LC-1
0 242 229 641	A-line 31
0 242 229 642	ER17YC-9
0 242 229 643	PR17
0 242 229 652	GR17YP-3
0 242 229 654	DR17LDC-1
0 242 229 655	GR17YS
0 242 229 656	A-line 6
0 242 229 657	NR17YC
0 242 229 658	A-line 21
0 242 229 659	A-line 32
0 242 229 660	A-line 36
0 242 229 673	DR17YC
0 242 229 687	A-line 38
0 242 229 699	DR17LC-1
0 242 229 702	ER17YC-9
0 242 229 705	LR17LC
0 242 229 706	DR17TC-1
0 242 229 708	ER17YP-1
0 242 229 712	DR17LC
0 242 229 713	DR17YP-1
0 242 229 715	DR17LC
0 242 229 724	DR17YC-9
0 242 229 779	LR17LC
0 242 229 782	DR17LDC-1
0 242 229 799	DR17TC-1
0 242 229 804	LR17YC
0 242 229 831	DR17YC-1
0 242 229 832	LR17YC-1
0 242 229 833	LR17YC-1
0 242 229 838	DR17YC-1
0 242 229 864	LR17YC
0 242 229 876	DR17YC
0 242 229 878	DR17LDC-1
0 242 229 879	GR17YC
0 242 229 880	LR17YC
0 242 229 881	NR17YC
0 242 229 882	LR17TC-1
0 242 229 883	DR17YC
0 242 229 884	DR17YC-1
0 242 229 885	LR17YC-1
0 242 229 924	DR17TC-1
0 242 229 925	DR17YP-1
0 242 229 984	LR17YC
0 242 229 985	DR17YC
0 242 230 500	DR17YP-1
0 242 235 511	LR15YC
0 242 235 522	NR15YC
0 242 235 525	LR15YS-9

BOSCH	BRISK
0 242 235 526	LR15YS
0 242 235 529	LR15YC
0 242 235 530	LR15YC-1
0 242 235 531	NR15C
0 242 235 532	LR15C
0 242 235 533	NR15C
0 242 235 536	LR15YP
0 242 235 537	LR15YC
0 242 235 538	GR15YC
0 242 235 540	LR15YP-1
0 242 235 541	LR15YP
0 242 235 542	GR15YC-1
0 242 235 543	LR15C-1
0 242 235 544	DR15YC-1
0 242 235 547	DR15YP-1
0 242 235 549	DR15YP
0 242 235 554	KR17C
0 242 235 551	DR15YC
0 242 235 556	DR15YP
0 242 235 564	DR15TC
0 242 235 566	GR15YC-1
0 242 235 567	DR15LC-1
0 242 235 571	LR15TC
0 242 235 573	DR15YP-1
0 242 235 574	LR15YP-1
0 242 235 579	DR15YC
0 242 235 587	DR15YC
0 242 235 588	DR15LC
0 242 235 589	DR15LDC
0 242 235 590	LR15TC
0 242 235 592	GR15YC-1
0 242 235 597	DR15YC
0 242 235 599	DR15LC
0 242 235 602	DR15LC-1
0 242 235 605	DR15LDC
0 242 235 609	DR15LDC-1
0 242 235 610	DR15LC
0 242 235 612	DR15YC-1
0 242 235 616	DR15YC
0 242 235 623	DX15LTC-1
0 242 235 624	DR15YC-9
0 242 235 625	DR15LDC
0 242 235 630	LR15YC-9
0 242 235 636	ER15YC-1
0 242 235 640	DR15YC-9
0 242 235 643	A-line 25
0 242 235 644	DR15YC-9
0 242 235 646	DR15YC-1
0 242 235 648	DR15LDC-1
0 242 235 651	PR17Y
0 242 235 658	A-line 25
0 242 235 659	DR15LC-1
0 242 235 661	A-line 7
0 242 235 662	A-line 25
0 242 235 663	A-line 2
0 242 235 664	A-line 37
0 242 235 665	NR15YC
0 242 235 666	DR15YC-9
0 242 235 667	A-line 11
0 242 235 668	A-line 20
0 242 235 690	DR15YP-1



BOSCH	BRISK	BOSCH	BRISK	BOSCH	BRISK
0 242 235 692	DOX15LE-1	0 242 236 561	DR15LC	0 242 240 847	NR14YC
0 242 235 699	DR15YP	0 242 236 563	GR15YP-1	0 242 240 848	GR14YC
0 242 235 700	GR15YS	0 242 236 564	DR15YP	0 242 240 849	LR14YC
0 242 235 707	A-line 10	0 242 236 565	DOX15LE-1	0 242 240 850	DR14YC
0 242 235 733	GR15YP-1	0 242 236 566	P1	0 242 240 860	DR14YP-1
0 242 235 746	A-line 25	0 242 236 571	P4	0 242 245 018	DOR12DS
0 242 235 749	DR15YP	0 242 236 576	LR15YP	0 242 245 514	LR12YS
0 242 235 758	ER15YC-1	0 242 240 506	PR15Y	0 242 245 515	DR12YC
0 242 235 761	DOX15LE-1	0 242 240 511	LR14YC	0 242 245 516	LR12YC
0 242 235 762	NR15YC-1	0 242 240 514	GR14YC	0 242 245 517	NR14C
0 242 235 763	P3	0 242 240 516	LR14YS	0 242 245 519	DR12YP
0 242 235 764	P1	0 242 240 519	GR14YS	0 242 245 520	DR12YP
0 242 235 766	DR15TC-1	0 242 240 520	HR14YC	0 242 245 521	LR14C
0 242 235 767	P5	0 242 240 521	LR14YP	0 242 245 527	GR12YC
0 242 235 769	P3	0 242 240 526	DR14YC	0 242 245 533	PR15Y
0 242 235 775	P1	0 242 240 528	DR14TC	0 242 245 536	DR12YC
0 242 235 776	DR15YP-1	0 242 240 530	DR14YP	0 242 245 537	LR12YC
0 242 235 791	ER15YC-1	0 242 240 531	LR14TC-1	0 242 245 550	DR12YC-1
0 242 235 810	NR15YC	0 242 240 532	LR14YP-1	0 242 245 552	LR12YS
0 242 235 811	LR15YC	0 242 240 533	DR14YP-1	0 242 245 576	DR12YP
0 242 235 848	LR15YC-1	0 242 240 539	DR14YC-1	0 242 245 801	DR12YC
0 242 235 849	DR15YC-1	0 242 240 546	LR14TC	0 242 245 811	NR14C
0 242 235 865	GR15YC	0 242 240 547	DR14TC	0 242 245 812	LR12YC
0 242 235 866	GR15YC-1	0 242 240 548	DR14YP	0 242 250 503	LR12C
0 242 235 877	DR15YC	0 242 240 549	DR14YP	0 242 250 506	NR12C
0 242 235 883	DR15LDC	0 242 240 554	DR14YC	0 242 255 502	LR12SL
0 242 235 900	NR15C	0 242 240 557	DR14LDC	0 242 256 513	LR12SL
0 242 235 904	DR15LC	0 242 240 558	DR14YS	0 242 256 522	LR12SL
0 242 235 905	A-line 25	0 242 240 561	NR14YC	0 242 325 501	FR17YC
0 242 235 908	GR15YC	0 242 240 562	DR14LDC-1	0 242 329 503	FR17YC
0 242 235 909	LR15YC	0 242 240 564	DR14LDC	0 242 335 503	FR15YC
0 242 235 910	LX15LTC-1	0 242 240 566	DR14LDC	0 242 335 504	FR15YC
0 242 235 911	NR15YC	0 242 240 572	DR14TC	0 242 335 801	FR15YC
0 242 235 912	DR15YC-9	0 242 240 576	PR15Y	0 242 340 501	FR14YC
0 242 235 913	DR15YC-1	0 242 240 577	DR14YC	D 6 BC	F14YC
0 242 235 914	DR15LDC	0 242 240 579	LR14YC	D 7 AC	FR15C
0 242 235 915	LR15YC-1	0 242 240 580	LR14YC	D 7 BC	F15YC
0 242 235 916	A-line 25	0 242 240 582	PR15	D 8 AC	FR17C
0 242 235 918	DR15YP	0 242 240 585	NR14C	D 8 B	F17YC
0 242 235 943	DR15YC	0 242 240 586	LR14C	D 8 BC	F17YC
0 242 235 946	LR15YC	0 242 240 591	GR14YS	D 9 BC	F17YC
0 242 235 947	DR15LDC	0 242 240 592	A-line 19	DR 6 BC	FR14YC
0 242 235 950	GR15YC	0 242 240 593	A-line 33	DR 7 BC	FR15YC
0 242 235 952	P1	0 242 240 605	DR14YC	DR 8 BC	FR17YC
0 242 235 953	NR15YC	0 242 240 614	DR14YP	DR 9 BC	FR17YC
0 242 235 979	GR15YC-1	0 242 240 615	DR14YP-1	F 08 CS	DO8S
0 242 235 980	DR15LC	0 242 240 618	DR14TC-1	F 09 CS	DO8S
0 242 235 982	DR15YP	0 242 240 619	ER14YS	F 09 DC	DO8S
0 242 235 983	DOX15LE-1	0 242 240 621	DR14YP-1	F 2 CS	D10S
0 242 235 984	P1	0 242 240 625	DR14YP	F 3 CS	D10S
0 242 235 985	DR15LC-1	0 242 240 627	DR14YP	F 4 CS	D12S
0 242 235 986	DR15LC-1	0 242 240 628	DR14YP	F 5 DC	D12YC
0 242 235 987	DR15YP-1	0 242 240 649	DR14YP-1	F 5 DP	DR12YP
0 242 236 510	A-line 40	0 242 240 650	DR14YP	F 5 DPOR	DR12YP
0 242 236 511	DR15YP	0 242 240 653	P9	F 5 DTC	DR12TC
0 242 236 530	DOX15LE-1	0 242 240 813	GR14YC	F 6 DC	D14YC
0 242 236 539	P1	0 242 240 814	LR14YC	F 6 DCOR	DR14YC
0 242 236 541	DR15LC-1	0 242 240 815	LR14YC	F 6 DCX	DR14YC-1
0 242 236 542	DR15LC-1	0 242 240 818	DR14YC	F 6 DPP332	DR14YP
0 242 236 544	A-line 35	0 242 240 831	DR14YC-1	F 6 DSR	DR14YS
0 242 236 560	GR15YC-1	0 242 240 846	PR15Y	F 6 DTC (0,8mm)	DR14TC



BOSCH	BRISK
F 6 DTC (1,0mm)	DR14TC-1
F 6 LTRC	DR14TC-1
F 6 MPP332	ER14YS
F 7 DC	D15YC
F 7 DC0	D15YC
F 7 DC0R	DR15YC
F 7 DCR4	DR15YC
F 7 DCX	DR15YC-1
F 7 DER	DR15YC
F 7 DPP222T	DR15YP
F 7 DPP332	DR15YP-1
F 7 DTC	DR15TC
F 7 HER2	DOX15LE-1
F 7 HPP222	DOX15LE-1
F 7 KTCR	DR15TC-1
F 7 LCO2	DR15LC
F 7 LCR	DR15LC
F 7 LDCR	DR15LDC
F 7 LTRC	DX15LTC-1
F 8 DC	D17YC
F 8 DC0R	DR17YC-1
F 8 DC4	D17YC
F 8 DCX	DR17YC-1
F 8 DPP222U	DR17YP-1
F 8 DPP332	DR17YP-1
F 8 KTCR	DR17TC-1
F 8 LCR	DR17LC
F 8 LCR2	DR17LC
F 8 LDCR	DR17LDC
F 9 DC0	D17YC
F 9 LCR	DR17LC
F 9 LCR2	DR17LC
FLR 7 LDCU	DR15LDC-1
FLR 8 LD+U	DR17LDC-1
FLR 8 LDCU	DR17LDC-1
FLR 8 LDCU+	DR17LDC-1
FQR 7 ME	ER15YC-1
FQR 8 DE	DR17YC-9
FQR 8 LE2	DR17LC
FQR 8 LEU2	DR17LC-1
FR 5 DC	DR12YC
FR 5 DCX	DR12YC-1
FR 5 DP	DR12YP
FR 5 KPP332S	DR12YP
FR 5 LDC	DOR12DS
FR 6 D+	A-line 33
FR 6 DC	DR14YC
FR 6 DC+	A-line 33
FR 6 DC2	DR14YC
FR 6 DCX	DR14YC-1
FR 6 DDC	DR14LDC
FR 6 DE	DR14YC
FR 6 DP	DR14YP
FR 6 DP1	DR14YP
FR 6 DPP22	DR14YP
FR 6 DPP22U	DR14YP-1
FR 6 DPP332	DR14YP
FR 6 DPP33X	DR14YP-1
FR 6 DPX	DR14YP-1
FR 6 DS	DR14YS
FR 6 DTC	DR14TC

BOSCH	BRISK
FR 6 DTCW	DR14TC
FR 6 KDC	DR14LDC-1
FR 6 KI332S	P9
FR 6 KPP332S	DR14YP
FR 6 KPP33+	DR14YP
FR 6 KPP33X+	DR14YP-1
FR 6 KTC	DR14TC
FR 6 LDC	DR14LDC
FR 6 LTC	DR14TC-1
FR 6 MPP332	ER14YS
FR 7 D+	DR15YS-9
FR 7 D+X	A-line 11
FR 7 DC	DR15YC
FR 7 DC+	DR15YC-9
FR 7 DC0	DR15YC
FR 7 DC2	DR15YC-9
FR 7 DC4	DR15YC
FR 7 DC9	DR15YC-9
FR 7 DCU	DR15YC-1
FR 7 DCX	DR15YC-1
FR 7 DCX+	A-line 11
FR 7 DE	DR15YC-9
FR 7 DE2	DR15YC-9
FR 7 DP	DR15YP
FR 7 DP1X	DR15YP-1
FR 7 DPP+	DR15YP
FR 7 DPP10	DR15YP
FR 7 DPP22U	DR15YP-1
FR 7 DPP33	DR15YP
FR 7 DPP332	DR15YP
FR 7 DPX	DR15YP-1
FR 7 DTC	DR15TC
FR 7 HC+	DOX15LE-1
FR 7 HC0X	DOX15LE-1
FR 7 HE02	DOX15LE-1
FR 7 HE2	DOX15LE-1
FR 7 HPP22	P1
FR 7 HPP222	P1
FR 7 HPP33+	P1
FR 7 HPP332W	P1
FR 7 KC	DR15LC
FR 7 KC+	DR15LC
FR 7 KCU	DR15LC-1
FR 7 KCW	DR15LC
FR 7 KCX	DR15LC-1
FR 7 KCX+	DR15LC-1
FR 7 KDC	DR15LDC-1
FR 7 KI332S	P4
FR 7 KPP33+	DR15YP
FR 7 KPP332	DR15YP-1
FR 7 KPP33U+	A-line 35
FR 7 KTC	DR15TC-1
FR 7 LC2	DR15LC
FR 7 LCX	DR15LC-1
FR 7 LCX+	DR15LC-1
FR 7 LD+	A-line 20
FR 7 LDC	DR15LDC
FR 7 LDC+	A-line 20
FR 7 LDC4	DR15LDC
FR 7 LTC	DX15LTC-1
FR 7 ME	ER15YC-1

BOSCH	BRISK
FR 7 NPP332	A-line 40
FR 7 SE	ER15YC-1
FR 7 SI30	P3
FR 8 D+	A-line 32
FR 8 D+X	A-line 36
FR 8 DC	DR17YC
FR 8 DC+	A-line 32
FR 8 DC0	DR17YC
FR 8 DCU	DR17YC-1
FR 8 DCX	DR17YC-1
FR 8 DCX+	A-line 36
FR 8 DE	DR17YC
FR 8 DPP33	DR17YP-1
FR 8 DPP33+	DR17YP-1
FR 8 DPX	DR17YP-1
FR 8 DS	DR17YS-9
FR 8 HDC+	DR17LDC-1
FR 8 KCU	DR17LC-1
FR 8 KDC	DR17LDC-1
FR 8 KTC	DR17TC-1
FR 8 KTC+	DR17TC-1
FR 8 LC	DR17LC
FR 8 LCX	DR17LC-1
FR 8 LDC	DR17LDC
FR 8 LDC4	DR17LDC
FR 8 LTC	DR17TC-1
FR 8 MC9	ER17YC-9
FR 8 ME	ER17YC-9
FR 8 SE0	ER17YC-9
FR 8 SPP332	ER17YP-1
FR 9 DC	DR17YC
FR 9 DCX	DR17YC-1
FR 9 LCX	DR17LC-1
H 4 CS	G12S
H 5 D	G12YC
H 5 DC	G12YC
H 5 DC0	G12YC
H 6 BC	HR14YC
H 6 DC	G14YC
H 6 DC0	G14YC
H 7 BC	HR15YC
H 7 DC	G15YC
H 7 DC0	G15YC
H 8 BC	HR17YC
H 8 BC5	HR17YC
H 8 BCX	HR17YC-1
H 8 DC	G17YC
H 8 DC0	G17YC
H 8 DP	GR17YS
H 9 BC	H19YC
H 9 DC	G17YC
H 9 DC0	G17YC
H 10 BC	H19YC
HR 5 DC	GR12YC
HR 6 BC	HR14YC
HR 6 D+	GR14YS
HR 6 DC	GR14YC
HR 6 DC+	GR14YS
HR 6 DS	GR14YS
HR 7 D+	A-line 7
HR 7 DC	GR15YC



BOSCH	BRISK	BOSCH	BRISK	BOSCH	BRISK
HR 7 DC+	A-line 7	SUPER plus 55	DR14YP	W 7 BC	N15YC
HR 7 DC0	GR15YC-1	U 3 CC	AR14YS	W 7 CC	L15C
HR 7 DCX	GR15YC-1	U 4 AC	NAR14YC	W 7 CC0	L15C
HR 7 DCX+	GR15YC-1	U 4 AC	NAR14YS	W 7 DC	L15YC
HR 7 DP	GR15YS	U 5 AC	NAR15YS	W 7 DC0	L15YC
HR 7 DPP22	GR15YP-1	U 6 AC	NAR17	W 7 DCR	LR15YC
HR 7 KPP33+	GR15YP-1	UR 2 AS	NAR12YS	W 7 DCX	LR15YC-1
HR 7 MPP+	A-line 25	UR 2 CC	AR12YS	W 7 DP	LR15YP
HR 7 MPP+V	A-line 25	UR 3 AC	NAR14YC	W 7 DPX	LR15YP-1
HR 7 MPP22U	A-line 25	UR 3 AC	NAR14YS	W 7 DSR	LR15YS
HR 7 MPP22V	A-line 25	UR 3 AS	NAR14YS	W 7 DTC (0,8mm)	LR15TC
HR 7 MPP302X	P5	UR 3 CC	AR14YS	W 7 DTC (1,0mm)	LR15TC-1
HR 8 BC	HR17YC	UR 4 AC	NAR14YC	W 7 EC	K17C
HR 8 D+	GR17YS	UR 4 AC	NAR14YS	W 7 LTCR	LX15LTC-1
HR 8 DC+	GR17YS	UR 5 DC	AR12YS	W 8 AC	N17C
HR 8 DCX	GR17YC-1	UR 6 DC	AR14YS	W 8 BC	N17YC
HR 8 DPP15V	GR17YP-3	UR 6 DE	AR14YS	W 8 CC	L17C
HR 8 DPP22U	A-line 31	USR 7 AC	TR15C	W 8 D0	L17YC
HR 8 DPX	A-line 31	USR 4 AC	TR14C	W 8 DC	L17YC
HR 9 AC	HR17C	USR 4 AC	TR14S	W 8 DC0	L17YC
HR 9 BC	HR17YC	VR 8 SC+	MR14LC	W 8 DCX	LR17YC-1
HR 9 DC	GR17YC	VR 8 SE	MR14LC	W 8 DP	LR17YP
HR 9 DCX	GR17YC-1	VR 8 SEW	MR14LC	W 8 DTC	LR17TC
HS 5 E	U15	W 08 AS	N10S	W 8 EC	K17C
HS 8 E	U17	W 08 CS	L10SL	W 8 LCR	LR17LC
SUPER plus 1	A-line 2	W 2 A	N11S	W 8 LDRCR	LR17TC
SUPER plus 2	A-line 37	W 2 AC	N11S	W 8 LTCR	LR17TC-1
SUPER plus 3	A-line 6	W 2 AS	N11S	W 9 AC	N19C
SUPER plus 4	A-line 21	W 2 C	L11SL	W 9 C	L19
SUPER plus 5	A-line 7	W 2 CC	L11SL	W 9 CC	L19
SUPER plus 6	A-line 32	W 2 C0	L11SL	W 9 D	L17YC
SUPER plus 7	A-line 20	W 2 CS	L10SL	W 9 DC	L17YC
SUPER plus 8	DR15YS-9	W 3 A	N12C	W 9 DC0	L17YC
SUPER plus 9	DR17LDC-1	W 3 AC	N12C	W 9 DCX	LR17YC-1
SUPER plus 10	A-line 3	W 3 AS	NR12S	W 9 DTC	LR17TC
SUPER plus 11	A-line 11	W 3 CC	LR12SL	W 9 EC	K19
SUPER plus 12	A-line 19	W 3 CS	L11SL	W 9 E0	J19
SUPER plus 13	A-line 33	W 4 AC	N12C	W 9 EC0	J17
SUPER plus 14	GR17YS	W 4 AS	NR12S	W 9 F	K17Y
SUPER plus 15	LR12YS	W 4 CC	LR12C	W 9 FC	K17Y
SUPER plus 16	A-line 9	W 4 CS	LR12SL	W 10 AC	N19C
SUPER plus 17	A-line 25	W 5 AC	N14C	W 10 CC	L19
SUPER plus 18	GR14YS	W 5 AS	NR12S	W 10 EC	K19
SUPER plus 19	A-line 36	W 5 B	N12YC	W 11 E0	J19
SUPER plus 20	NR17YC	W 5 BC	N12YC	WR 3 CC	LR12SL
SUPER plus 21	A-line 10	W 5 CC	L14C	WR 4 AC	NR12C
SUPER plus 22	A-line 38	W 5 CS	LR14S	WR 4 CC	LR12C
SUPER plus 24	DR15YP	W 5 DC	L12YC	WR 5 AC	NR14C
SUPER plus 32	DR15LC-1	W 5 DC0	L12YC	WR 5 CC	LR14C
SUPER plus 34	LR17LC	W 5 DP	LR12YP	WR 5 D+	LR12YS
SUPER plus 36	DR17LDC-1	W 5 DP0	LR12YP	WR 5 DC	LR12YC
SUPER plus 38	A-line 35	W 5 DTC	LR12TC	WR 5 DC+	LR12YS
SUPER plus 40	MR14LC	W 6 AC	N14C	WR 5 DP	LR12YP
SUPER plus 44	DR17TC-1	W 6 BC	N14YC	WR 5 DS	LR12YS
SUPER plus 45	DR17YP-1	W 6 CC	L14C	WR 6 AC	NR14C
SUPER plus 46	GR15YC-1	W 6 DC	L14YC	WR 6 BC	NR14YC
SUPER plus 47	DR15LC	W 6 DC0	L14YC	WR 6 CC	LR14C
SUPER plus 49	GR15YP-1	W 6 DCX	LR14TC-1	WR 6 D+	A-line 19
SUPER plus 50	DR15YP	W 6 DP	LR14YP	WR 6 DC	LR14YC
SUPER plus 51	DOX15LE-1	W 6 DTC	LR14TC	WR 6 DC+	A-line 19
SUPER plus 52	P1	W 7 AC	N15C	WR 6 DC2	LR14YC



BOSCH	BRISK	BOSCH	BRISK	BOSNA	BRISK
WR 6 DCX	LR14TC-1	WS 5 F	P15Y	FE20	L19
WR 6 DP	LR14YP	WS 6 E	P15	FE20C	L19
WR 6 DPX	LR14YP-1	WS 6 F	P15Y	FE30	L19
WR 6 DS	LR14YS	WS 7 E	P15	FE30C	L19
WR 6 DTC	LR14TC	WS 7 F	P17Y	FE40	L19
WR 7 AC	NR15C	WS 8 E	P17	FE40C	L19
WR 7 B+	A-line 3	WS 8 F	P18Y	FE50	L17C
WR 7 BC	NR15YC	WS 9 EC	P17	FE50C	L17C
WR 7 BC+	A-line 3	WSR 5 F	PR15Y	FE55CP	L17YC
WR 7 CC	LR15C	WSR 6 E	PR15	FE55CPD	LR17TC
WR 7 CCX	LR15C-1	WSR 6 F	PR15Y	FE55P	L17YC
WR 7 D+	A-line 2	WSR 6 F200	PR15Y	FE65CP	L15YC
WR 7 D+X	A-line 10	WSR 7 F	PR17Y	FE65CPD	LR15TC
WR 7 DC (0,7mm)	LR15YC	WSR 8 E	PR17	FE65P	L15YC
WR 7 DC (0,8mm)	LR15YC	WSR 8 F	PR18Y	FE70	L17C
WR 7 DC (0,9mm)	LR15YC-9	WSR 9 EC	PR17	FE70C	L17C
WR 7 DC+	A-line 2	X 3 CC	BR10S	FE75	L15C
WR 7 DC2	LR15YC-9	X 3 CP0	BR10S	FE75C	L15C
WR 7 DCX	LR15YC-1	X 4 CC	BR12S	FE80	L14C
WR 7 DCX+	A-line 10	X 4 CS	BR12S	FE80C	L14C
WR 7 DP	LR15YP	X 5 CC	B12C	FE85CP	L14YC
WR 7 DP1X	LR15YP-1	X 5 DC	BR12YC	FE85CPD	LR14TC
WR 7 DPX	LR15YP-1	X 5 DC (0,9mm)	BR12YC-9	FE85P	L14YC
WR 7 DS	LR15YS-9	X 5 DTC	BR12YC	FE95CP	L12YC
WR 7 DTC	LR15TC	XR 2 CS	BR12S	FE95P	L12YC
WR 7 EC	KR17C	XR 5 CC	BR12S	FE100C	LR12C
WR 7 KI33S	LR15YP	XR 5 DC	BR12YC	FET55CP	G17YC
WR 7 LT+	A-line 37	Y 5 DDC	BR12YC	FET55P	G17YC
WR 7 LTC+	A-line 37	Y 6 DC	BR14YC	FET65CP	G15YC
WR 8 AC	NR17C	YR 6 KI332S	P10	FET65P	G15YC
WR 8 B+	NR17YC	YR 6 LDE	BR14YC	FET75CP	G14YC
WR 8 BC	NR17YC	YR 7 DC+	BR15YC	FET75P	G14YC
WR 8 BC+	NR17YC	YR 7 NE	QR15LC-1	FET85CP	G14YC
WR 8 CC	LR17C	YR 8 SEU	QR15LC-1	FET85P	G14YC
BOSNA	BRISK				
WR 8 D+	A-line 6	F100	N14C	FS20	K19
WR 8 D+X	A-line 38	F100C	N14C	FS30	K19
WR 8 DC (0,7mm)	LR17YC	F20	N19C	FS50	K17C
WR 8 DC (0,8mm)	LR17YC	F20C	N19C	FS50P	K17Y
WR 8 DC (0,9mm)	LR17YC-9	F35CP	N17YC	FS50CP	K17Y
WR 8 DC+	A-line 6	F35P	N17YC	FS55CP	K15YC
WR 8 DC04	LR17YC-9	F40	N19C	FS55P	K15YC
WR 8 DC4	LR17YC	F40C	N19C	FS70	K17C
WR 8 DCX	LR17YC-1	F50	N17C	FSC50	P17
WR 8 DCX+	A-line 38	F50C	N17C	FSC50C	P17
WR 8 DP	LR17YP	F55CP	N17YC	FSC50P	P18Y
WR 8 DPX	LR17YP-1	F55P	N17YC	FSC70P	P17Y
WR 8 DS	LR17YS	F65CP	N15YC	FSC75P	P15Y
WR 8 LC	LR17LC	F65P	N15YC	FSTC50	U17
WR 8 LC+	LR17LC	F70	N17C	FSTC50C	U17
WR 8 LT+	A-line 21	F70C	N17C	FSTC80	U15
WR 8 LTC+	A-line 21	F75	N15C	FSTC80C	U15
WR 9 D+	LR17YC-9	F75C	N15C	FT45CP	H19YC
WR 9 DC	LR17YC-9	F80	N14C	FT45P	H19YC
WR 9 DC+	LR17YC-9	F80C	N14C	FT55CP	HR17YC
WR 9 DCX	LR17YC-1	F85CP	N14YC	FT55P	HR17YC
WR 9 DP	LR17YP	F85P	N14YC	FT65CP	HR15YC
WR 9 DPX	LR17YP-1	F95CP	N12YC	FT65P	HR15YC
WR 9 DS	LR17YC	F95P	N12YC	FT85CP	HR14YC
WR 9 ECO	JR17	FE100	L14C	FT85P	HR14YC
WR 11 E0	JR19	FE100C	L14C	MT45CP	F17YC
WS 5 E	P15			MT45P	F17YC



BOSNA	BRISK
MT55CP	F15YC
MT55P	F15YC
MT60T	FR17C
MT65CP	F14YC
MT65P	F14YC
MT70T	FR15C
SFE55CP	D17YC
SFE55P	D17YC
SFE65CP	D15YC
SFE65CPD	DR15TC
SFE65P	D15YC
SFE85CP	D14YC
SFE85CPD	DR14TC
SFE85P	D14YC
T70	NAR15YS
T90	NAR14YC
TWE70	B14C
TWE75	B12C
TWE80	B10C
BRIGGS & STRATTON	BRISK
6093E	DR17YC
6099E	JR19
491055E	DR17YC
496018E	DR17YC
992039	JR19
992041	JR19
992300	JR19
992301	JR19
992302	JR19
992304	DR17YC
992305	DR17YC
992306	DR17YC
BS19LM	J19
BS19LMR	JR19
BSJ19LM	JR19
BS-OHV	DR17YC
BS-OHV-HT	DR17YC
BS-SV	JR19
CARLTON	BRISK
71010	U15
71015	U17
71020	P15
71025	P15Y
71030	P15
71035	P15Y
71040	P17
71045	P18Y
71050	N15C
71055	N17C
71060	K19
71065	N19C
71070	PR18Y
C75	N15C
C8A	K17C
C8S	N17C
C9	K19
C9E	J17
C10S	N19C
C11	J19
CA5E	P15
CA5Y	P15Y

CARLTON	BRISK
CA6	PR15Y
CA7E	P15
CA7S	N15C
CA7Y	P17Y
CA8E	P17
CA8Y	P18Y
CN6E	U15
CN8E	U17
LR17A	JR17
LR19A	JR19
SC92B	N17YC
SCR10G	NAR14YC
SCR11C	LR17YC
SCR12F	DR17YC
SPAR7Y	PR17Y
SPAR8E	PR17
SPCA5E	P15
SPCA5Y	P15Y
SPCA7Y	P17Y
SPCAR7Y	PR17Y
SPCA8E	P17
SPCA8Y	P18Y
SPC8S	N17C
SPCA6	PR15Y
SPC11	J19
SPLR19A	JR19
SPSCR9C	LR15YC
SPSCR11C	LR17YC
SPSCR12F	DR17YC
CHAMPION	BRISK
OE001	L15YC
OE002	DR15YC
OE003	D15YC
OE004	LR15YC
OE005	DR15YC
OE006	LR15YC
OE007	N15YC
OE008	LR14YC
OE009	G15YC
OE010	L14YC
OE011	GR15YC
OE012	LR14TC
OE013	DR17YC
OE014	DR14YC
OE015	L17YC
OE016	DR15YC
OE017	D14YC
OE018	LR14YC
OE019	DR15LDC
OE020	GR15YC
OE021	DR14TC
OE022	L15YC
OE023	D15YC
OE024	DR15YC-1
OE025	LX15LTC-1
OE026	DR14TC
OE027	LR17TC-1
OE028	LR15TC-1
OE029	A-line 25
OE030	DR14YC
OE031	RR15YC-1

CHAMPION	BRISK
OE032	DX15LTC-1
OE033	DR15YC
OE034	DR14YC
OE035	ER15YC-1
OE036	G15YC
OE037	N17C
OE038	N14YC
OE039	DR15YC-1
OE040	L14C
OE041	DR17LC
OE042	LR17YC
OE043	DR14YC
OE044	LR15TC
OE045	LR17YC
OE046	L14YC
OE047	LR15YC-1
OE048	LR15YC-1
OE049	LR17YC-1
OE050	G14YC
OE051	LR17YC
OE052	BR12YC
OE053	FR14YC
OE054	FR14YC
OE055	L17YC
OE056	DR14YC-1
OE057	D17YC
OE058	D14YC
OE059	N17YC
OE060	LOR15YC
OE061	F14YC
OE062	DR15YC-1
OE063	DR15YC-1
OE064	NR14YC
OE065	L17YC
OE066	DR15LC
OE067	G14YC
OE068	L14C
OE070	N15YC
OE071	NR14YC
OE072	G15YC
OE073	BR12YC
OE074	L17C
OE075	D12YC
OE076	DR14TC
OE077	DR14TC-1
OE078	LR14S
OE079	L15C
OE080	DR14YC-1
OE081	DR14YC-1
OE082	G12YC
OE083	BR14YC
OE084	L12YC
OE085	DR15LDC
OE086	NR15C
OE087	L12YC
OE088	DR15YC
OE089	DR15LC-1
OE090	G12YC
OE091	LR14C
OE092	AR14YS
OE093	DR15YC



CHAMPION	BRISK	CHAMPION	BRISK	CHAMPION	BRISK
OE094	DR12YC	OE181	DR15YP-1	KC8ZPYPB4	DOX15LE-1
OE095	LR14TC	OE182	DR15YP-1	L10	N15C
OE096	N17C	OE184	DR17YP	L78C	N14C
OE097	A-line 19	OE185	DR15YP	L78YC	N14YC
OE098	LR15C	OE186	BR14YC	L77JC4	N14C-1
OE099	G17YC	OE199	BR14YC	L82C	N15C
OE100	LR15TC	OE201	QR15LC-1	L82YC	N14YC
OE101	LR17YC-1	A53R	BR08S	L82YCC	N14YC
OE102	DR15YC	A57C	BR08S	L86C	N17C
OE103	BR10S	A59C	BR10S	L86CC	N17C
OE104	N14YC	A59GC	BR10S	L87YC	N15YC
OE106	L17YC	A6GC	BR14S	L87YCC	N15YC
OE107	LR14TC-1	A6HC	BR14YC	L88A	N19C
OE108	LR14C	C11YCC	D17YC	L90C	N19C
OE109	LR12YC	C53VC	DR08GS	L92YC	N17YC
OE110	DR12YC	C55	D10S	N11YC	L17YC
OE111	LR15YC	C55CX	D10S	N11YCC	L17YC
OE112	BR14S	C61	D12S	N12YC	L17YC
OE113	LR15YC-1	C61C	D12S	N12YCC	L17YC
OE114	DR17LC-1	C63CX	DOR14DS	N1C	LR12C
OE116	LR12YC	C63YC	DOR14IR	N21	L19
OE117	LR14TC-1	C6BMC	DOR14DS	N281YC	L15YC
OE118	DR14TC	C6BYC	DR14YS	N2C	L14C
OE119	DR14YC	C6BYC4	DR14TC-1	N2G	LR125L
OE121	DR17YC	C6VPYC	DR12YP	N3C	L14C
OE122	AR14YS	C6YCC	D12YC	N3G	LR14S
OE123	DR14TC	C7YC	D14YC	N4C	L15C
OE124	DR17YP-1	C7YCC	D14YC	N5C	L17C
OE125	LR125L	C9YC	D15YC	N6BYC	LR12YC
OE126	DR12YP	C9YCC	D15YC	N6YC	L12YC
OE127	DR14YC	C9YCE	D15YC	N6YCC	L12YC
OE128	DR17LC-1	C9YCX	D15YC	N7BMC	LR14TC
OE129	DR12YP	CJ11	P17	N7BYC	LR14TC
OE130	MR14LC	CJ4	P15	N7YC	L14YC
OE131	GR15YP-1	CJ6	P15	N7YCC	L14YC
OE132	BR14YC	CJ6Y	P15Y	N7YCE	L14YC
OE133	GR12YC	CJ7Y	P17Y	N9BMC	LR15TC
OE134	DR17YP	CJ8	P17	N9BYC	LR15TC
OE135	ER17YC-9	CJ8Y	P18Y	N9BYC4	LR15TC-1
OE136	DR14YP	DJ6J	U15	N9YC	L15YC
OE137	DR17YC-1	DJ7J	U15	N9YCC	L15YC
OE138	DR17YP-1	DJ7Y	U15Y	QC12YC	DR17YC
OE140	DR14YC	DJ8J	U17	QC57	DR10S
OE141	DR17YP	F7YC	F14YC	QC57C	DR10S
OE142	BR12S	G54V	AR08GS	QC59	DR12S
OE143	DR14YP	G55C	AR10S	QC59C	DR12S
OE144	DR15YP	G57C	AR10S	QC59YC	DOR10IR
OE145	DR15YP	J11C	K19	QC59YC	DOR10DS
OE146	DR14YP-1	J12Y	K17Y	QC61YC	DOR12IR
OE147	DR14YC-1	J12YC	K17Y	QC61YC	DOR12DS
OE148	ER15YC-1	J14Y	K17Y	QJ17LM	JR17
OE149	DR17YP	J17LM	J17	QJ19LM	JR19
OE151	GR17YC	J19LM	J19	QL78C	NR14C
OE154	DR17LC-1	J19LMR	JR19	QL78YC	NR14YC
OE155	FR15YC	J6	K17C	QL77JC4	NR14C-1
OE175	A-line 40	J6C	K17C	QL82C	NR15C
OE176	DOX15LE-1	J6J	K17C	QL82YC	NR14YC
OE177	DOX15LE-1	J8C	K19	QL86C	NR17C
OE178	ER15YC-1	KC11PYP	DR17YP	QL87YC	NR15YC
OE179	DR15YP-1	KC8WYP4	DR15YP-1	RA2HC	BR10YS-9
OE180	DR17YP-1	KC8ZMCC	DOX15LE-1	RA4GHC	BR12S



CHAMPION	BRISK
RA4HC	BR12YC
RA4HCX	BR12YC
RA59GC	BR10S
RA59PP	BR10S
RA6HC	BR14YC
RA7YC	BR14YC
RA8HC	BR15YC
RA8YCX4	BR14YC
RAX92C	BR10S
RAX92DC	BR10YS-9
RAX92YC	BR10YS-9
RAX94C	BR12S
RAX94YC	BR12YC
RAX96C	BR14S
RAX96YC	BR14YC
RC10DMC	DR15LDC
RC10ECC	DOX15LE-1
RC10PYC	DR17YP
RC10PYP4	DR17YP-1
RC10VTYC4	DR17TC-1
RC10WMP2	DR17YP
RC10WYP4	DR17YP-1
RC10YC	DR15YC
RC10YC4	DR15YC-1
RC10YCC	DR15YC
RC10YCC4	DR15YC-1
RC11LCC4	DR17LC-1
RC11PYPB4	DR17YP-1
RC12LC4	DR17LC-1
RC12LYC	DR17LC
RC12MC4	DR17YC-1
RC12MCC	DR17YC
RC12MCC4	DR17LC-1
RC12PYP	DR17YP
RC12YC	DR17YC
RC12YCC	DR17YC
RC12YCC4	DR17YC-1
RC6PYP	DR12YP
RC6YC	DR12YC
RC6YCC	DR12YC
RC78PYP	DR14YP
RC7BMC	DR14TC
RC7BYC	DR14TC
RC7BYC4	DR14TC-1
RC7YC	DR14YC
RC7YC4	DR14YC-1
RC7YCC	DR14YC
RC7YCC4	DR14YC-1
RC87PYC	DR15YP
RC87YCC	DR15YC
RC87YCL	DR15YC
RC89PYC	DR15YP
RC89WYP4	DR15YP-1
RC89YCC	DR15YC
RC8BYC	DR14YC
RC8DMC	DR14TC
RC8MCC	DR14YC
RC8MCC4	DR14YC-1
RC8PYCB	DR14YP
RC8PYP	DR14YP
RC8PYPB4	DR14YP-1

CHAMPION	BRISK
RC8TYC	DR14TC
RC8VTYC4	DX15LTC-1
RC8WMP2	DR15YP
RC8WYP4	DR15YP-1
RC8YC	DR14YC
RC8YC4	DR14YC-1
RC8YCC	DR14YC
RC8YCC4	DR14YC-1
RC8YCL	DR14YC
RC9BMC	DR15LDC
RC9MC4	DR15YC-1
RC9MCC	DR15LC
RC9MCC4	DR15LC-1
RC9YC	DR15YC
RC9YC4	DR15YC-1
RC9YCC	DR15YC
RC9YCC4	DR15YC-1
RCJ4	PR15
RCJ6Y	PR15Y
RCJ7Y	PR17Y
RCJ8	PR17
RCJ8Y	PR18Y
RDJ6J	UR15
RDJ7J	UR15
RDJ8J	UR17
REABMCL	MR14LC
REABMX	MR14LC
REC10PYC4	A-line 40
REC10YC4	ER15YC-1
REC14PYC	ER17YC-9
REC9MCLX	ER15YC-1
REC9YCL	ER15YC-1
RER8MC	QR15LC-1
RES9PYP4	A-line 25
RES9YCC4	RR15YC-1
RF10C	FR15C
RF11YC	FR17YC
RF7YC	FR14YC
RF7YCC	FR14YC
RF9YC	FR15YC
RG4HC	AR14YS
RG4PHP	AR14YS
RG6YC	AR12YS
RG6YCA	AR12YS
RG92C	AR10S
RG92DC	AR10S
RG94C	AR12YS
RG96C	AR14YS
RGU92C	AR10S
RGU94C	AR12YS
RJ17LM	JR17
RJ19LM	JR19
RJ6	KR17C
RJ6C	KR17C
RJ6J	KR17C
RL78C	NR14C
RL82C	NR15C
RL82YC	NR14YC
RL82YCC	NR14YC
RL86C	NR17C
RL87YC	NR15YC

CHAMPION	BRISK
RL95YC	NR17YC
RN10VTYC4	LR17TC-1
RN10YC	LR15YC
RN10YC4	LR15YC-1
RN11YC	LR17YC
RN11YC4	LR17YC-1
RN11YCC	LR17YC
RN11YCC4	LR17YC-1
RN12YC	LR17YC
RN1C	LR12C
RN2C	LR14C
RN3C	LR14C
RN4C	LR15C
RN5C	LR17C
RN6YC	LR12YC
RN7LCC	A-line 19
RN7YC	LR14YC
RN7YC4	LR14TC-1
RN7YCC	LR14YC
RN7YCC4	LR14TC-1
RN8VTYC4	LX15LTC-1
LR9LCC	LR9L5YC
RN9YC	LR15YC
RN9YC4	LR15YC-1
RN9YCC	LR15YC
RN9YCC4	LR15YC-1
RS12YC	GR17YC
RS6YCC	GR12YC
RS9PYP4	GR15YP-1
RS9YC	GR15YC
RS9YCC	GR15YC
RV12C	HR17C
RV12YC	HR17YC
RZ7C	TR14C
RZ7C	TR14S
RZ94C	NAR12YS
RZ96C	NAR14YC
RZ96C	NAR14YS
RZ98C	NAR15YS
S10YCC	G15YC
S12YC	G17YC
S59C	G12S
S6YC	G12YC
S6YCC	G12YC
S7YC	G14YC
S7YCC	G14YC
S9YC	G15YC
S9YCC	G15YC
S9YCC	G15YC
XC10YC	DR15YC
XC12YC	DR17YC
XC92PYC	DR17YP
XC92YC	DR17YC
Z6	NAR12YS
Z9Y	NAR14YC
Z9Y	NAR14YS
PL11YC	N17YC
PRL11YC	NR17YC
CHERY	BRISK
05033220AA	DR15LDC



CHEVROLET	BRISK	DAIHATSU	BRISK	DENSO	BRISK
09 146 367	DR17LDC-1	90919-01181-000	DR15YP	3066	A-line 2
93 230 927	DR17LDC-1	90919-01202-000	DR15LDC-1	3067	A-line 10
EC 229 626	DR15LDC	992-5130-2001-00	K19	3068	N15YC
CHRYSLER	BRISK	995-2021-2361-32	N14C	3070	NR15YC
A1005N02	LR15YC	999-06910-P9-002	NR15C	3076	KR17C
CITROEN = PSA	BRISK	999-06910-P9-003	NR14C	3085	L14YC
DACIA	BRISK	999-06910-P9-004	NR17YC	3088	LR14YC
60 00 539 311	NR15YC	999-06910-P9-005	NR15YC	3089	LR14TC-1
77 00 500 168	DR15LDC	999-06910-P9-006	LR17C	3110	LR17C
82 00 662 185	MR14LC	999-06910-P9-007	LR15C	3112	DR17LC-1
86 71 016 890	MR14LC	999-06910-P9-008	LR14C	3113	DR15YP
DAEWOO	BRISK	999-06910-P9-009	LR14C	3114	LR17YP-1
93 742 299	DR17LDC-1	999-06910-P9-011	LR17YC-1	3115	LR15YP-1
242 229 606	DR15LDC	999-06910-P9-012	LR15YC-1	3117	DR15YP-1
242 229 611	DR15LDC	999-06910-P9-017	A-line 10	3119	A-line 32
DAIHATSU	BRISK	999-06910-P9-020	A-line 2	3120	A-line 36
90048-51006-000	L14C	999-06910-P9-021	A-line 36	3121	A-line 11
90048-51008-000	L14C	999-06910-P9-022	A-line 36	3122	A-line 28
90048-51015-000	L15C	999-06910-P9-023	A-line 11	3123	DR17YP
90048-51020-000	N19C	999-06910-P9-024	A-line 11	3125	D15YC
90048-51022-000	N15C	999-06910-X9-001	LR17YP-1	3127	DR15YP
90048-51033-000	L17C	999-06910-X9-002	LR15YP-1	3128	DR15YP-1
90048-51034-000	L15YC	999-06910-XP-003	LR14YP	3129	A-line 32
90048-51034-010	L15YC	999-06910-X9-004	DR17YP-1	3130	A-line 36
90048-51040-000	LR15TC	999-06910-X9-005	DR15YP-1	3131	DR17LC-1
90048-51047-010	LR17LC	999-06910-X9-006	DR17YP-1	3132	DR17LC-1
90048-51048-000	LR17LC	999-06910-X9-007	DR15YP-1	3133	DR15LC-1
90048-51053-000	A-line 8	999-06910-X9-026	LR17YP	3134	DR17YP-1
90048-51054-000	A-line 9	999-06910-X9-027	LR15YP	3135	DR17LC-1
90048-51059-000	A-line 2	999-06910-X9-028	DR17YP	3137	A-line 32
90048-51069-000	A-line 4	999-06910-X9-029	DR15YP	3139	A-line 14
90048-51072-000	L17YC	999-06910-X9-030	DR14YP-1	3140	A-line 12
90048-51093-000	A-line 38	999-06910-X9-032	DR17YP	3141	DR15YP-1
90048-51096-000	LR15YC	999-06910-X9-033	DR17YP-1	3142	DR15YP-1
90048-51100-000	A-line 14	999-06910-X9-034	DR15YP	3144	A-line 11
90048-51114-000	LR17YC	999-06910-X9-035	DR15YP-1	3145	A-line 12
90048-51118-000	DR15YP-1	999-3400-6911-00	LR15YP	3156	P7
90048-51123-000	A-line 11	999-3401-6911-00	LR17YP	3157	DR15YP-1
90048-51133-000	DR15LDC	999-3405-6911-00	LR17YC-1	3158	DR14YP
90048-51136	DR15LDC	999-3406-6911-00	LR15YC-1	3161	DR17YP-1
90048-51136-000	DR15LDC	999-3407-6911-00	N17YC	3163	DR15YP-1
90048-51137	DR15LDC	999-3409-6911-00	N15YC	3165	A-line 33
90048-51137-000	DR15LDC	DENSO	BRISK	3168	DR15YP-1
90048-51144-000	DR17LDC	3004	DR17YP-1	3169	DR15LC-1
90048-51152-000	A-line 28	3005	P7	3174	DR17YP-1
90048-51155-000	DR15LDC	3006	A-line 36	3179	BR14YC
90048-51158-000	A-line 36	3009	A-line 11	3184	A-line 36
90048-51160-000	DR15LDC	3018	L17YC	3186	A-line 36
90048-51161-000	A-line 33	3020	A-line 38	3187	A-line 11
90048-51165-000	DR17LDC	3021	A-line 9	3192	A-line 34
90048-51166	DR15YP	3022	A-line 38	3194	DR17LDC-1
90048-51166-000	DR15YP	3027	A-line 8	3195	DR15LDC-1
90048-51168-000	DR15TC-1	3032	A-line 38	3196	DR15LDC
90048-51169-000	DR15TC-1	3034	N17C	3197	DR14TC
90048-51173-000	DR15YP-1	3043	L15YC	3199	A-line 38
90048-51178-000	DR15YP	3046	A-line 13	3201	A-line 38
90048-51196	BR14YC-9	3047	A-line 2	3210	A-line 9
90919-01060-000	LR17LC	3048	A-line 13	3244	P2
90919-01061-000	LR17LC	3049	A-line 13	3245	DR15YP
90919-01116-000	LR17YP-1	3057	LR15C	3255	D14YC
90919-01177-000	A-line 32	3062	A-line 4	3256	A-line 15



DENSO	BRISK
3262	DR15YP-1
3264	DR17YP-1
3273	DR14YP
3275	DR17YP-1
3285	LR17YP-1
3290	DR14YP
3291	LR15YP
3293	DR17YP
3297	P2
3299	A-line 34
3302	LR14YP
3304	DR15LDC
3305	DR15LDC
3306	LR15YP
3312	BR12YC-9
3313	BR10YS-9
3323	LR15YP-1
3324	P7
3333	A-line 28
3335	P2
3346	A-line 32
3347	DR14YC
3348	DR17LC-1
3349	A-line 32
3353	P7
3356	P7
3373	P4
3374	DR15LC-1
3377	P1
3378	P1
3379	DR14YC-1
3381	ER15YC-1
3400	P7
3403	P4
3412	P7
3413	DR17LC
3417	P3
3418	P2
3421	P3
3424	A-line 28
3427	MR14LC
3432	P1
3443	P2
3444	P11
3449	P2
4019	N17YC
4021	N14YC
4028	L12YC
4032	LR12SL
4048	L11SL
4057	L11SL
5008	FR17YC
5012	F15YC
5013	FR15YC
5016	A-line 36
5022	GR17YC
5031	G15YC
5032	GR15YC
5035	HR15YS
5040	HR14YS
5060	DR15TC

DENSO	BRISK
5061	DR15TC-1
5062	DR14TC
5064	LR17TC-1
5065	LR15TC
5066	LR14TC
5067	LR15TC
5068	A-line 25
5069	DR14TC
5070	A-line 31
5071	GR17LP-5
5301	P7
5302	P2
5303	P7
5304	P5
5344	P3
5601	P7
5602	P6
5603	P7
5604	P1
5616	DOR12YS-1
6014	J17
6035	J17
6036	P17
6039	U17
6040	U17Y
K14P-U11	A-line 36
K16PBR-S10	DR17TC-1
K16PRP11	DR17YP-1
K16PR-U	A-line 32
K16PR-U11	A-line 36
K16PR-ZU11	DR17YP-1
K16R-U	A-line 32
K16R-U11	A-line 36
K16TNR-S9	DR17LDC
K16TR-11	DR17LDC-1
K16-U	A-line 16
K16-U11	A-line 36
K20HR-U11	ER15YC-1
K20PBR	DR15TC
K20PBR-S10	DR15TC-1
K20PR-L11	A-line 11
K20PR-U	A-line 12
K20PR-U11	A-line 11
K20PR-ZU11	DR15YP-1
K20PTR-S	DR15LDC
K20R-U	A-line 28
K20R-U11	A-line 14
K20TNR-S	DR15LDC
K20TNR-S9	DR15LDC
K20TR11	DR15LDC-1
K20-U	A-line 17
K20-U11	A-line 14
K22PB	DR14TC
K22PBR-S	DR14TC
K22PR-U	A-line 33
K22PR-U11	A-line 34
KJ16CR-L11	DR17LC-1
KJ20CR-L11	DR15LC-1
KNPR4-11	A-line 34
MA14P-U	F17YC
MA16P-U	F17YC

DENSO	BRISK
MA16PR-U	FR17YC
MA17P-U	F15YC
MA20P-U	F15YC
MA20R-U	FR15C
P16R	LR17YP-1
P16R8	LR17YP
P20R8	LR15YP
PK16R11	DR17YP-1
PK16R8	DR17YP
PK20PR-P8	DR15YP
PK20PR11	DR15YP-1
PK20R11	DR15YP-1
PK20R8	DR15YP
PK20R-P8	DR15YP
PK22PR8	DR14YP
PQ16R	DR17YP-1
PQ16R8	DR17YP
PQ20R	DR15YP-1
PQ20R-P8	DR15YP
PT16VR13	A-line 25
PTJ14R15	GR17LP-5
Q16P-U11	A-line 36
Q16PR-U	A-line 32
Q16PR-U11	A-line 36
Q16R-U	A-line 32
Q16R-U11	A-line 36
Q16-U	A-line 16
Q20PR-U	A-line 28
Q20P-U	A-line 17
Q20R-U	A-line 12
Q20R-U11	A-line 11
Q20-U	A-line 17
Q20-U11	A-line 11
Q22PR-U	A-line 33
Q22P-U	A-line 33
SK16HR11	P3
SK16PR-A11	P7
SK16PR-E11	P7
SK16R11	P7
SK16R-P11	P7
SK20HR11	P3
SK20PR-A11	P2
SK20PR-A8	P4
SK20PR-B11	P2
SK20PR-B8	P4
SK20PR-F8	P4
SK20PR-L11	P2
SK20PR-L9	P4
SK20R11	P2
SK20R8	P4
SK20R-P11	P2
SKJ20DR-M11	P1
SKJ20DR-M11S	P1
SVK20R-Z11	P2
SVK20R-Z8	P4
SXU22PR9	P10
T16EPR-U	GR17YS
T16EX-U	GR17YS
T16PR-U	HR17YC
T20EPR-U	A-line 7
T20EP-U	A-line 5



DENSO	BRISK
T20EX-U	A-line 5
T20M-U	U17
T20MP-U	U17Y
T20P-U	F15YC
T20R-U	FR15C
T22EP-U	GR14YS
T22M-U	U15
TJ14R-P15	GR17LP-5
TR20	NR15C
TR22	NR14C
TR22-10	NR14C-1
TR24	N12C
U16FS-L	NAR17
U16FSR-L	NAR17
U16FSR-U	NAR17
U16FSR-UB	NAR17
U16FS-U	NAR17
U16FS-UB	NAR17
U17F	NAR17
U20FS	NAR15YS
U20FS-L	NAR15YS
U20FSR-U	NAR15YS
U20FS-U	NAR15YS
U22ESR-N	AR14YS
U22FS	NAR14YC
U22FS-GU	NAR14YS
U22FS-L	NAR14YC
U22FSR-L	NAR14YC
U22FSR-U	NAR14YS
U22FS-U	NAR14YS
U24ES-N	AR12YS
U24ESR-N	AR12YS
U24ETR	AR12YS
U24FS	NAR12YS
U24FS-L	NAR12YS
U24FSR-U	NAR12YS
U24FS-U	NAR12YS
U27ES-N	AR10S
U27ESR-N	AR10S
U27ETR	AR10S
U31ESR-N	AR08S
U31ETR	AR08S
VK24PRZ11	DOR12YS-1
W9	K19
W9LMR-US	JR19
W9MR-US	J19
W9-U	K19
W14	K19
W14E	L19
W14F	N19C
W14F-U	N19C
W14LMR-US	JR17
W14LM-U	J17
W14LM-US	J17
W14MR-U	PR17
W14M-U	P17
W14M-US	P17
W14-U	K19
W14-US	K19
W16EP-4	L17YC
W16EPB-10	LR17TC-1

DENSO	BRISK
W16EP-GU	LR17YP
W16EPR	LR17YC
W16EPR-11	LR17YC-1
W16EPR-S11	A-line 38
W16EPR-U	A-line 9
W16EPR-U10	A-line 38
W16EPR-U11	A-line 38
W16EP-U	A-line 8
W16ES-U	L17C
W16ETR-S	LR17TC
W16ET-S	LR17TC
W16EXR-U	A-line 9
W16EXR-U11	A-line 38
W16EXU	A-line 8
W16EX-U11	A-line 38
W16FPR-U	NR17YC
W16FP-U	N17YC
W16FS	N17C
W16FSR	NR17C
W16FSU	N17C
W17P	K17Y
W17PR-U	K17Y
W20EPBR-S	LR15TC
W20EPR-S11	A-line 13
W20EPR	LR15YC
W20EPR11	LR15YC-1
W20EPR-U	A-line 2
W20EPR-U10	A-line 13
W20EPR-U11	A-line 13
W20EPR-ZU11	LR15YP-1
W20EP-U	A-line 4
W20EP-ZU	LR15YP
W20ESR-U	LR15C
W20ES-U	L15C
W20EXR-U	A-line 2
W20EXR-U11	A-line 10
W20EX-U	A-line 4
W20EX-U11	A-line 10
W20FPR-U	A-line 3
W20FP-U	A-line 18
W20FSR	NR15C
W20FSR-U	NR15C
W20FS-U	N15C
W20M-US	P17
W20S-U	K17C
W20SR-U	KR17C
W22EP	L14YC
W22EP-GU	LR14YP
W22EPB	LR14TC
W22EPR-U	A-line 19
W22EP-U	L14YC
W22ES	L14C
W22ESR	LR14C
W22ESR-U	LR14S
W22ES-U	LR14S
W22ES-ZU	LR14YS
W22FP	N14YC
W22FPR-U	NR14YC
W22FP-U	N14YC
W22FS	N14C
W22FS-GU	NR14S

DENSO	BRISK
W22FSR	NR14C
W22FS-U	NR14S
W22FS-ZU	NR14S
W22M	P15
W22MU	P15
W22MUS	P15
W22MP-U	P15Y
W22MP-US	P15Y
W22M-U	P15
W22M-US	P15
W24EP	L12YC
W24EPR-U	LR12YS
W24EP-U	LR12YS
W24ES	LR12C
W24ES-GU	LR12SL
W24ESR	LR12C
W24ESR-U	LR12SL
W24ES-U	LR12SL
W24ES-V	LR12SL
W24ES-ZU	LR12SL
W24FP-U	N12YC
W24FSR	NR12S
W24FS-U	NR12S
W24FS-ZU	NR12S
W25EN	LR12SL
W27EMR-C	LR11S
W27EN	L11SL
W27ES	L11SL
W27ES-GU	L11SL
W27ESR	LR11SL
W27ES-U	L11SL
W27ES-V	L11SL
W27ES-ZU	L11SL
W27FC	N10S
W27F5	N11S
W29ES-GU	L11SL
W29ES-ZU	L11SL
W31EN	L10SL
W31ES	L10SL
W31ES-GU	L10SL
W31ES-U	L10SL
W31ES-ZU	L10SL
W31FS	N10S
W31FS-GU	N10S
W31FS-ZU	N10S
WA20M	U17
WA20M-U	U17
WA22M	U15
WA22M-U	U15
X22EPR-U9	BR14YC-9
X22EP-U9	BR14YC-9
X22ES-GU	BR14S
X22ESR-U	BR14S
X22ES-U	B14C
X24EPR-U9	BR12YC-9
X24EP-U9	BR12YC-9
X24ES-GU	BR12S
X24ESR-U	BR12S
X24ES-U	B12C
X27EPR-U9	BR10YS-9
X27EP-U9	BR10YS-9



DENSO	BRISK
X27ESR-U	BR10S
X27ES-U	B10C
XE20HR-U9	MR14LC
XU20EPR-U	BR15YC
XU20EP-U	BR15YC
XU22EPR-U	BR14YC
XU22EP-U	BR14YC
XU22HR9	QR15LC-1
XU24EPR-U	BR12YC
XU24EPR-ZU	BR12YP
XU24EP-U	BR12YC
XU24EP-ZU	BR12YP
EAZS APS	BRISK
A11	N19C
A14B-2	N17YC
A17B	N15YC
A17DB	L15YC
A17DB-10	L15YC
A17DBM	L15YC
A17DBP	LR15YC
A17DBPM 0,7	LR15YC
A17DBPM 1,0	LR15YC-1
A20D	L14C
A23-2	N14C
A23B	N14YC
AY17DBPM	DR15YC-1
ENGELS	BRISK
A11	N19C
A11P	NR17C
A14B	N17YC
A14B-2	N17YC
A14BM	N17YC
A14BP	NR17YC
A14DB	L17YC
A14DBP	LR17YC
A14DBPM	LR17YC
A14DBPM 1,0	LR17YC-1
A17B	N15YC
A17DB	L15YC
A17DB-10	L15YC
A17DBM	L15YC
A17DBP	LR15YC
A17DBPM 0,7	LR15YC
A17DBPM 1,0	LR15YC-1
A20D	L14C
A23-2	N14C
A23B	N14YC
AY14DBPM	DR17YC
AY17DBPM	DR15YC-1
T17DBPM 0,7	LR15TC
T17DBPM 1,0	LR15TC-1
TY17DBPM	DR15TC-1
LPG 1	NR15S
LPG 2	LR15YS
LPG 3	NR15S
LPG 4	LR15YS
LPG 5	LR15YS-9
LPG 6	DR15YS-9
ENKER (BOSNA SUPER)	BRISK
F100	N14C
F100C	N14C

ENKER (BOSNA SUPER)	BRISK
F20	N19C
F20C	N19C
F35CP	N17YC
F35P	N17YC
F40	N19C
F40C	N19C
F50	N17C
F50C	N17C
F55CP	N17YC
F55P	N17YC
F65CP	N15YC
F65P	N15YC
F70	N17C
F70C	N17C
F75	N15C
F75C	N15C
F80	N14C
F80C	N14C
F85CP	N14YC
F85P	N14YC
F95CP	N12YC
F95P	N12YC
FE100	L14C
FE100C	L14C
FE20	L19
FE20C	L19
FE30	L19
FE30C	L19
FE40	L19
FE40C	L19
FE50	L17C
FE50C	L17C
FE55CP	L17YC
FE55CPD	LR17TC
FE55P	L17YC
FE65CP	L15YC
FE65CPD	LR15TC
FE65P	L15YC
FE70	L17C
FE70C	L17C
FE75	L15C
FE75C	L15C
FE80	L14C
FE80C	L14C
FE85CP	L14YC
FE85CPD	LR14TC
FE85P	L14YC
FE95CP	L12YC
FE95P	L12YC
FE100C	LR12C
FET55CP	G17YC
FET55P	G17YC
FET65CP	G15YC
FET65P	G15YC
FET75CP	G14YC
FET75P	G14YC
FET85CP	G14YC
FET85P	G14YC
FS20	K19
FS30	K19
FS50	K17C

ENKER (BOSNA SUPER)	BRISK
FS50P	K17Y
FS50CP	K17Y
FS55CP	K15YC
FS55P	K15YC
FS70	K17C
FSC50	P17
FSC50C	P17
FSC50P	P18Y
FSC70P	P17Y
FSC75P	P15Y
FSTC50	U17
FSTC50C	U17
FSTC80	U15
FSTC80C	U15
FT45CP	H19YC
FT45P	H19YC
FT55CP	HR17YC
FT55P	HR17YC
FT65CP	HR15YC
FT65P	HR15YC
FT85CP	HR14YC
FT85P	HR14YC
MT45CP	F17YC
MT45P	F17YC
MT55CP	F15YC
MT55P	F15YC
MT60T	FR17C
MT65CP	F14YC
MT65P	F14YC
MT70T	FR15C
SFE55CP	D17YC
SFE55P	D17YC
SFE65CP	D15YC
SFE65CPD	DR15TC
SFE65P	D15YC
SFE85CP	D14YC
SFE85CPD	DR14TC
SFE85P	D14YC
T70	NAR15YS
T90	NAR14YC
TWE70	B14C
TWE75	B12C
TWE80	B10C
EVINRUDE	BRISK
204470091	LR14C
278000237	LR14C
278000608	LR14C
278000609	LR12C
MCBR10EG	LR10SL
MCBR8EG	LR12SL
MCBR8HS	NR14C
MCBR9EG	LR11SL
MCBR9ES	LR12C
EYQUEM	BRISK
D800L	B14C
200	N19C
406	N15YC
502	N17C
705S	N15YC
750LS	L15YC
755LJS	G15YC



EYQUEM	BRISK
755LS	L15YC
755SX	N14YC
755X	N14C
800LJS	G14YC
800LS	L14YC
803LJS	G14YC
850	N14C
C32	N17C
C32S	N17YC
C42	N15C
C42S	N15YC
C52LJS	G17YC
C52LS	L17YC
C52LS3X	LR17TC
C62	N14C
C62LJS	G15YC
C62LS	L15YC
C62LS3X	LR15TC
C62S	N14YC
C72	N14C
C72L	L14C
C72LJS	G14YC
C72LS	L14YC
C72LS3X	LR14TC
C82	N12C
C82LJS	G12YC
C82LS	L14YC
C82LS3X	LR12TC
C92LS	L12YC
D1000L	B10C
D1050L	B10C
D800L MOTO	B14C
D900L	B12C
FC42LS	D17YC
FC52LS	D17YC
FC58LS	D15YC
FC62LS	D14YC
FC82LS3	DR14TC-1
FN58LZKFR	DOX15LE-1
K300JS	F17YC
K350JS	F17YC
K450JS	F17YC
K550JS	F15YC
KC52JS	F17YC
KC62JS	F15YC
RC42S	NR15YC
R500CT	P17
R700CT	P15
RC52LJS	GR17YC
RC52LJS5	GR17YC-1
RC52LS	LR17YC
RC52LS5	LR17YC-1
RC52LZ3EX	LR17TC-1
RC58LZ3EX	LR15TC-1
RC58LZ3EX	LX15LTC-1
RC62HJS6	RR15YC-1
RC62HJSP	A-line 25
RC62LJS	GR15YC
RC62LJS5	GR15YC-1
RC62LS	LR15YC
RC62LS5	LR15YC-1

EYQUEM	BRISK
RC62S	NR14YC
RC72	NR14C
RC72L	LR14C
RC72LJS	GR14YC
RC82	NR14C
RC82L	LR12C
RC82LS	LR14YC
RC82LS5	LR14TC-1
RFC42LS	DR17YC
RFC42LS2E	DR17LDC
RFC42LZ2E	DR17LDC-1
RFC52JS	FR17YC
RFC52LS	DR17YC
RFC52LS5	DR17YC-1
RFC52LZDP	DR17YP
RFC52LZDP5	DR17YP-1
RFC58HZEDP5	A-line 40
RFC58LS	DR15YC
RFC58LS5	DR15YC-1
RFC58LZ2	DR15LDC-1
RFC58LZ2E	DR15LDC
RFC58LZDP	DR15YP
RFC58LZP	DR15YP-1
RFC62LS	DR14YC
RFC62LS3	DR15TC-1
RFC62LS3X	DR15TC
RFC62LZ3EX	DX15LTC-1
RFC82LS	DR14YC
RFC82LS5	DR14YC-1
RFN52LZ	DR15YC-9
RFN58HZ	ER15YC-1
RFN62LZ	DOX15LE-1
RFN62LZDP5	DOX15LE-1
RKC62JS	FR15YC
RTC68	NAR15YS
RTC72	NAR14YC
RTC72	NAR14YS
RTC72L	AR14YS
RWC52HSK	MR14LC
RZC58LS	BR15YC
FEBI BILSTEIN	BRISK
FBR10WC1	BR12YC
FBR12WC1	BR14YC
FD12WC1	D14YC
FD13WC1	D15YC
FD15WC1	D17YC
FDR10WC1	DR12YC
FDR12WC1	DR14YC
FDR13MKC2	DR15LDC
FDR13UC3	DR15TC
FDR13UC3A	DR15TC-1
FDR13WC1	DR15YC
FDR13WC1A	DR15YC-1
FDR13WPP1	DR15YP
FDR13WPP1A	DR15YP-1
FDR15MKC2	DR17LDC
FDR15MKC2A	DR17LDC-1
FDR15UC3	DR17TC
FDR15UC3A	DR17TC-1
FDR15WC1	DR17YC
FDR15WC1A	DR17YC-1

FEBI BILSTEIN	BRISK
FDR15WPP1A	DR17YP-1
FDX13MU3A	DX15LTC-1
FER13WC1A	ER15YC-1
FG13WC1	G15YC
FG15WC1	G17YC
FGR13WC1	GR15YC
FL12WC1	L14YC
FL13WC1	L15YC
FL15WC1	L17YC
FL15WC1A	LR17YC-1
FLR13UC3	LR15TC
FLR13WC1	LR15YC
FLR15UC3	LR17TC
FLR15UC3A	LR17TC-1
FLR15WC1	LR17YC
FLX13MU3A	LX15LTC-1
FRR13WC1A	RR15YC-1
FIAT	BRISK
1 L 4 JR	LR15YC
43 461 96	LR15YC
43 467 96	LR15YC
43 594 24	LR15YC
43 617 99	NR15YC
43 618 00	NR15YC
43 781 07	NR15YC
44 015 50	LR15YC
46 144 731	BR12YC-9
46 229 251	L15YC
46 417 010	A-line 28
46 463 801	DR15LDC
46 472 021	DR15LDC
46 472 0211	DR15LDC
46 475 164	DR14TC
46 480 309	DR17LDC-1
46 521 530	AR14YS
46 531 917	BR12YP
55 188 857	BR14YC-9
55 190 788	BR14YC-9
55 190 7880	BR14YC-9
58 820 87	NR15YC
58 945 85	LR14YC
58 945 86	A-line 28
58 945 87	LR15YC
58 945 88	DR14YC
58 968 24	DR15LDC
59 840 36	LR15YC
60 504 563	L15YC
60 512 848	DR15TC
60 512 929	L14C
60 569 957	DR15YP
60 579 903	DR15YP
60 597 490	D14YC
60 800 325	LR14YC
60 806 024	LR15TC
60 810 689	DR15YP
71 711 638	A-line 28
71 711 639	LR15YC
71 711 640	LR15YC
71 711 806	LR15YC
71 711 808	A-line 28
75 465 19	A-line 28



FIAT	BRISK
75 544 36	LR14YC
75 544 42	L15YC
75 544 44	LR15YC
75 544 45	N15YC
75 544 47	DR15YP
75 544 51	LR15YC
75 654 76	LR14C
76 866 43	LR15TC
77 603 81	LR14YC
77 603 82	LR15YC
77 603 83	A-line 28
77 603 84	DR14YC
77 692 43	DR15TC
77 724 53	A-line 28
77 725 15	LR14YC
79 102 472 04	GR15YC
7 FYSR	LR14YC
7 FYSSR	LR14YC
7 GBYSR 4	DR14TC
7 GYSSR	DR14YC
96 147 386 80	DR15LDC
96 184 945 80	DR17LDC
96 185 718 80	DR15LDC
96 185 788 0	DR15LDC
96 196 245 80	DR17LDC
96 265 754 80	DR15LDC
96 280 002 80	DR15LDC
9 FYSR	LR15YC
9 FYSSR	LR15YC
9 GYSSR	A-line 28
V 4NS	NR15YC
FORD	BRISK
1077002	A-line 25
1120170	DOX15LE-1
1202935	A-line 25
1204572	GR15YP-1
1219309	RR15YC-1
1255464	RR15YC-1
1523608	LR15YC
2000077	DR15YP
5099742	LR15YC
5099768	LR15YC
5099884	LR15YC
78TF12405BA	LR15YC
AGPS44F	DOX15LE-1
AYFS22FE1J	A-line 25
AYFS32CJ	RR15YC-1
V92HF12405BA	DR15YP
FUJI	BRISK
065-01400-10	K19
065-01400-20	N19C
065-01400-31	N15C
065-01400-41	N14C
065-01400-50	L14C
065-01400-60	N15C
065-01400-80	K19
065-01400-90	N14C
065-01401-00	L15C
065-01401-10	N19C
065-01401-30	L14C
065-01401-40	L14C

FUJI	BRISK
065-01401-50	NR15C
065-01401-60	LR12C
065-01401-80	NR14C
065-01402-10	N15YC
065-01402-20	L10SL
065-01402-30	L17YC
065-01402-40	LR14C
065-01402-50	LR12C
065-01402-60	N17YC
065-01402-80	LR17YC
065-01403-00	L15YC
065-01403-70	P17
065-01403-80	PR17
065-01404-20	NR15YC
065-01404-30	PR17Y
065-01404-60	P17
065-01404-70	PR17
065-01404-70	PR17
065-01405-00	N11S
065-01405-10	NR15C
932-05410-00	L17C
982-05486-00	L15C
FUJI HEAVY INDUSTRIES BRISK	
22401 AA000	LR17YC-1
22401 AA010	LR15YC-1
22401 AA020	L15YC
22401 AA120	LR15YC-1
22401 AA220	LR15YC
22401 AA310	A-line 14
22401 AA370	DR15YP-1
22401 AA400	DR15YP
22401 AA480	LR17YC-1
22401 AA500	DR15YP-1
22401 AA510	DR15YP
22401 AA520	DR15YP-1
22401 AA530	DR15YP
22401 AA570	DR17YP-1
22401 AA580	A-line 40
22401 AA600	DR14YP
22401 KA010	A-line 11
22401 KA080	A-line 28
22401 KA100	A-line 12
22401 KA210	A-line 36
22401 KA240	BR14YC
22401 KA310	BR12YC
22401 KA320	BR12YP
22401 KA440	A-line 32
42054 3200	L17YC
49001 0033	LR17YC
49001 0043	A-line 8
49001 0053	A-line 4
GATOR	BRISK
77-300-1	P17Y
77-301-1	J19
77-302-1	P17
77-303-1	DR17YC
77-304-1	U17
77-305-1	JR19
77-306-1	PR17
77-307-1	PR15Y
77-308-1	P15
77-309-1	P18Y

GATOR	BRISK
77-310-1	L17YC
77-311-1	P15Y
77-312-1	LR15YC
77-313-1	J17
77-314-1	LR17YC-1
77-315-1	L15YC
77-316-1	U15
77-317-1	K19
77-318-1	U17Y
77-319-1	PR18Y
77-320-1	NR17YC
77-321-1	N17C
77-323-1	L14C
77-324-1	PR17Y
77-325-1	NR15YC
77-032	LR14C
77-012	U15
GMC	BRISK
96 307 729	DR15LDC
GUTBROD	BRISK
000.80.071	N15C
000.81.345	J17
090.33.668	N19C
090.50.572	N19C
090.50.805	LR15YC
092.05.406	JR19
092.05.900	K17C
092.13.609	JR17
092.25.081	L17YC
092.32.278	DR17YC
092.38.072	LR17YC
092.38.467	P17
092.40.182	GR17YC
HARLEY-DAVIDSON	BRISK
10R12A	BR10YS-9
3-4	K17Y
4-5	N14YC
4R5	NR14C-1
5	K17C
5A6	A-line 8
5R6	A-line 9
5R6A	A-line 38
6R12	BR14YC-9
8	L10SL
HONDA	BRISK
12290-PNE-0030	DOX15LE-1
31915-Z0H-0030	TR17
31915-Z0H-0030	TR17C
31915-Z0H-0031	TR17
31915-Z0H-0031	TR17C
31915-Z0H-801	TR17
31915-Z0H-801	TR17C
31916-Z0H-003	TR15C
31916-Z0H-801	TR15C
98056-54718	NAR17
98056-55713	NAR17
98056-55717	NAR17
98056-55718	NAR17
98056-55770	NAR17
98056-55777	NAR17
98056-56713	NAR15YS



HONDA	BRISK
98056-56716	NAR15Y5
98056-56717	NAR15Y5
98056-56718	NAR15Y5
98056-57713	NAR14YC
98056-57716	NAR14YC
98056-57717	NAR14YC
98056-57718	NAR14YC
98056-58713	NAR12Y5
98056-58716	NAR12Y5
98056-58717	NAR12Y5
98056-58718	NAR12Y5
98059-59910	AR10S
98059-59916	AR10S
98069-38716	BR12S
98069-56911	BR15YC
98069-5697Q	BR15YC
98069-57716	BR14S
98069-57717	B14C
98069-57719	BR14S
98069-5771P	BR14S
98069-57726	BR14S
98069-57911	BR14YC-9
98069-57916	BR14YC-9
98069-5797Q	BR14YC
98069-58716	BR12S
98069-58717	B12C
98069-58719	BR12S
98069-5871P	BR12S
98069-58911	BR12YC-9
98069-58912	BR12YP
98069-58916	BR12YC-9
98069-5891F	BR12YP
98069-59717	B10C
98069-59911	BR10YS-9
98069-59912	BR10YS-9
98069-59916	BR10YS-9
98069-5991F	BR10YS-9
98073-54710	K19
98073-54740	P17
98073-54744	PR17
98073-56740	P17
98073-56741	P17Y
98073-56744	PR17
98076-54710	N19C
98076-54770	N19C
98076-55711	N17YC
98076-55716	NR17C
98076-55717	NR17YC
98076-55719	N17YC
98076-55747	NR17YC
98076-5671G	NR15C
98076-5691G	NR15C
98076-56710	N15C
98076-56711	N15C
98076-56713	N15YC
98076-56715	NR15YC
98076-56716	NR15C
98076-56717	NR15YC
98076-56719	N15YC
98076-56740	N15C
98076-56741	N15C

HONDA	BRISK
98076-56747	NR15YC
98076-56917	NR15YC
98076-57710	N14C
98076-57711	N14YC
98076-57716	NR14C
98076-57717	NR14YC
98076-57719	N14YC
98076-57740	N14C
98076-5871G	NR14C
98076-5891G	NR14C
98076-58710	N14C
98076-58711	N12YC
98076-58713	N12YC
98076-58715	NR12YC
98076-58716	NR14C
98076-58717	NR12YC
98076-58719	N12YC
98076-58740	N14C
98076-58747	NR12YC
98076-59710	N12C
98076-59716	NR12C
98076-59740	N12C
98079-55140	A-line 36
98079-55141	A-line 38
98079-55144	A-line 38
98079-55145	A-line 38
98079-55146	A-line 38
98079-55147	A-line 36
98079-55148	A-line 36
98079-55149	A-line 36
98079-5514A	A-line 11
98079-5514B	A-line 36
98079-5514E	A-line 36
98079-5514F	DR17YP-1
98079-5514G	DR17LC-1
98079-5514H	DR17YP-1
98079-5514J	A-line 36
98079-5514N	DOX15LE-1
98079-5514P	DR17LC-1
98079-5515G	DR15LC-1
98079-55810	L17C
98079-55811	L17YC
98079-55816	LR17C
98079-55817	LR17YC
98079-55840	L17C
98079-55841	L17YC
98079-55844	LR17YP
98079-55846	LR17YC
98079-55847	LR17C
98079-5585V	A-line 15
98079-55871	LR15YC
98079-5587G	DR17LC
98079-5587V	A-line 6
98079-55881	LR15YC
98079-55941	A-line 8
98079-55946	A-line 9
98079-56140	A-line 11
98079-56144	LR15YC-1
98079-56145	LR15YC-1
98079-56146	A-line 13
98079-56147	A-line 11

HONDA	BRISK
98079-56148	A-line 11
98079-56149	A-line 11
98079-5614B	A-line 11
98079-5614E	A-line 11
98079-5614F	DR15YP-1
98079-5614G	DR15LC-1
98079-5614H	DR15YP-1
98079-5614J	A-line 11
98079-5614N	DOX15LE-1
98079-5614P	DR15LC-1
98079-5615G	DR15LC-1
98079-5615N	DOX15LE-1
98079-56175	A-line 10
98079-56175	DR15YP-1
98079-5617T	DR15YP-1
98079-56810	L15C
98079-56811	L15YC
98079-56817	LR15C
98079-56832	LR15YC
98079-56840	L15C
98079-56841	L15YC
98079-56844	LR15YP
98079-56846	LR15YC
98079-56846-02	LR15YC
98079-56847	LR15C
98079-56941	A-line 4
98079-56946	A-line 2
98079-57140	A-line 34
98079-57144	LR14TC-1
98079-57145	LR14TC-1
98079-57146	LR14TC-1
98079-57147	A-line 34
98079-57148	A-line 34
98079-57149	A-line 34
98079-5714B	A-line 34
98079-5714E	A-line 34
98079-5714F	DR14YP-1
98079-5714H	DR14YP-1
98079-5714J	A-line 34
98079-5715H	DR14YP-1
98079-5787G	DR14YP
98079-571BH	DR14YP-1
98079-57614	LR14S
98079-57810	L14C
98079-57811	L14YC
98079-57816	LR14C
98079-57840	L14C
98079-57841	L14YC
98079-57846	LR14YC
98079-57847	LR14C
98079-57876	LR14C
98079-57877	LR14C
98079-5787T	DR14YP
98079-57941	A-line 19
98079-57946	A-line 19
98079-58644	L11SL
98079-58646	LR12SL
98079-58648	LR12SL
98079-58649	LR12SL
98079-58678	L11SL
98079-58679	LR12SL



HONDA	BRISK
98079-58810	L14C
98079-58812	L11SL
98079-58816	LR14C
98079-58819	LR12SL
98079-58840	L14C
98079-58842	LR12SL
98079-58846	LR14C
98079-58847	LR12YC
98079-58870	L14C
98079-58872	LR12SL
98079-58876	LR14C
98079-59644	L11SL
98079-59646	LR11SL
98079-59648	L11SL
98079-59649	LR11SL
98079-59678	L11SL
98079-59679	LR11SL
98079-59810	LR12C
98079-59811	LR12C
98079-59816	LR12C
98079-59819	LR11SL
98079-59840	LR12C
98079-59842	L11SL
98079-59845	LR11S
98079-59847	LR12C
98079-59870	LR12C
98079-59872	L11SL
98079-59875	LR11S
98079-59876	LR12C
98079-60616	LR10SL
98079-60646	LR10SL
98079-60648	L10SL
98079-60649	LR10SL
98079-60676	LR10SL
98079-60678	L10SL
98079-60679	LR10SL
98079-60817	LR11SL
98079-60819	LR10SL
98079-60842	L10SL
98079-60845	LR10S
98079-60872	L10SL
98079-60875	LR10S
9807B-5617P	DOX15LE-1
9807B-561BP	DOX15LE-1
98179-56841	L15YC
HUSQVARNA	BRISK
HQT-1	PR17YC
HQT-2	PR15YC
HQT-3	TR15C
HQT-4	SR15C
HQT-5	TR14C
HQT-5	TR14S
HYUNDAI	BRISK
09482-00538	P7
18811-08061	LR15YC
18811-11051	LR17YC-1
18811-11061	LR15YC-1
18814-08061	DR15YC
18814-08062	DR15YC
18814-11051	DR17YC-1
18814-25000	P7

HYUNDAI	BRISK
18822-08091	LR15YC-1
18829-11050	DR17YC-1
18854-10080	QR15LC-1
18855-10060	QR15LC-1
ISOLATOR	BRISK
6B	N15YC
7A	N15C
7B	N15YC
7D	L15YC
A5D	G14YC
A7D	G15YC
FM14-145/2	L17YC
FM14-175/2	L15YC
FM14-200/2	L15YC
FM14-225/2	L14YC
M14-145	N17C
M14-175	N15C
M14-175/2	L15C
M14-225	N14C
M14-240	N14C
M14-260	N12C
M14-95	N19C
PM14-225	N14YC
U7D	D15YC
U8D	D17YC
ZM14-260	N12C
ISUZU	BRISK
5-81380001-0	LR17YC
5-81380003-0	LR17YP
5-81380004-0	LR15YP
5-81380012-0	A-line 6
5-81380013-0	A-line 2
5-86003122-0	DR17LC-1
5-86003124-0	DR15LC-1
5-86007635-0	A-line 36
5-86007636-0	DR17LC-1
5-86007639-0	DR15LC-1
5-86103380-0	LR17YC-1
5-86103381-0	LR15YC-1
5-86103382-0	LR14TC-1
5-86103385-0	DR17YP-1
5-86103386-0	DR15YP-1
5-86103387-0	DR14YP-1
5-86103389-0	DR17YP-1
5-86103390-0	LR15YP-1
5-86103391-0	LR14YP-1
5-86121749-0	DR17YC-1
5-86121750-0	DR15YC-1
5-86123951-0	A-line 36
5-86123952-0	A-line 14
5-86123953-0	A-line 34
8-94120560-0	LR17YC-1
8-94217232-0	LR15YC-1
8-94219943-0	LR15YC
8-94235966-0	LR17YC-1
8-94241059-0	LR15YC-1
8-94328372-0	A-line 11
8-94328373-0	A-line 34
8-97012928-0	A-line 12
9-82513103-0	L15YC
9-82513105-0	L15C

ISUZU	BRISK
9-82513106-0	L17YC
9-82513107-0	L17C
9-82513113-0	L14C
ITALJET	BRISK
94004	NR14C
94015	BR12S
94025	NR12C
94029	LR12C
94032	AR14YS
JAGUAR	BRISK
AJ84575 IFR5N10	P7
C2A1535 IFR5N10	P7
EAC8554 BR7EFS	GR14S
EBC004021 BR7EF	GR14S
EBC4021 BR7EF	GR14S
JAPCAR	BRISK
123762	L17YC
123770	L15YC
123778	LR17YC
123789	LR15YC
123801	LR14YC
123825	LR17YC-1
123834	LR15YC-1
123887	LR17YC
123899	LR15YC
123908	LR14YC
123932	LR17YC-1
123940	LR15YC-1
123993	LR14TC-1
123996	LR14C
124040	LR14TC-1
124144	LR15YC-1
166573	LR15YC
167605	DR15YP-1
170006	LR15YC-1
172988	LR17YC
172994	LR15YP-1
172996	LR15YP
172998	LR15YP-1
173939	A-line 14
177391	A-line 14
207417	DR15YP-1
239214	DR17YP-1
277200	A-line 36
277201	A-line 36
279427	DR17YP-1
JENN FENG	BRISK
9111-310002	UR17Y
9295-310002	UR17Y
9295-310502	TR14C
9295-310502	TR14S
9295-320001	UR17
9295-331501	PR15Y
JOHNSON	BRISK
204470091	LR14C
278000237	LR14C
278000608	LR14C
278000609	LR14C
MCBR10EG	LR10SL
MCBR8EG	LR12SL
MCBR8HS	NR14C



JOHNSON	BRISK
MCBR9EG	LR11SL
MCBR9ES	LR12C
K & N	BRISK
XP422	DR15YP-1
KAWASAKI	BRISK
92070-0020	AR12YS
92070-2077	LR15YC
920700001	N14C
920700019	AR12YS
920700020	AR12YS
920700022	AR14YS
920700029	AR12YS
920700007	N15C
920700014	L15C
920700015	L14C
920700019	L15C
920700036	N12C
920700037	L14C
920700053	L14C
920700054	LR12C
920701002	L14C
920701011	B12C
920701014	L12YC
920701014B	L12YC
920701019	BR12S
920701021	LR14C
920701024	L15YC
920701025	LR15YC
920701026	L14YC
920701027	LR14YC
920701034	B10C
920701044	LR12YC
920701063	LR11SL
920701064	LR12SL
920701065	BR12YC-9
920701066	BR12YC-9
920701067	BR10YS-9
920701068	BR10YS-9
920701107	NAR14YC
920701109	LR12C
920701113	BR14S
920701114	NAR15YS
920701114C	NAR15YS
920701116	BR12S
920701124	BR14YC-9
920701125	BR14YC-9
920701131	NAR12YS
920701133	LR10SL
920701138	BR15YC
920701140C	L12YC
920701141C	N14YC
920701142	AR10S
920701143	AR10S
920701145	AR10S
920701152	L14YC
920701152C	L14YC
920701153	NAR15YS
920701154	NAR14YC
920701155	NAR12YS
920701157	LR12C
920701158	AR12YS

KAWASAKI	BRISK
E920701165	BR14S
E920701168	AR12YS
E920701168B	AR12YS
E920701169	AR12YS
E920701169B	AR12YS
E920701173	LR11SL
E920701189	BR10S
E920701199	BR12S
E920701202B	N14YC
E920701209	AR14YS
E920701210	LR12C
E920701218	NAR12YS
E920701221	L10SL
E920701222	LR12SL
E920701223	L11SL
E920701224	L11SL
E920701227	L11SL
E920701228	LR11SL
E920701230	LR12SL
E920701231	LR12SL
E920701253C	L11SL
E920701263	N12YC
E920701264	AR10S
E920701266	AR10S
E920702051	P17
E920702055	JR19
E920702060	PR17
E920702066	P15
E920702072	PR17
E920702074	PR15
E920702078	LR14C
E920702090	N19C
E920702098	JR17
E920702102	P15Y
E920702106	PR18Y
E920702107	PR15Y
E920702108	PR18Y
E920702109	P18Y
E920702116	N15C
E920702117	NR15C
E920702118	LR17YP
E920703701	LR14C
E920703702	LR14C
J4520IU22	AR14YS
J4520IU24	AR12YS
J4520IW16	LR17YP-1
J4520IW20	LR15YP-1
J4520IW22	LR14YP
J4520IW24	LR12SL
J4520IW27	LR11SL
J4520IW31	LR10SL
J4520IWF22	NR14S
J4520IWF24	NR12S
J4520IX24	BR12S
J4520IX24B	BR12YP
J4520IX27	BR10S
J4520IX27B	BR10YS-9
J4520TR24	NR14C
J4520U20FSRU	NAR15YS
J4520U22ESRN	AR14YS
J4520U22FSL	NAR14YC

KAWASAKI	BRISK
J4520U22FSRU	NAR14YC
J4520U24ESRN	AR12YS
J4520U27ESRN	AR10S
J4520U27ETR	AR10S
J4520W20FPRU	NR15YC
J4520W22FPRU	NR14YC
J4520W24ESRU	LR12C
J4520W24FSU10	N14C-1
J4520W27ESRU	LR11SL
J4520W27ESU	LR11SL
J4520W31ESRU	LR10SL
J4520X20EPRU9	BR15YC
J4520X22EPRU9	BR14YC-9
J4520X24EPRU9	BR12YC-9
J4520X24EPU9	BR12YC-9
J4520X24ESRU	BR12S
J4520X24ESU	B12C
J4520X27EPRU9	BR10YS-9
KIA	BRISK
00259 18 110	L15YC
0K558 18 110	DR15YP-1
0K01A 18 110	A-line 32
0K01C 18 110	A-line 14
0K2AA 18 110	A-line 28
18814-11051	DR17YC-1
18814-11061	DR15YC-1
18854-09080	QR15LC-1
18854-10080	QR15LC-1
18855-10060	QR15LC-1
KIORITZ	BRISK
159010-00130	K17C
159010-00830	P15
159010-01820	K19
159010-03520	N17C
159010-04120	N15C
159010-10050	N19C
159026-00830	P15
159026-12330	P17Y
A425213-0010	P17
A425300-0210	P17Y
A425303-0010	P15Y
A425306-0310	PR17
A425306-0311	PR17
A425306-0400	PR18Y
A425306-0401	PR18Y
A425307-0010	P18Y
A425308-0010	P17
A425309-0010	P15Y
A425309-0210	PR15Y
A425309-0211	PR15Y
A425309-0301	PR15Y
A425312-0010	P15Y
A425314-0010	P15Y
KLK	BRISK
F100	N14C
F20	N19C
F220	N12C
F55P	N17YC
F65P	N15YC
F70	N17C
F75	N15C



KLG	BRISK
F80	N14C
F85P	N14YC
F95P	N12YC
FE100	L14C
FE125P	L15YC
FE135P	L14YC
FE145P	L12YC
FE155P	L12YC
FE220	LR12C
FE30	L19
FE45P	L17YC
FE50	L17C
FE55P	L17YC
FE65P	L15YC
FE70	L17C
FE75	L15C
FE80	L14C
FE85P	L14YC
FE95P	L12YC
FS20	K19
FS30	K19
FS50	K17C
FS55P	K15YC
FS70	K17C
FT55P	HR17YC
FT65P	HR15YC
FT85P	HR14YC
GT4S	K17Y
GT4T	F17YC
GT5	N17YC
GT5L	L17YC
GT5T	F17YC
GT6	N15YC
GT6L	L15YC
GT6T	F15YC
GT7	N14YC
GT7L	L14YC
GT8L	L12YC
MT45P	F17YC
MT55P	F15YC
MT65P	F14YC
MT75P	F14YC
T90	NAR14YC
TWE270	B12C
TWE275	B10C
KTM	BRISK
503.39.093.100	LR11SL
543.31.093.310	LR12SL
590.39.093.100	BR12YC-9
610.39.093.000	BR12YC-9
770.39.093.000	AR10S
772.39.093.000	CR10YS
780.39.093.000	MR12YS-9
KUBOTA	BRISK
12392-6771-1	L17YC
12581-6771-1	DR15YC-1
12647-6771-0	NR15YC
12647-6771-1	NR15YC
12681-6774-0	LR17C
12681-6774-1	LR17C
12863-6771-1	L17YC

KUBOTA	BRISK
12866-6771-1	L17YC
12992-6771-1	LR17YC
13078-6771-6	L15YC
13375-6774-0	L17YC
13901-6771-6	N15YC
13902-6771-1	N15YC
LANCIA	BRISK
55 190 788	BR14YC-9
55 190 7880	BR14YC-9
58 945 87	LR15YC
59 840 36	LR15YC
71 711 640	LR15YC
71 711 806	LR15YC
75 444 44	LR15YC
77 603 82	LR15YC
962 800 0280	DR15LDC
LD	BRISK
A6RTC	NAR15YS
A6RTC1	NAR15YS
A6TC	NAR15YS
A7RTC	NAR14YC
A7TC	NAR14YC
A8RTC	NAR12YS
A8TC	NAR12YS
B7RC	AR14YS
B8RC	AR12YS
C7E	AR14YS
CR7E	AR14YS
C8E	AR12YS
CR8E	AR12YS
C9E	AR10S
CR9E	AR10S
D7	B14C
D7CA	B14C
D7RC	BR14S
D7RTC	BR14YC-9
D7TC	BR14YC-9
D8C	B12C
D8RC	BR12S
D8RTC	BR12S
D8TC	B12C
DF7REC2	BR14YC-9
DK7RTC	BR14YC
E5T	N17YC
E5TC	N17YC
E5RTC	NR17YC
E6TC	N15YC
E7TC	N14YC
E8C	N14C
E8RC	NR14C
E8RTC	NR12YC
E8TC	N12YC
F7C	L14C
F8C	L14C
F5RTC	LR17YC
F5TC	LR17YC
F6RTC	LR15YC
F6TC	L15YC
F6TJC	LR15TC
F7RC	LR14C
F7TC	L14YC

LD	BRISK
F8RC	LR14C
G4C	K19
G6	K17C
G6C	K17C
K5RTC-11	DR17YC-1
K6EPPOR	DR15YP-1
K6RKCX	DR17LC-1
K6RKDC	DR17LDC
K6RLCX	A-line 36
K6RTC	DR17YC
K6TC	D17YC
K6TJC	DR17TC
K7RLC	A-line 28
K7RLCX	A-line 14
K7RTC	DR15YC
K7RTCX	A-line 11
K7RTDC	DR15LDC
K7RTJC	DR15TC
K7TC	D15YC
K7TJC	DR15TC
K7YKJCR	DR15TC
K8RTJC	DR14TC
KH6RKC3	ER15YC-1
L6	P17
L6T	P17Y
L7	P15
L7T	P15Y
L8RTF	PR17Y
N6	U17
N9	U15
P5TC	HR17YC
P5RTC	HR17YC
P6TC	HR15YC
P6RTC	HR15YC
P7TC	HR14YS
P7RTC	HR14YS
Q5RTC	GR17YC
Q5TC	G17YC
Q6RTC	GR17YC
Q6TC	G17YC
Q7TC	G15YC
T1137C	NAR14YC
T1137C	NAR14YS
T5RTC	FR17YC
T5TC	F17YC
T6RTC	FR15YC
T6TC	F15YC
LODGE	BRISK
15HLNY	L15YC
25HLD	DR15TC
25HLNY	L14YC
25XL	L15YC
2BTNY	FR17YC
2H	N15C
2HL	L15C
2HL10	NAR14YC
2HL10	NAR14YS
2HLD	D15YC
2HL-E	L15C
2HLN	L15C
2HLNY	L14YC



LODGE	BRISK
2HN	N15C
2HNY	N14YC
2H-TNY	FR14YC
2XL	L15YC
3HLN	L14C
3HLNY	L14YC
3HN	N14C
3HNY	LR12YC
4HLNY	LR12YC
5HLNY	LR12YC
BBNY	N17YC
BLN	L19
BLNY	L17YC
BLTY	GR17YC
BN	N19C
BTNY	FR17YC
C3	FR17C
CAN	K17C
CANB	P18Y
CANC	P17
CL14	L19
CLN	L17C
CLN14P	L19
CLNH	L19
CLNY	L17YC
CN	N19C
CNY	N17YC
CTN18	FR17C
CTNY	FR17YC
H	N17C
HBAN	K17C
HBL12	BR12S
HBLN	L19
HBN	N19C
HBTNY	FR15YC
HBTY	HR17YC
HL	L17C
HL12	BR10S
HL14	L17C
HL-E	L17C
HLN	L17C
HLNP	L17C
HLNY	L15YC
HN	N17C
HNY	N15YC
HT14	HR17YC
HT18	FR15YC
HTNY	FR15YC
H-TY	HR15YC
MAGNETI MARELLI	BRISK
061830072304	DR14YC
061830085304	LR14YC
061830086304	A-line 28
061830175304	L14YC
061830176304	N15YC
061830210304	L15YC
061830211304	LR15YC
061830215304	G15YC
061830254304	A-line 28
061830257304	NR15YC
061830258304	N17YC

MAGNETI MARELLI	BRISK
061830262304	GR15YC
061850022304	A-line 25
062000654304	N15YC
062000739304	L15YC
062000740304	LR15YC
062000754304	N15YC
CU7N	NAR14YC
CW10L	LR12SL
CW112L	L115L
CW11L	L115L
CW12L	L115L
CW13L	L105L
CW14L	L105L
CW225A	N15C
CW250A	N14C
CW260N	N14C
CW4A	L17C
CW5L	L17C
CW5LJ	L17C
CW5LS	L17C
CW5NR	NR17C
CW67L	L15C
CW67NJ	N15C
CW67NR	NR15C
CW6L	L17C
CW6LJ	L17C
CW6LS	L17C
CW6LSZ	L17C
CW6N	N15C
CW6NJ	N15C
CW6NR	NR15C
CW78L	L15C
CW7L	L15C
CW7LJ	L15C
CW7N	N15C
CW7NJ	N15C
CW7NR	NR15C
CW8L	L14C
CW8LJ	L14C
CW8N	N14C
CW8NR	NR14C
CW9L	L14C
CW9LJ	L14C
CW9N	N14C
CWC12NJ	N14C
CWC67NJ	N15C
CWC6NJ	N15C
CWC7NJ	N15C
CWC9NJ	N14C
CWF11L	LR12SL
CWP10L	L115L
CWP10N	N11S
CWP5N	NR15S
CWP6N	NR15S
CWP7N	NR15S
CWP8L	LR14S
CWP8N	NR14S
CWP9L	LR12SL
CWP9N	NR12S
CX8L	B12C

MAGNETI MARELLI	BRISK
FC7N	N15C
MARCHAL	BRISK
23F	FR15C
34 / 5HS	L15YC
35 / 1	N15YC
35 / 1B	N15YC
35 / 1D	N15YC
35HA	L15YC
36	N17C
36B	N17C
36D	N17C
36M	N17C
36P	N17C
37S	N17C
5N	N15YC
5NCYCLO	N15YC
64H	L14YC
6H	L14YC
6N	N14YC
70H	L15YC
76H	L17YC
7H	L15YC
84H	L17YC
88N	N17C
8H	L15YC
9H	L17YC
C64H	G15YC
C68H	G15YC
C7H	G15YC
F70H	D14YC
F74H	D15YC
F80H	D14YC
GT34	N14YC
GT34 / 2H	L15YC
GT34 / 5	N15YC
GT34 / 5D	N15YC
GT34 / 5H	L15YC
GT34 / 5HA	L15YC
GT34 / 5HD	L15YC
GT34D	N14YC
GT34H	L14YC
GT34HD	L15YC
GT35	N17YC
GT35D	N17YC
GT35H	L17YC
GT35HD	L17YC
RR31HS	L115L
RR32HS	L115L
RR33HSS	LR12SL
SCGT34 / 5H	G15YC
SCGT35H	G15YC
V36A	N17C
V6NSOLEX	N17C
MAZDA	BRISK
0000 18 1690	LR15YC
0000 18 8914	LR17YC
0000 18 B601	LR17YC-1
0000 18 BP01	A-line 36
0000 18 BP03	A-line 14
0000 18 BP47	A-line 32
0000 18 F201	DR15LC-1



MAZDA	BRISK
0000 18 F203	DR17LC-1
0000 18 F285	DR15LC-1
0000 18 F287	DR17LC-1
0000 18 JE41	DR17YP-1
0222 18 110	A-line 4
0259 18 110	L15YC
0370 18 110	LR15YP
0371 18 110	LR17YP
0660 18 110	L17YC
0745 18 110	L14YC
1002 77 550	A-line 8
1003 77 550	A-line 4
1534 18 110	A-line 8
1690 18 110	LR15YC
1A01 18 110	LR17YP
1A04 18 110	BR15YC
1A06 18 110	BR12YC
1A08 18 110	A-line 15
1A50 18 110	A-line 28
1A53 18 110	A-line 14
1N04 18 110	A-line 36
1N06 18 110	A-line 14
1N08 18 110	DR17YP-1
1N09 18 110	DR15YP-1
1N22 18 110	ER17YP-1
1UD3 18 110	P7
1UD4 18 110	P2
1UD6 18 110	P7
1UD7 18 110	P2
1UN7 18 110	P4
1UN9 18 110	P7
1UNA 18 110	P2
1UNC 18 110	P7
1UND 18 110	P2
1UNH 18 110	P1
1UT3 18 110	P7
1UT6 18 110	P7
1UT7 18 110	P2
1UX9 18 110	P7
1UXC 18 110	P7
1UXD 18 110	P2
1Y00 18 110	LR17YC
1Y01 18 110	LR15YC
1Y03 18 110	LR17YC-1
1Y06 18 110	A-line 32
1Y07 18 110	A-line 28
1Y09 18 110	A-line 36
1Y0A 18 110	A-line 14
1Y0B 18 110	A-line 34
1Y0F 18 110	BR14YC
1Y0G 18 110	DR17LC-1
1Y0H 18 110	DR15LC-1
1YR9 18 110	P7
3953 18 110	A-line 9
3954 18 110	A-line 2
8042 18 110	LR15YP-1
8914 18 110	LR17YC
A501 18 110	A-line 4
A502 18 110	L15YC
AY02 18 110	BR14YC
AY01 18 110	BR14YC

MAZDA	BRISK
AZ08 18 110	A-line 6
AZ09 18 110	A-line 6
B601 18 110	LR17YC-1
B602 18 110	A-line 38
B660 18 110	A-line 14
B667 18 110	A-line 14
B672 18 110	LR17YC
B695 18 110	A-line 12
B696 18 110	A-line 12
B683 18 110	A-line 36
B6B4 18 110	A-line 36
BP01 18 110	A-line 36
BP02 18 110	A-line 36
BP03 18 110	A-line 14
BP04 18 110	A-line 14
BP05 18 110	A-line 34
BP06 18 110	A-line 34
BP07 18 110	A-line 14
BP09 18 110	A-line 14
BP47 18 110	A-line 32
BP48 18 110	A-line 32
BP49 18 110	A-line 28
BP50 18 110	A-line 28
BP51 18 110	A-line 33
BPY1 18 110	A-line 36
BPY3 18 110	A-line 14
F201 18 110	DR15LC-1
F202 18 110A	DR15LC-1
F203 18 110	DR17LC-1
F204 18 110	DR17LC-1
F210 18 110	A-line 32
F211 18 110	A-line 32
F220 18 110	A-line 11
F221 18 110	A-line 11
F261 18 110	DR15LC-1
F285 18 110	DR15LC-1
F286 18 110	DR15LC-1
F287 18 110	DR17LC-1
F288 18 110	DR17LC-1
F289 18 110	DR17LC-1
F293 18 110	DR17LC-1
F2C5 18 110	DR15LC-1
F2C7 18 110	DR15LC-1
F8B1 18 110	DR15LC-1
F8B2 18 110A	DR15LC-1
F8B3 18 110	DR17LC-1
FE3N 18 110	A-line 34
FE6E 18 110	A-line 34
FE6F 18 110	A-line 34
FE79 18 110	LR15YC-1
FE82 18 110	A-line 13
FEEH 18 110	LR15YP-1
FEFB 18 110	LR15YC-1
JE03 18 110	A-line 33
JE26 18 110	P7
JE27 18 110	DR15YP-1
JE28 18 110	P7
JE41 18 110	DR17YP-1
JE42 18 110	DR17YP-1
JE43 18 110	DR15YP-1
JE44 18 110	DR15YP-1

MAZDA	BRISK
JE45 18 110	DR14YP-1
JE46 18 110	DR14YP-1
JF03 18 110	A-line 36
JF04 18 110	A-line 36
PBP01 18 110AA	A-line 36
TF50 18 110	DR15YP
Z601 18 110	P7
ZZS1 18 110	BR14YC
ZZS2 18 110	BR14YC
ZZS4 18 110	A-line 9
ZZS1 18 110	BR14YC
MBK	BRISK
94702003721	NAR15YS
9079Q0415500	N15C
9079Q0415600	N14C
9079Q0415700	N14C
9079Q0415800	L14C
9079Q0415900	L14C
9079Q0416000	LR12C
9079Q0416100	NR15YC
9079Q0416200	NR14YC
9079Q0416300	NR14C
9079Q0416400	LR12C
9079Q0491300	N12C
9079Q0507200	NR14C
9079Q0579000	LR14C
9079Q0579100	NR12C
9079Q0579200	AR14YS
9079Q0579300	AR12YS
MERCEDES-BENZ	BRISK
002 159 18 03	L14YC
002 159 22 03	L17YC
002 159 24 03	L15YC
002 159 27 03	L14YC
002 159 28 03	L15YC
002 159 29 03	L17YC
002 159 31 03	L17YC
002 159 41 03	L15YC
002 159 42 03	L15YC
002 159 48 03	L17YC
002 159 49 03	G15YC
002 159 56 03	G15YC
002 159 57 03	G17YC
002 159 58 03	G17YC
002 159 64 03	G14YC
002 159 65 03	G14YC
002 159 68 03	G15YC
002 159 69 03	G15YC
002 159 76 03	G17YC
002 159 77 03	D17YC
003 159 04 03	G17YC
003 159 05 03	G17YC
003 159 06 03	G15YC
003 159 07 03	G15YC
003 159 08 03	G14YC
003 159 10 03	L17YC
003 159 11 03	L17YC
003 159 12 03	L15YC
003 159 13 03	L15YC
003 159 14 03	L14YC
003 159 16 03	D15YC



MERCEDES-BENZ		BRISK		MERCEDES-BENZ		BRISK		MITSUBISHI		BRISK	
003 159 30 03	D17YC	A 003 159 34 03	G15YC	MS 851 182	L17YC						
003 159 31 03	D15YC	A 003 159 35 03	G15YC	MS 851 182A	L17YC						
003 159 33 03	G14YC	A 003 159 36 03	G17YC	MS 851 183	L15YC						
003 159 34 03	G15YC	A 003 159 37 03	D17YC	MS 851 184	L14YC						
003 159 35 03	G15YC	A 003 159 40 03	G17YC	MS 851 187	LR17YC-1						
003 159 36 03	G17YC	A 003 159 41 03	G17YC	MS 851 188	LR15YC-1						
003 159 37 03	D17YC	A 003 159 42 03	D17YC	MS 851 189	LR14TC-1						
003 159 40 03	G17YC	A 003 159 45 03	L15YC	MS 851 192	L15YC						
003 159 41 03	G17YC	A 003 159 46 03	L17YC	MS 851 207	LR17YC-1						
003 159 42 03	D17YC	A 003 159 47 03	L17YC	MS 851 208	LR15YC-1						
003 159 45 03	L15YC	A 003 159 56 03	L14YC	MS 851 212	L17YC						
003 159 46 03	L17YC	A 003 159 57 03	L15YC	MS 851 213	L15YC						
003 159 47 03	L17YC	A 003 159 67 03	D17YC	MS 851 215	L14YC						
003 159 56 03	L14YC	A 003 159 78 03	DR15YC	MS 851 217	LR17YC						
003 159 57 03	L15YC	A 003 159 90 03	DR17TC	MS 851 218	LR15YC						
003 159 67 03	D17YC	A 003 159 96 03	P7	MS 851 219	LR14YC						
003 159 78 03	DR15YC	A 003 159 96 03	P7	MS 851 227	LR17YC-1						
003 159 90 03	DR17TC	A 003 159 97 03	P2	MS 851 228	LR15YC-1						
003 159 96 03	P7	A 004 159 13 03	P3	MS 851 229	LR14TC-1						
003 159 96 03 26	P7	A 004 159 36 03	DR17YC-9	MS 851 232	LR17YC						
003 159 97 03	P2	A 004 159 50 03	DR17YP-1	MS 851 233	LR15YC						
003 159 97 03 26	P2	Q0003085V005000000	DR15LDC	MS 851 234	LR14YC						
004 159 13 03	P3	MERCURY	BRISK	MS 851 235	LR17YC						
004 159 19 03	P7	33-863622001	GR17LP-5	MS 851 236	LR15YC						
004 159 39 03	P11	MITSUBISHI	BRISK	MS 851 237	LR17YC-1						
3085V005000	DR15LDC	MD 313 442	DR17YP-1	MS 851 238	LR15YC-1						
315 99 203	DR15LDC	MD 313 443	DR15YP-1	MS 851 239	LR14TC-1						
A 002 159 18 03	L14YC	MD 314 766	DR14TC	MS 851 243	A-line 8						
A 002 159 22 03	L17YC	MD 319 517	DR15YP	MS 851 244	A-line 4						
A 002 159 24 03	L15YC	MD 320 543	DR14TC-1	MS 851 247	A-line 38						
A 002 159 27 03	L14YC	MD 320 572	A-line 32	MS 851 248	A-line 10						
A 002 159 28 03	L15YC	MD 321 150	DR15LDC-1	MS 851 283	A-line 4						
A 002 159 29 03	L17YC	MD 322 771	DR15YP-1	MS 851 286	A-line 8						
A 002 159 31 03	L17YC	MD 331 057	DR17LC-1	MS 851 287	A-line 4						
A 002 159 41 03	L15YC	MD 338 991	LR14YP	MS 851 292	LR15YP-1						
A 002 159 42 03	L15YC	MD 343 277	LR15YP	MS 851 301	LR17YP-1						
A 002 159 48 03	L17YC	MD 357 531	DR15YP	MS 851 302	LR15YP-1						
A 002 159 49 03	G15YC	MD 358 200	DR15LC-1	MS 851 316	BR15YC						
A 002 159 56 03	G15YC	MD 358 201	DR15LC-1	MS 851 317	BR14YC						
A 002 159 57 03	G17YC	MD 358 202	DR15LC-1	MS 851 332	DR15YP-1						
A 002 159 58 03	G17YC	MD 361 067	P7	MS 851 335	DR17YP-1						
A 002 159 64 03	G14YC	MD 362 097	DR17LC-1	MS 851 336	DR15YP-1						
A 002 159 65 03	G14YC	MD 362 098	DR17LC-1	MS 851 346	DR15YP						
A 002 159 68 03	G15YC	MD 372 421	DR17LDC-1	MS 851 351	A-line 16						
A 002 159 69 03	G15YC	MD 372 553	P7	MS 851 352	A-line 17						
A 002 159 76 03	G17YC	MD 372 588	P2	MS 851 353	A-line 17						
A 002 159 77 03	D17YC	MD 373 645	P2	MS 851 354	A-line 16						
A 003 159 04 03	G17YC	MD 378 582	P4	MS 851 357	A-line 36						
A 003 159 05 03	G17YC	MS 851 022	L17YC	MS 851 358	A-line 14						
A 003 159 06 03	G15YC	MS 851 023	L15YC	MS 851 359	A-line 34						
A 003 159 07 03	G15YC	MS 851 024	L14YC	MS 851 361	A-line 36						
A 003 159 08 03	G14YC	MS 851 027	LR17YC-1	MS 851 362	A-line 11						
A 003 159 10 03	L17YC	MS 851 028	LR15YC-1	MS 851 363	A-line 34						
A 003 159 11 03	L17YC	MS 851 029	LR14TC-1	MS 851 364	A-line 36						
A 003 159 12 03	L15YC	MS 851 097	A-line 8	MS 851 365	A-line 14						
A 003 159 13 03	L15YC	MS 851 102	A-line 8	MS 851 366	A-line 34						
A 003 159 14 03	L14YC	MS 851 104	A-line 4	MS 851 367	A-line 32						
A 003 159 16 03	D15YC	MS 851 107	A-line 38	MS 851 368	A-line 28						
A 003 159 30 03	D17YC	MS 851 108	A-line 10	MS 851 382	A-line 28						
A 003 159 31 03	D15YC	MS 851 126	A-line 2	MS 851 387	A-line 36						
A 003 159 33 03	G14YC	MS 851 132	N17C	MS 851 388	A-line 14						



MITSUBISHI	BRISK
MS 851 396	BR15YC
MS 851 397	BR14YC
MS 851 402	A-line 6
MS 851 403	LR15YC
MS 851 408	LR15YC
MS 851 412	LR17YC
MS 851 413	LR15YC
MS 851 414	LR14YC
MS 851 417	LR17YC-1
MS 851 418	LR15YC-1
MS 851 419	LR14TC-1
MS 851 437	A-line 8
MS 851 438	L15YC
MS 851 439	L14YC
MS 851 463	LR15YP-1
MS 851 473	DR15YP-1
MS 851 478	LR15YC-1
MS 851 486	BR15YC
MS 851 487	BR14YC
MS 851 501	DR17YP-1
MS 851 502	DR15YP-1
MS 851 506	DR15YP
MS 851 721	A-line 16
MS 851 722	A-line 17
MS 851 727	A-line 36
MS 851 728	A-line 14
MS 851 729	A-line 34
MS 851 732	A-line 14
MS 851 737	A-line 32
MS 851 738	A-line 28
MS 851 783	DR14TC-1
MS 851 861	DR15YP
MS 851 872	A-line 34
MZ 602 020	P7
MZ 602 021	P2
MZ 602 026	P7
MZ 602 027	P2
MZ 602 040	P7
MZ 602 043	P7
MZ 602 044	P2
MZ 602 063	P7
MZ 602 064	P2
MZ 602 065	P7
MZ 602 066	P2
MZ 602 069	P1
MZ 602 076	P2
MZ 602 078	P2
MZ 602 079	P2
MZ 602 082	P7
SM D31 3443	DR15YP-1
SS MS8 513 64	A-line 36
Z2 152 944	LR15YC-1
Z2 152 945	LR15YC
Z2 152 947	LR14YC
Z2 152 948	LR14TC-1
Z2 152 949	DR14YC-1
Z2 152 950	DR15YC-1
MOTORCRAFT	BRISK
1Y00	LR17YC
1Y01	LR15YC
1Y03	LR17YC-1

MOTORCRAFT	BRISK
1Y06	A-line 32
1Y07	A-line 28
1Y09	A-line 36
1Y0A	A-line 14
1Y0B	A-line 34
1Y0F	BR14YC
1Y0G	DR17LC-1
1Y0H	DR15LC-1
1YR9	P7
AE22	N15YC
AE22C	N15YC
AE32	N15YC
AE32C	N15YC
AE4	N17C
AE42	N17YC
AE4X	N17C
AE52	N17YC
AE6	N17C
AE62	N17YC
AER32	NR15YC
AF12	HR14YS
AF22	HR15YC
AF32	HR15YC
AF42	HR17YC
AG12	L14YC
AG12C	L14YC
AG12CU	L14YC
AG22	L15YC
AG224	LR15YC-1
AG22C	L15YC
AG22CU	L15YC
AG252	L15YC
AG252C	L15YC
AG32A	L15YC
AG32C	L15YC
AG32CU	L15YC
AG34CU	A-line 4
AG34CU11	A-line 10
AG42	L17YC
AG42CU	L17YC
AG44CU	A-line 8
AG501X	L10SL
AG52	L17YC
AG701X	L11SL
AG901X	LR12SL
AG902	L12YC
AGF12	G14YC
AGF12C	G14YC
AGF22C	G15YC
AGF32CU	G15YC
AGFS22C1	GR15YC
AGFS22FE1	GR15YP-1
AGFS22IPJ	P6
AGFS22YPC	P6
AGFS32C1	GR15YC
AGN42	L17YC
AGP12C	D14YC
AGP22C	D15YC
AGPR12C	DR14YC
AGPR12P	DR14YP-1
AGPR12PP	DR14YP-1

MOTORCRAFT	BRISK
AGPR12PP11	DR14YP-1
AGPR12PP8	DR14YP
AGPR22C	DR15YC
AGPR22C1	DR15YC-1
AGPR22CD	DR15YC
AGPR22CD1	DR15YC-1
AGPR22P	DR15YP-1
AGPR22PP	DR15YP-1
AGPR22PPJ	DR15YP-1
AGPR32C	DR15YC
AGPR32CD1	DR15YC-1
AGPS12C	DR14YC
AGPS12P1	DR14YP-1
AGPS22C	DR15YC
AGPS22C1	DR15YC-1
AGPS22P	DR15YP-1
AGPS22P1	DR15YP-1
AGPS22PP1	DR15YP-1
AGPS32C	DR15YC
AGPS32C1	DR15YC-1
AGPS44F	DOX15LE-1
AGPS44F11	DOX15LE-1
AGPS44F11J	DOX15LE-1
AGR12C	LR14YC
AGR21	LR15C
AGR22	LR15YC
AGR22C	LR15YC
AGR22CU	LR15YC
AGR31	LR15C
AGR32	LR15YC
AGR32C	LR15YC
AGR32CU	LR15YC
AGR34CU	A-line 2
AGR3X	LR15C
AGR41	LR17C
AGR42	LR17YC
AGR42CU	LR17YC
AGR44CU	A-line 9
AGR44CU11	A-line 38
AGR51	LR17C
AGR52	LR17YC
AGR54CU	A-line 9
AGRF22	GR15YC
AGRF22C	GR15YC
AGRF22C1	GR15YC-1
AGRF22PP1	GR15YP-1
AGRF32	GR15YC
AGRF32C1	GR15YC-1
AGRF42	GR17YC
AGRF52	GR17YC
AGS22C	LR15YC
AGS32C	LR17YC
AGS32C11	LR17YC-1
AGSF22FM1	A-line 31
AGSF22FSCM	GR15YP-1
AGSF22PGM	GR15YP-1
AGSF22PM	GR15YP-1
AGSF22PP	GR15YP-1
AGSF22PPJ	GR15YP-1
AGSF22PPM	GR15YP-1



MOTORCRAFT	BRISK
AGSF22WWM	GR15YC
AGSF22YPC	GR15YP-1
AGSF32C	GR17YC
AGSF32FEC	A-line 31
AGSF32FEM	A-line 31
AGSF32FM	A-line 31
AGSF32WWM	A-line 31
AGSF32YPC	A-line 31
AGSP32	DR15YC-1
AGSP32C	DR15YC-1
AGSP32FP	DR17YP-1
AGSP32PR	DR15YP-1
AGSP33C	DR15LC-1
AGSP52	DR17YC
ARF22	HR15YS
ARF22C	HR15YS
ARF22CU	HR15YS
ARF32	HR15YS
ARF326	HR15YS
ARF32C6	HR15YS
ARF32M	HR15YS
ARF42	HR17YC
ARF42CU	HR17YC
ASF32	HR15YS
ASF32C	HR15YS
ASF32M	HR15YS
AV22CU	N15YC
AV4	N17C
AV42	N17YC
AV52	N17YC
AWRF32	GR15YC
AWRF42	GR17YC
AWSF22C	GR15YC
AWSF22F	GR15YP-1
AWSF22F5	GR15YP-1
AWSF32	GR15YC
AWSF32C	GR15YC
AWSF32F	A-line 31
AWSF32P	A-line 31
AWSF32PM	A-line 31
AWSF32PP	A-line 31
AWSF42	GR17YC
AWSF42C	GR17YC
AWSF52C	GR17YC
AWSFA32C	GR17YC
AYFS22PP1	A-line 25
AYFS22C	RR15YC-1
AYFS22CB	RR15YC-1
AYFS22FE1J	A-line 25
AYFS22FPM1	A-line 25
AYFS22PP	A-line 25
AYFS22PP1	A-line 25
AYRF22P	A-line 25
AYRF22PP	A-line 25
AYSF32YPC	P5
AZFS22C	RR15YC-1
AZFS22PP	A-line 25
AZFS32FE	A-line 25
BF22	F15YC
BF22C	F15YC
BF22CU	F15YC

MOTORCRAFT	BRISK
BF22CX	F15YC
BF22X	F15YC
BF3	FR15C
BF32	F15YC
BF32CU	F15YC
BF32CX	F15YC
BF32X	F15YC
BF42	F17YC
BF42CU	F17YC
BF82	F17YC
BF92	F17YC
BFS22C	FR15YC
BFS32C	FR15YC
BFS32C1	FR15YC
BRF22	FR15YC
BRF22C	FR15YC
BRF31	FR15C
BRF314	FR15C
BRF32	FR15YC
BRF3M	FR15C
BRF42	FR17YC
BRF82	FR17YC
BSF31	FR15C
BSF314	FR15C
BSF82	FR17YC
BTF3	FR15C
BTF31	FR15C
BTF42	F17YC
BTF6	FR15C
BTRF42	FR17YC
MV AGUSTA	BRISK
80099561	AR10S
NGK	BRISK
0127	P2
1005	P3
1015	L14C
1034	L14YC
1041	DR15LC-1
1046	N15YC
1068	BR15YC
1080	A-line 11
1084	DR15YP-1
1087	A-line 19
1089	A-line 34
1094	GR14S
1095	DR14YC-1
1098	NR14C-1
1111	L14C
1128	LR15TC
1134	NR14C-1
1144	A-line 19
1145	A-line 32
1146	A-line 12
1147	J19
1148	A-line 36
1183	A-line 7
1208	P3
1212	L15YC-1
1219	P7
1223	SR15C

NGK	BRISK
1228	J17
1233	A-line 9
1235	HR15YC
1243	DR17YP-1
1263	LR15TC
1266	A-line 32
1267	A-line 34
1268	U15Y
1269	A-line 12
1270	UR17Y
1271	A-line 34
1272	A-line 33
1273	A-line 36
1275	AR12YS
1277	H15YS
1283	A-line 34
1294	KR17C
1299	B08S
1314	P2
1496	A-line 20
1563	BR12YC-9
1578	QR15LC-1
1632	DR15YP-1
1633	CR10YS
1662	A-line 36
1664	DOX15LE-1
1667	A-line 32
1675	DR14YP
1731	J19
1732	P17
1733	K17C
1734	J17
1959	A-line 40
2000	D10IR
2001	D08IR
2023	LR14YC
2051	NAR15YS
2055	L10SL
2055	L10S
2056	A-line 33
2059	A-line 34
2060	NAR14YC
2060	NAR14YS
2075	DR17TC
2078	DR14TC
2086	NAR12YS
2087	A-line 32
2090	DR14TC-1
2093	DR15YP
2095	DR14TC
2097	DR17YP-1
2098	N10S
2108	LR12C
2120	B12C
2127	F14YC
2129	N14C-1
2140	L17YC
2141	DR14YC-1
2142	AR10S-9
2144	UR17
2145	L11S



NGK	BRISK	NGK	BRISK	NGK	BRISK
2145	L11SL	2489	A-line 2	2978	DR15YP-1
2157	D10IR	2526	A-line 36	2983	NAR15YS
2158	L11SL	2527	HR19YC-1	3000	DR17YP-1
2164	DR14TC	2528	LR14S	3011	K17Y
2168	NAR12YS	2546	DR17YP	3014	N14C
2170	BR10S	2556	BR12S	3028	A-line 38
2171	L10SL	2574	P2	3045	DR15TC-1
2171	L10S	2610	F17YC	3045	A-line 24
2184	L10SL	2611	LR12C	3064	P1
2193	AR14YS	2614	NAR15YS	3066	TR14C
2197	DR15TC	2621	NR12S	3066	TR14S
2199	L10SL	2623	HR15YC	3100	DR15YP
2204	BR12S	2630	N12YC	3107	P7
2210	FR15C	2641	BR10YS-9	3108	BR15YC
2213	DR15LDC-1	2645	DR15YP	3122	FR17YC
2215	DR15YP	2647	DR17YP-1	3123	BR14S
2223	GR17YC	2659	L10SL	3130	LR12SL
2230	H19YC	2660	DR12S	3132	A-line 11
2236	NAR12YS	2664	P2	3153	A-line 9
2238	GR17YC-1	2667	P9	3169	DR12YP
2249	A-line 28	2680	P17	3172	LR15TC
2256	BR15YC	2684	DR15YP-1	3186	A-line 31
2261	LR17YC-9	2687	P4	3188	BR10S
2262	DR17LC-1	2689	LR115L	3194	LR12C
2265	BR12YP	2690	P9	3197	DR15TC
2268	A-line 2	2710	F15YC	3200	LR14YP
2270	A-line 33	2712	LR14YC-1	3201	P15Y
2271	DR17YP-1	2720	B08S	3210	K19
2285	LR17LC	2721	N11S	3215	P7
2284	DR15LDC-1	2737	DR15LC-1	3230	LR11SL
2287	LR17TC	2738	LR17YP-1	3236	LR12SL
2288	DR15LDC	2743	DR15YP-1	3240	DR15YP-1
2300	DR17YP-1	2756	A-line 14	3245	L11SL
2305	AR10S	2776	DR14YP	3252	LR11S
2319	K17C	2781	DR12YP	3306	P7
2330	DR15YC	2789	DR17TC	3313	P2
2353	DR15YP-1	2792	N14C	3323	FR15C
2355	A-line 36	2798	ER15YC-1	3330	DR14YC
2360	AR08S	2821	LR12SL	3346	GR14S
2363	BR14YC	2828	A-line 9	3350	DR15YP-1
2364	A-line 8	2834	BR10YS-9	3355	L14YC
2365	DR17YP-1	2842	BR14S	3365	TR15C
2372	DR17YP-1	2848	DR15LDC	3377	LR17TC
2380	DR14YP-1	2850	BR12YP	3400	LR14YP-1
2382	DR17YC-1	2851	A-line 38	3403	GR17YP-5
2387	DR14YC-1	2867	DR17YP-1	3410	J17
2391	A-line 36	2871	BR10S	3430	LR12SL
2392	DR17YP	2874	NAR17	3437	BR10S
2397	DR15TC-1	2876	A-line 1	3440	DR17YP-1
2399	N11S	2877	L14C	3447	LR17TC-1
2400	LR14YP-1	2889	DR17LDC	3478	AR12YS
2411	L14C	2912	L12YC	3481	BR15YC
2412	L14YC	2919	DR08GS	3483	BR12YC-9
2417	N15C	2922	FR15YC	3486	AR14YS
2420	B10C	2923	BR12S	3500	DR15YP
2421	NR14S	2941	A-line 15	3510	K17C
2445	DR17YP-1	2946	AR08GS	3522	KR17C
2446	DR15YP-1	2948	A-line 10	3524	DR17YC-1
2460	DR17YC	2950	DR17YP	3526	G14YC
2467	A-line 25	2963	P18Y	3530	L11S
2470	A-line 22	2975	A-line 34	3530	L11SL



NGK	BRISK
3539	DR15YP
3540	DR15YP-1
3544	DR14YP
3546	DR15YP-1
3573	LR17YP-1
3577	A-line 10
3583	DR15LDC-1
3586	P1
3609	P6
3623	GR15YC
3630	L10SL
3630	L10S
3652	P2
3664	A-line 9
3672	ER15YC-1
3678	P2
3683	L14C
3684	LR14TC
3688	DR15YP-1
3696	A-line 28
3712	G17YC
3717	BR10YS-9
3720	A-line 11
3722	NR17C
3725	NR12YC
3735	A-line 12
3738	LR15YP-1
3753	DR15YP-1
3764	P2
3783	DR15YC
3784	A-line 31
3785	LR14YC
3812	G15YC
3830	LR10SL
3841	JR19
3850	PR17
3869	DR15LC-1
3922	NR15C
3923	LR12YC
3932	BR14YC
3933	DR15YP
3951	GR17YP-5
3961	LR14C
3964	DR17LDC
3967	DR17LDC-1
3971	LR17YP-1
3975	A-line 18
3978	DR14YP-1
3987	LR17YP
3988	LR12C
3992	LR12SL
3993	LR10SL
3994	L12YC
3995	L14YC
3997	LR12SL
3998	L11S
3998	L11SL
4002	PR17
4004	PR17
4006	LR17YC
4007	L15YC

NGK	BRISK
4008	LR15YC
4014	DR15YP-1
4015	LR11SL
4017	DR08GS
4045	DR15YP-1
4073	A-line 14
4095	P1
4110	N19C
4111	N17YC
4114	PR18Y
4120	A-line 36
4122	NR14C
4133	JR17
4172	LR12SL
4174	P2
4177	GR15YC-1
4179	BR12YC
4180	DR14YP
4200	NR15C
4210	N17C
4226	PR15
4228	A-line 10
4233	LR15YP-1
4234	LR10S
4259	AR14YS
4291	DR15LC-1
4292	DR17YP-1
4293	A-line 28
4294	P1
4297	BR10S
4322	NR14C
4339	BR12YC
4341	DR17YP-1
4342	A-line 40
4345	PR15Y
4364	DR14YP
4368	A-line 14
4371	DR14YP
4377	DR15YP
4388	A-line 20
4415	BR14YC
4424	LR17YC-1
4429	NAR17
4450	AR12YS
4458	P3
4477	P6
4483	A-line 23
4485	DR14YP-1
4497	DR15YP-1
4509	AR14YS
4510	N15C
4511	N15YC
4522	NR12C
4542	LR15YP
4546	AR12YS
4548	AR10S
4549	NAR14YC
4549	NAR14YS
4553	A-line 3
4563	DR15TC
4578	AR14YS

NGK	BRISK
4579	DR14YP-1
4588	DR17YP-1
4589	P2
4618	JR19
4619	A-line 28
4626	PR15Y
4626	PR17YC
4629	NAR14YC
4629	NAR14YS
4632	NR15YC
4639	DR15YP-1
4642	DR17YP-1
4651	DR15YP-1
4663	AR14YS
4677	LR11SL
4684	LR12SL
4685	DR14YP-1
4691	L17YC
4696	P7
4722	LR17C
4737	NR14C
4762	HR19YC-1
4775	ER17YP-1
4783	A-line 16
4793	DR15YP
4795	BR14YC
4832	LR12SL
4853	DR14YP
4854	AR12YS
4855	BR12S
4856	A-line 28
4867	P4
4875	LR17YP
4904	P3
4907	P2
4912	P11
4915	NR14C
4919	P2
4922	LR15C
4929	BR12YC-9
4930	D15YC
4952	DR14YC-1
4959	DR15LDC
4968	P6
4975	A-line 16
4984	LR15YP
4996	P7
5006	AR10S
5030	D14YC
5055	A-line 25
5068	DOR12YS-1
5077	A-line 15
5084	DR17LC-1
5096	AR14YS
5110	N14C
5111	N14YC
5122	LR14C
5126	N14C-1
5129	BR14YC-9
5135	DR17TC
5141	GR15YP-1



NGK	BRISK	NGK	BRISK	NGK	BRISK
5156	LR17TC-1	5776	A-line 36	6418	P4
5165	DR17LC	5794	P9	6421	U15
5170	LR12YC	5798	JR19	6422	NR14YC
5182	DR17YP-1	5809	P6	6427	A-line 2
5216	DR17LDC	5810	N12C	6430	DOX15LE-1
5238	DR10S	5811	A-line 8	6436	BR10YS-9
5266	P1	5823	LR17YC	6437	DR15TC
5275	DR15YP	5827	L11S	6441	P1
5282	A-line 11	5827	L115L	6452	NAR17
5329	BR10YS-9	5829	BR12YC-9	6458	DR15YP
5339	A-line 13	5831	L10SL	6464	A-line 2
5341	DR17YP	5831	L10S	6465	A-line 14
5343	NR15YC	5832	LR15YP	6466	A-line 5
5344	P2	5838	DR17YP-1	6487	AR12YS
5368	P2	5839	A-line 15	6507	P4
5372	LR14YP	5848	P6	6509	P5
5375	A-line 28	5851	AR12YS	6521	P15
5393	A-line 32	5860	A-line 17	6535	NAR17
5422	LR14C	5866	LR17C	6548	AR08S
5423	BR12S	5874	DR15YP-1	6569	DR17YP-1
5454	AR10S-9	5913	A-line 33	6615	LR14C
5459	DR17YP-1	5921	P17	6619	P3
5461	DR15TC	5927	L10SL	6629	BR10YS-9
5461	A-line 27	5927	L10S	6630	HR19YC-1
5463	DR17YP-1	5932	LR17TC-1	6643	MR15LP-1
5464	P7	5932	A-line 21	6696	DR17YC-1
5469	BR14S	5940	LR10SL	6703	PR15Y
5496	DR14TC	5942	MR14LC	6703	PR17YC
5509	DR14TC	5950	U17Y	6711	DOX15LE-1
5510	N14C	5960	DOX15LE-1	6714	A-line 32
5531	BR15YC	6021	P17	6714	A-line 32
5534	LR14YC	6043	P11	6715	NR14C
5541	NR14YC	6046	P10	6717	A-line 28
5542	DR15YP-1	6097	A-line 33	6719	A-line 32
5553	DR15YC-1	6129	A-line 12	6720	U17
5555	DR15YP-1	6130	DR17YC	6726	PR18Y
5584	DR17LC-1	6208	NAR12YS	6735	LR17YC-1
5585	DR15LC-1	6213	CR10YS	6737	DOX15LE-1
5600	AR10S	6221	U17	6741	P2
5623	A-line 9	6222	NR17YC	6743	PR17
5627	LR125L	6237	A-line 17	6745	A-line 36
5629	BR14YC-9	6240	ER17YP-1	6746	P15
5632	A-line 11	6248	LR15YP	6749	PR17
5637	A-line 4	6261	A-line 10	6753	U17Y
5637	A-line 4	6263	AR10S	6757	LR15TC
5638	A-line 38	6264	AR08S	6759	PR18Y
5643	DR17YC-1	6282	DR14YC	6761	PR15Y
5648	P4	6290	DR15YP-1	6761	PR17YC
5649	DR15LDC	6313	DR14YC-1	6764	LR15YP
5666	AR12YS	6314	DR15YP	6773	LR17YC
5667	DR14YP-1	6338	A-line 33	6775	LR15YC
5689	P4	6342	DR17TC	6776	TR17
5690	P9	6342	A-line 29	6776	TR17C
5692	BR12YC-9	6344	A-line 31	6778	TR15C
5722	LR12C	6345	A-line 32	6779	DR15YC-1
5724	A-line 14	6345	A-line 32	6784	SR14C
5728	PR17	6354	BR12YP	6785	TR14C
5757	DR15YP-1	6364	DR15YC	6785	TR14S
5758	P1	6371	DR17YP-1	6786	NAR17
5760	LR17YP-1	6378	AR12YS	6787	JR19
5773	DR15YP	6410	L17C	6799	MR14LC



NGK	BRISK	NGK	BRISK	NGK	BRISK
6821	NAR12YS	7543	SR14C	APR6FS	FR15YC
6832	LR14TC-1	7546	AR14YS	AR6FS	FR15C
6838	DR15YP-1	7548	LR12SL	B2-LM	J19
6855	A-line 34	7553	DR17TC-1	B-4	K19
6884	CR10YS	7558	DR17LC	B4H	N19C
6893	DOX15LE-1	7569	P6	B4-LM	J17
6895	A-line 26	7586	A-line 25	B5ES	L17C
6937	A-line 38	7599	TR17	B5HS	N17C
6953	A-line 36	7599	TR17C	B6ES	L15C
6955	AR10S	7613	LR12SL	B6HS	N15C
6962	A-line 28	7632	LR17YC	B6S	K17C
6987	DR15LC-1	7634	LR17YC-1	B7ECS	LR14S
6891	P6	7639	L15YC	B7EGV	LR14YS
6992	DR15TC	7642	A-line 32	B7HCS	NR14S
6994	P1	7654	A-line 40	B7ES	L14C
7004	AR14YS	7658	P2	B7HS	N14C
7021	P18Y	7727	A-line 4	B7HS-10	N14C-1
7022	NR15YC	7734	LR17YC	B8ECS	LR12SL
7026	LR15YP	7737	LR14TC-1	B8EG	LR12SL
7037	LR15YC-1	7743	DOX15LE-1	B8EGV	LR12SL
7086	DR17YP-1	7784	AR12YS	B8ES	L14C
7088	DR15YP-1	7787	ER15YC-1	B8HCS	NR12S
7090	DR17YP-1	7797	DR17LDC	B8HS	N14C
7092	DR15YP-1	7803	P10	B8HS-10	N14C-1
7113	ER17YC-9	7822	LR15YC	B8SEGV	LR12SL
7131	LR15YC	7824	LR15YS	B9ECS	L11SL
7133	LR15YC-1	7832	L17YC	B9EG	L11S
7148	LR12C	7834	A-line 8	B9EG	L11SL
7162	BR12S	7839	BR14S	B9EGV	L11S
7210	DR15YC-1	7840	NAR17	B9EGV	L11SL
7226	LR14TC-1	7854	P7	B9ES	LR12C
7264	LR17TC-1	7862	GR17LP-5	B9HCS	N11S
7265	A-line 19	7866	P7	B9HS	N12C
7265	A-line 19	7873	DR14TC	B9SEGV	L11S
7281	A-line 6	7901	P10	B9SEGV	L11SL
7321	P15Y	7912	B14C	B10HS	N11S
7327	A-line 8	7928	LR12SL	B10ECS	L10SL
7331	N15YC	7938	A-line 32	B10EG	L10SL
7333	L15YC	7956	DR17LDC	B10EG	L10S
7340	A-line 14	7963	DR14YP	B10EGV	L10SL
7354	DR14TC	7968	DOX15LE-1	B10EGV	L10S
7373	DR17YC-1	7990	A-line 28	B10ES	LR12SL
7390	A-line 32	7994	P7	B10SEGV	L10SL
7411	AR12YS	7997	DR14TC-1	B10SEGV	L10S
7418	P7	7998	DX15LTC-1	B11EG	L10S
7421	PR17	8940	DR17YP	B11EG	L10SL
7423	NAR12YS	9329	P1	B11EGV	L10SL
7432	L15C	10029	A-line 9	B11EGV	L10S
7444	B08S	10032	A-line 12	BCP5E	A-line 16
7471	AR12YS	10048	A-line 28	BCP5ES	D17YC
7472	P15Y	90117	P5	BCP5ET	DR17TC
7473	AR12YS	93482	P11	BCP6E	A-line 17
7496	D17YC	94460	DR12YP	BCP6E-11	A-line 11
7498	LR12SL	94940	P11	BCP6ES	D15YC
7499	AR10S	99404	P4	BCP6ES-11	DR15YC-1
7502	AR10S-9	97225	CR10YS	BCP6ET	DR15TC
7505	P3	A6FS	FR15C	BCP7E	A-line 33
7517	LR15TC	AP5FS	F17YC	BCP7E-11	A-line 34
7526	LR12YC	AP6FS	F15YC	BCP7ES	D14YC
7532	LR17YC-1	AP7FS	F14YC	BCP7ES-11	DR14YC-1
7534	N15C	APR5FS	FR17YC	BCP7ET	DR14TC



NGK	BRISK
BCPR5E	A-line 32
BCPR5E-11	A-line 36
BCPR5EGP	DR17YP-1
BCPR5EIX-11	P7
BCPR5EIX-11P	P7
BCPR5EP-8	DR17YP
BCPR5EP-11	DR17YP-1
BCPR5E5	DR17YC
BCPR5E5-11	DR17YC-1
BCPR5ET	DR17TC
BCPR5EVX-11	DR17YP-1
BCPR5EY	A-line 32
BCPR5EY-N-11	A-line 36
BCPR6E	A-line 12
BCPR6EGP	DR15YP-1
BCPR6E-11	A-line 11
BCPR6EIX	P4
BCPR6EIX-11	P2
BCPR6EIX-11P	P2
BCPR6EP-8	DR15YP
BCPR6EP-11	DR15YP-1
BCPR6EP-N-8	DR15YP
BCPR6EP-N-11	DR15YP-1
BCPR6E5	DR15YC
BCPR6E5-11	DR15YC-1
BCPR6ET	DR15TC
BCPR6EVX-11	DR15YP-1
BCPR6EY	A-line 12
BCPR7E	A-line 33
BCPR7E-11	A-line 34
BCPR7EIX	P9
BCPR7E5	DR14YC
BCPR7E5-11	DR14YC-1
BCPR7ET	DR14TC
BCPR7EY	A-line 33
BCPR7EY-11	A-line 34
BCPR7EY-N-11	A-line 34
BCPR7EVX-11	DR14YP-1
BCPR8E5	DR12YC
BCPR9E5	DOR10IR
BK5E	A-line 16
BK5E5	D17YC
BK6E-11	A-line 14
BK7EK-N-11	DR14TC-1
BKR5E	A-line 32
BKR5E-11	A-line 36
BKR5EGP	DR17YP-1
BKR5EIX-11	P7
BKR5EIX-11P	P7
BKR5EK	DR17LDC
BKR5EKB-11	DR17LDC-1
BKR5EKC	DR17LDC
BKR5EKC	DR17LDC
BKR5EKC	DR17LDC
BKR5E-N	A-line 32
BKR5E-N-11	A-line 36
BKR5EP-8	DR17YP
BKR5EP-11	DR17YP-1
BKR5E5	DR17YC
BKR5E5-11	DR17YC-1
BKR5ESA-11	DR17YC-1
BKR5EX	DR17YP

NGK	BRISK
BKR5EY	A-line 32
BKR5EY-11	A-line 36
BKR5EYA	A-line 32
BKR5EYA-11	A-line 36
BKR5EZ	A-line 32
BKR5N-11	A-line 36
BKR5EVX	DR17YP
BKR5EVX-11	DR17YP-1
BKR5EZ	A-line 32
BKR6E	A-line 28
BKR6E-11	A-line 14
BKR6E-11D	A-line 14
BKR6E-D	A-line 28
BKR6EB	A-line 28
BKR6EGP	DR15YP-1
BKR6EIX	P4
BKR6EIX-11	P2
BKR6EIX-11P	P2
BKR6EK	DR15LDC
BKR6EKB-11	DR15LDC-1
BKR6EKC	DR15LDC
BKR6EKC-11	DR15LDC-1
BKR6EKC-D	DR15LDC
BKR6EKC-N-11	DR15LDC-1
BKR6EKE	DR15LDC
BKR6E-N	A-line 28
BKR6E-N-11	A-line 14
BKR6EP-8	DR15YP
BKR6EP-11	DR15YP-1
BKR6EP-N-8	DR15YP
BKR6E5	DR15YC
BKR6E5-11	DR15YC-1
BKR6ESZ-10	DR15YC-1
BKR6ETA-10	DX15LTC-1
BKR6EY	A-line 28
BKR6EY-11	A-line 14
BKR6EYA	A-line 28
BKR6EYA-11	A-line 14
BKR6EVX	DR15YP
BKR6EVX-11	DR15YP-1
BKR6EVXA-11	DR15YP-1
BKR6EZ	A-line 28
BKR6EZB	A-line 28
BKR6N-11	A-line 14
BKR7E	A-line 33
BKR7E-11	A-line 34
BKR7EIX	P9
BKR7EIXP	P9
BKR7E-N	A-line 33
BKR7EKC	DR14TC
BKR7EKC-D	DR14TC
BKR7EKC-N	DR14TC
BKR7E5	DR14YC
BKR7E5-11	DR14YC-1
BKR7ESB	A-line 33
BKR7ESB-D	A-line 33
BKR7ESC-11	DR14YC-1
BKR7EY	A-line 33
BKR7EY-11	A-line 34
BKR7EVX	DR14YP
BKR7EVX-11	DR14YP-1

NGK	BRISK
BKR8E5	DR12YC
BKUR5ET	DR17TC
BKUR5ET-10	DR17TC-1
BKUR6EK	DR15LDC-1
BKUR6ET	DR15TC
BKUR6ET-10	DR15TC-1
BKUR6ETB	DR15TC
BKUR7ET	DR14TC
BKUR7ETB-10	DR14TC-1
BM6A	P17
BM6F	U17
BM7A	P15
BM7F	U15
BMR4A	PR17
BMR6A	PR17
BMR6F	UR17
BMR7A	PR15
BP4F5	H19YC
BP5E	A-line 8
BP5EA	A-line 8
BP5EA-L	A-line 8
BP5EF5	G17YC
BP5E5	L17YC
BP5ESA	LR17LC
BP5ESZ	L17YC
BP5ET	DR17TC
BP5ET-10	LR17TC-1
BP5EY	A-line 8
BP5HS	N17YC
BP5S	K17Y
BP6E	A-line 4
BP6EF	A-line 5
BP6EF5	G15YC
BP6E5	L15YC
BP6E5-11	L15YC-1
BP6ESZ	L15YC
BP6ET	DR15TC
BP6EV	LR15YS
BP6EVX	LR15YP
BP6EY	A-line 4
BP6H	A-line 18
BP6HS	N15YC
BP6HSA	N15YC
BP7EF5	G14YC
BP7E5	L14YC
BP7E5-11	LR14YC-1
BP7ET	LR14TC
BP7EY	A-line 14
BP7HS	N14YC
BP8E5	L12YC
BP8HS	N12YC
BP9E5	LR12YC
BPM6A	P18Y
BPM6F	U17Y
BPM7A	P15Y
BPM7F	U15Y
BPMR6A	PR18Y
BPMR6F	UR17Y
BPMR7A	PR15Y
BPMR7A	PR17YC
BPR4F5-11	HR19YC-1



NGK	BRISK	NGK	BRISK	NGK	BRISK
BPR5E	A-line 6	BR7ES-D	LR14C	CR7EH-9	AR14YS
BPR5E-11	A-line 38	BR7HS	NR14C	CR7EK	AR14YS
BPR5EA	A-line 9	BR7HS-10	NR14C-1	CR7EKC	AR14YS
BPR5EA-11	A-line 38	BR8ECS	LR12SL	CR7HS	NAR14YC
BPR5EA-L	LR17YC	BR8EG	LR12SL	CR7HS	NAR14YS
BPR5EA-L-11	LR17YC-1	BR8ES	LR14C	CR7HSA	NAR14YC
BPR5EFS	GR17YC	BR8EYA	LR14S	CR7HSA	NAR14YS
BPR5EFS-10	GR17YC-1	BR8HS	NR14C	CR8E	AR12YS
BPR5EP-11	LR17YP-1	BR8HS-10	NR14C-1	CR8EB	AR12YS
BPR5ES	LR17YC	BR9ECM	LR11S	CR8EH-9	AR12YS
BPR5ES-11	LR17YC-1	BR9ECS	LR11SL	CR8EHVX-9	AR12YS
BPR5EY	A-line 9	BR9EG	LR11SL	CR8EK	AR12YS
BPR5EY-11	A-line 38	BR9EG-N-8	LR11SL	CR8EVX	AR12YS
BPR5EY-D	A-line 9	BR9ES	LR12C	CR8HS	NAR12YS
BPR5EVX	LR17YP	BR9EYA	LR12SL	CR8HSA	NAR12YS
BPR5EVX-11	LR17YP-1	BR9HS	NR12C	CR9E	AR10S
BPR5HS	NR17YC	BR10ECM	LR10S	CR9EB	AR10S
BPR6E	A-line 2	BR10ECS	LR10SL	CR9EH-9	AR10S-9
BPR6E-11	A-line 10	BR10EG	LR10SL	CR9EK	AR10S
BPR6EF	A-line 7	BR10ES	LR12SL	CR9EKB	AR10S
BPR6EF-11	GR15YC-1	BR10EYA	LR12SL	CR10E	AR08S
BPR6EFIX-10	P6	BUR5EB-11	LR17YC-1	CR10EH-9	AR08S
BPR6EFIX-13P	P6	BUR5ET	LR17TC	CR10EK	AR08S
BPR6EFS	GR15YC	BUR5ET-10	LR17TC-1	D10EA	B08S
BPR6EKN	LR15TC	BUR5ETB-10	LR17TC-1	D7EA	B14C
BPR6EP-8	LR15YP	BUR6EB-11	LR15YC-1	D8EA	B12C
BPR6ES	LR15YC	BUR6ET	LR15TC	D8EVX	BR12YP
BPR6ES-11	LR15YC-1	BUR7EB-11	LR14TC-1	D9EA	B10C
BPR6EX	LR15YP	BUR7ETB-10	LR14TC-1	D9EVX	BR10YS-9
BPR6EY	A-line 2	BUR7ETB-10D	LR14TC-1	DCP6E	BR15YC
BPR6EY-11	A-line 10	C5HSA	NAR17	DCP7E	BR14YC
BPR6EY-D	A-line 2	C5HSB	NAR17	DCP8E	BR12YP
BPR6EYZ	A-line 2	C6HSA	NAR15YS	DCP8EVX	BR12YP
BPR6EV	LR15YP	C7E	AR14YS	DCPR6E	BR15YC
BPR6EVX	LR15YP	C7EH-9	AR14YS	DCPR7E	BR14YC
BPR6EVX-11	LR15YP-1	C7HA	NAR14YC	DCPR7E-A	BR14YC
BPR6FS	HR15YC	C7HA	NAR14YS	DCPR7E-N	BR14YC
BPR6H	A-line 3	C7HSA	NAR14YC	DCPR7EIX	P10
BPR6HS	NR15YC	C7HSA	NAR14YS	DCPR7EIXP	P10
BPR6HSA	NR15YC	C8E	AR12YS	DCPR8E	BR12YC
BPR7E	A-line 19	C8EH-9	AR12YS	DCPR8E-A	BR12YC
BPR7E-D	A-line 19	C8EHVX-9	AR12YS	DCPR8E-N	BR12YC-9
BPR7EFS	GR14YC	C8HA	NAR12YS	DCPR8EVX	BR12YP
BPR7ES	LR14YC	C8HSA	NAR12YS	DCPR9E	BR10YS-9
BPR7ES-11	LR14TC-1	C9E	AR10S	DCPR9EVX	BR10YS-9
BPR7EVX	LR14YP	C9EH-9	AR10S-9	DP6EA-9	BR15YC
BPR7EY	A-line 19	CMR5H	TR17	DP7EA-9	BR14YC-9
BPR7HS	NR14YC	CMR5H	TR17C	DP8EA-9	BR12YC-9
BPR8ES	LR12YC	CMR6A	SR15C	DP9EA-9	BR10YS-9
BPR8HS	NR12YC	CMR6H	TR15C	DPR6EA-9	BR15YC
BR2-LM	JR19	CMR7A	SR14C	DPR6EB-9	BR15YC
BR4-LM	JR17	CMR7H	TR14C	DPR7EA-9	BR14YC-9
BR5ES	LR17C	CMR7H	TR14S	DPR7EIX-9	P10
BR5HS	NR17C	CPR8E	AR12YS	DPR8EA-9	BR12YC-9
BR6ES	LR15C	CR5HS	NAR17	DPR9EA-9	BR10YS-9
BR6ES-D	LR15C	CR5HSA	NAR17	DR7EA	BR14S
BR6HS	NR15C	CR5HSB	NAR17	DR7EB	BR14S
BR6S	KR17C	CR6HS	NAR15YS	DR7ES	BR14S
BR7EF	GR14S	CR6HSA	NAR15YS	DR8EA	BR12S
BR7EFS	GR14S	CR7E	AR14YS	DR8EB	BR12S
BR7ES	LR14C	CR7EB	AR14YS	DR8ES	BR12S



NGK	BRISK
DR8ES-L	BR12S
DR8EVX	BR12YP
DR9EA	BR10S
DR9EVX	BR10YS-9
FR5	DR17YC-1
FR5AP-11	DR17YP-1
FR5AP-11E	DR17YP-1
FR5AP-10	DR17YP-1
FR6AP-11	DR15YP-1
FR6EI	P4
FR7AI-D	P9
GR5	A-line 38
IFR5A11	P7
IFR5D10	P7
IFR5E-11	P7
IFR5G11	P7
IFR5G-11K	P7
IFR5J11	P7
IFR5N10	P7
IFR5T11	P7
IFR6A11	P2
IFR6B	P4
IFR6B-11	P2
IFR6B-K	P4
IFR6C	P4
IFR6D10	P2
IFR6E-11	P2
IFR6G-11K	P2
IFR6J	P4
IFR6J11	P2
IFR6L-11	P2
IFR6Q-G	P4
IFR6Q-S	P4
IFR6S	P4
IFR6T-11	P2
IFR7F-8D	P9
IFR7F-8DS	P9
IFR7F-8J	P9
IFR7F-D	P9
IFR7U	P9
IFR8H-11	DOR12YS-1
IJR7A9	P10
ILFR6C-11	P3
ILFR6D-11	P3
ILFR6J-11K	P3
ILFR6T-11	P3
ILKAR7B11	P11
ILKAR7C11	P11
ILTR6E11	P5
ILZFR6A-11	P3
ILZFR6D11	P3
ILZKAR7A	P8
ILZKAR7A10	P11
ITR6F13	P6
IZFR6F-11	P1
IZFR6H-11	P1
IZFR6K-11	P1
IZFR6K-11DS	P1
IZFR6K-11E	P1
IZFR6K-11NS	P1
IZFR6K-11S	P1

NGK	BRISK
J10A	B08S
J9A	BR10S
JR10B	B08S
JR8B	BR12S
JR9B	BR10S
LFRSAP-11	ER17YP-1
LFRSB	ER17YC-9
LFRA6A-11	ER15YC-1
LFRA6AIX-11	P3
LFRA6AIX-11P	P3
LFRA6AP-11	A-line 40
LFRA6B	ER15YC-1
LFRA6C-11	ER15YC-1
LR8B	NAR12YS
LTR6IX-11	P5
LMAR9AI-8	CR10YS
LMAR9D-J	CR10YS
LMAR9E-J	CR10YS
LZKAR6AP-11	MR15LP-1
LZKAR7A	MR14LC
LZKAR7B	MR14LC
LZKR6B-10E	QR15LC-1
PFR5A-11	DR17YP-1
PFR5B	DR17YP
PFR5B-11	DR17YP-1
PFR5B-11B	DR17YP-1
PFR5B-9	DR17YP
PFR5C-11	DR17YP-1
PFR5F-11A	DR17YP-1
PFR5G-11	DR17YP-1
PFR5G-11E	DR17YP-1
PFR5J-11	DR17YP-1
PFR5K-11	DR17YP-1
PFR5L-11	DR17YP-1
PFR5N-11	DR17YP-1
PFR5P	DR17YP
PFR5P-11	DR17YP-1
PFR5R-11	DR17YP-1
PFR6A-11	DR15YP-1
PFR6A-11A	DR15YP-1
PFR6B	DR15YP
PFR6B-11	DR15YP-1
PFR6B-11B	DR15YP-1
PFR6B-11C	DR15YP-1
PFR6B-9	DR15YP
PFR6C-11	DR15YP-1
PFR6D10G	DR15YP-1
PFR6E-10	DR15YP-1
PFR6E-11	DR15YP-1
PFR6F-11A	DR15YP-1
PFR6G	DR15YP
PFR6G-9	DR15YP
PFR6G-11	DR15YP-1
PFR6H-10	DR15YP-1
PFR6J	DR15YP
PFR6J-11	DR15YP-1
PFR6K-11	DR15YP-1
PFR6L-11	DR15YP-1
PFR6M	DR15YP
PFR6N-11	DR15YP-1
PFR6P	DR15YP

NGK	BRISK
PFR6P-11	DR15YP-1
PFR6Q	DR15YP
PFR6T-G	DR15YP
PFR6T-10G	DR15YP-1
PFR6U-11G	DR15YP-1
PFR6X-11	DR15YP-1
PFR7A-11	DR14YP-1
PFR7B	DR14YP
PFR7B-11	DR14YP-1
PFR7B-11C	DR14YP-1
PFR7B-9	DR14YP
PFR7B-D	DR14YP
PFR7G	DR14YP
PFR7G-11	DR14YP-1
PFR7G-9	DR14YP
PFR7H-10	DR14YP-1
PFR7M	DR14YP
PFR7N-D	DR14YP
PFR7Q	DR14YP
PFR7S8EG	DR14YP
PFR8B	DR12YP
PFR8B-9	DR12YP
PFR8S8EG	DR12YP
PGR5A	LR17YP
PGR5A-11	LR17YP-1
PGR5C-11	LR17YP-1
PGR6A	LR15YP
PGR6A-11	LR15YP-1
PGR6C-11	LR15YP-1
PGR6D	LR15YP
PGR7A	LR14YP
PGR7A-11	LR14YP-1
PJR7A	BR14S
PJR8A	BR12S
PLFR5A-11	ER17YP-1
PLFR6A-9	A-line 40
PLFR6A-11	A-line 40
PLFR6C-10G	A-line 40
PMR7A	AR14YS
PMR8A	AR12YS
PMR8B	AR12YS
PTR5A-10	A-line 25
PTR5A-13	A-line 25
PTR5D-10	A-line 31
Ptr6F-13	P6
PZFR5D-11	DOX15LE-1
PZFR5J-11	DOX15LE-1
PZFR5Q-11	DOX15LE-1
PZFR6D-11	P1
PZFR6J-11	P1
PZFR6R	P1
PZTR5A-15	GR17LP-5
R0045Q-10	AR08GS
R0045Q-11	AR08GS
R0045G-10	AR08GS
R0045G-11	AR08GS
R0045J-10	AR08GS
R0045J-11	AR08GS
R4118S-8	LR12SL
R4118S-9	L11SL
R4118S-10	L10SL



NGK	BRISK
R4304A-9	L11SL
R4304A-10	L10SL
R5671A-8	DR12S
R5671A-9	DR10S
R5300A-10	D10IR
R5525-10	N10S
R5674-6	H15YS
R6326-10	DOR08IR
R6601-10	DR08GS
R6711-10	DR08GS
R7282-10	D10IR
R7282-10S	D08IR
R7282-11	D08IR
SIFR6A11	P2
SILFR6A11	P3
SILFR6C11	P3
SILMAR9A9S	CR10YS
SILZKAR7B11	P11
TR5	GR17YC-1
TR5GP	A-line 31
TR55	GR17YP-5
TR55GP	GR17YP-5
TR6	GR15YC-1
TR6AP-13	P6
TR6AP-13E	P6
TR6B-10	RR15YC-1
TR6GP	GR15YP-1
UR4	HR19YC-1
V-Line 1	A-line 1
V-Line 2	A-line 2
V-Line 3	A-line 3
V-Line 4	A-line 4
V-Line 5	A-line 5
V-Line 6	A-line 6
V-Line 7	A-line 7
V-Line 8	A-line 8
V-Line 9	A-line 9
V-Line 10	A-line 10
V-Line 11	A-line 11
V-Line 12	A-line 12
V-Line 13	A-line 13
V-Line 14	A-line 14
V-Line 15	A-line 15
V-Line 16	A-line 16
V-Line 17	A-line 17
V-Line 18	A-line 18
V-Line 19	A-line 19
V-Line 20	A-line 20
V-Line 21	A-line 21
V-Line 22	A-line 22
V-Line 23	A-line 23
V-Line 24	A-line 24
V-Line 25	A-line 25
V-Line 26	A-line 26
V-Line 27	A-line 27
V-Line 28	A-line 28
V-Line 29	A-line 29
V-Line 31	A-line 31
V-Line 32	A-line 32
V-Line 33	A-line 36
V-Line 34	DOX15LE-1

NGK	BRISK
V-Line 35	A-line 32
V-Line 36	A-line 32
V-Line 37	DR15YP
V-Line 38	A-line 28
V-Line 39	A-line 36
ZF6A-11	DR15LC-1
ZFR5A-11	DR17LC-1
ZFR5F	DR17LC
ZFR5F-11	DR17LC-1
ZFR5G	DR17LDC
ZFR5J-11	DR17LC-1
ZFR5P-G	DOX15LE-1
ZFR6A-11	DR15LC-1
ZFR6D-11	DOX15LE-1
ZFR6E-11	DOX15LE-1
ZFR6F	DR15LC
ZFR6F-11	DR15LC-1
ZFR6F-11G	DR15LC-1
ZFR6FIX11	P1
ZFR6FIX11P	P1
ZFR6J-11	DR15LC-1
ZFR6K-11	DOX15LE-1
ZFR6P-G	DOX15LE-1
ZFR6T-11G	DOX15LE-1
ZFR7F	A-line 33
ZFR7F-11	A-line 34
ZFR7J-11	A-line 34
ZGR5A	A-line 15
ZGR6A	A-line 2
NHSP LD	BRISK
A6RTC	NAR15YS
A6RTC1	NAR15YS
A6TC	NAR15YS
A7RTC	NAR14YC
A7TC	NAR14YC
A8RTC	NAR12YS
A8TC	NAR12YS
B7RC	AR14YS
B8RC	AR12YS
C7E	AR14YS
CR7E	AR14YS
C8E	AR12YS
CR8E	AR12YS
C9E	AR10S
CR9E	AR10S
D7	B14C
D7CA	B14C
D7RC	BR14S
D7RTC	BR14YC-9
D7TC	BR14YC-9
D8C	B12C
D8RC	BR12S
D8RTC	BR12S
D8TC	B12C
DF7REC2	BR14YC-9
DK7RTC	BR14YC
E5T	N17YC
E5TC	N17YC
E5RTC	NR17YC
E6TC	N15YC
E7TC	N14YC

NHSP LD	BRISK
E8C	N14C
E8RC	NR14C
E8RTC	NR12YC
E8TC	N12YC
F7C	L14C
F8C	L14C
F5RTC	LR17YC
F5TC	L17YC
F6RTC	LR15YC
F6TC	L15YC
F6TJC	LR15TC
F7RC	LR14C
F7RTC	LR14YC
F7TC	L14YC
F8RC	LR14C
G4C	K19
G6	K17C
G6C	K17C
K5RTC-11	DR17YC-1
K6EPPOR	DR15YP-1
K6RKCX	DR17LC-1
K6RKDC	DR17LDC
K6RLCX	A-line 36
K6RTC	DR17YC
K6TC	D17YC
K6TJC	DR17TC
K7RLC	A-line 28
K7RLCX	A-line 14
K7RTC	DR15YC
K7RTCX	A-line 11
K7RTDC	DR15LDC
K7RTJC	DR15TC
K7TC	D15YC
K7TJC	DR15TC
K7YKJCR	DR15TC
K8RTJC	DR14TC
KH6RKC3	ER15YC-1
L6	P17
L6T	P17Y
L7	P15
L7T	P15Y
L8RTF	PR17Y
N6	U17
N9	U15
P5TC	HR17YC
P5RTC	HR17YC
P6TC	HR15YC
P6RTC	HR15YC
P7TC	HR14YS
P7RTC	HR14YS
Q5RTC	GR17YC
Q5TC	G17YC
Q6RTC	GR17YC
Q6TC	G17YC
Q7TC	G15YC
T1137C	NAR14YC
T1137C	NAR14YS
T5RTC	FR17YC
T5TC	F17YC
T6RTC	FR15YC
T6TC	F15YC



NISSAN	BRISK
22401-00Q0A	DR15YP
22401-01B14	LR17YC-1
22401-01P15	DR17YC-1
22401-01P16	DR15YC-1
22401-01P17	DR14YC-1
22401-01P75	DR17YC-1
22401-01P76	DR15YC-1
22401-01P90	DR17YC-1
22401-01P91	DR15YC-1
22401-02P15	DR17YC-1
22401-02P16	DR15YC-1
22401-02P17	DR14YC-1
22401-08U15	DR17YP-1
22401-08U75	DR17YP-1
22401-0P615	DR17YP-1
22401-0P616	DR15YP-1
22401-0P675	DR17YP-1
22401-0P676	DR15YP-1
22401-10F15	D17YC
22401-10F16	D15YC
22401-10F17	D14YC
22401-10P15	A-line 36
22401-10P16	A-line 14
22401-10P17	A-line 34
22401-12E15	DR17YC
22401-12E16	DR15YC
22401-12E17	DR14YC
22401-12E76	DR15YC
22401-18V15	LR17YP
22401-18V16	LR15YP
22401-18V17	LR14YP
22401-19V15	D17YC
22401-19V16	D15YC
22401-19V17	D14YC
22401-19V65	DR17YC
22401-19V66	DR15YC
22401-1F720	A-line 36
22401-1N506	A-line 28
22401-1N516	A-line 28
22401-1N567	DR14YP-1
22401-1P115	DR17YP-1
22401-1P116	DR15YP-1
22401-1P117	DR14YP-1
22401-1P175	DR17YP-1
22401-1P175-Q0	DR17YP-1
22401-1P175-VA	DR17YP-1
22401-1P176	DR15YP-1
22401-1P176-VA	DR15YP-1
22401-1P176-WS	DR15YP-1
22401-1W615	DR17YP-1
22401-1W616	DR15YP-1
22401-1W675	DR17YP-1
22401-20J05	A-line 32
22401-20J05-Q0	A-line 32
22401-20J05-SN	A-line 32
22401-20J05-VA	A-line 32
22401-20J05-W0	A-line 32
22401-20J06	A-line 28
22401-20J07	A-line 33
22401-20J16	A-line 28
22401-21B15	A-line 6

NISSAN	BRISK
22401-21B16	A-line 2
22401-21B17	A-line 19
22401-27N15	DR17YP-1
22401-27N15-VA	DR17YP-1
22401-27N15-VB	DR17YP-1
22401-27N16	DR15YP-1
22401-27N65	DR17YP-1
22401-27N66	DR15YP-1
22401-27N67	DR14YP-1
22401-27T15	DR17YP-1
22401-27T65	LR17YP-1
22401-27T66	LR15YP-1
22401-2J200	A-line 36
22401-2J200-Q0	A-line 36
22401-2J200-VA	A-line 36
22401-2J206	A-line 14
22401-2J206-VA	A-line 14
22401-30R15	DR17LC-1
22401-30R16	DR15LC-1
22401-30R75	DR17LC-1
22401-30R75-W1	DR17LC-1
22401-37P15	DR17YP-1
22401-37P16	DR15YP-1
22401-37P76	DR15YP-1
22401-40P15	DR17YP-1
22401-40P65	DR17YP-1
22401-40P66	DR15YP-1
22401-40V05	A-line 16
22401-40V06	A-line 17
22401-40V07	A-line 33
22401-50Y05	A-line 36
22401-50Y05-Q0	A-line 36
22401-50Y05-VA	A-line 36
22401-50Y05-W0	A-line 36
22401-50Y06	A-line 11
22401-50Y07	A-line 34
22401-50Y75	A-line 36
22401-50Y75-W0	A-line 36
22401-53J05	A-line 32
22401-53J06	A-line 28
22401-53J06-RB	A-line 28
22401-53J06-VA	A-line 28
22401-53J07	A-line 33
22401-53J15	DR15YP
22401-53J15	DR17YP
22401-53J65	DR17YP
22401-53J66	DR15YP
22401-53J67	DR14YP
22401-53V15	DR17YP
22401-53V16	DR15YP
22401-53V17	DR14YP
22401-55V17	DR14YP
22401-58S15	DR17YP-1
22401-58S16	DR15YP-1
22401-58S17	DR14YP-1
22401-59S16	DR15YP-1
22401-5M015	ER17YP-1
22401-5M016	A-line 40
22401-5M075	ER17YP-1
22401-5M075-Q0	ER17YP-1

NISSAN	BRISK
22401-5M075-SN	ER17YP-1
22401-5M075-VA	ER17YP-1
22401-5M075-W0	ER17YP-1
22401-60V06	DR15YC-1
22401-85E15	DR17YC-1
22401-85E16	DR15YC-1
22401-85E17	DR14YC-1
22401-85E75	DR17YC-1
22401-85E76	DR15YC-1
22401-88G75	A-line 32
22401-88G75-WS	A-line 32
22401-88G76	A-line 28
22401-88G76-WS	A-line 28
22401-8H315	ER17YP-1
22401-8H375	ER17YP-1
22401-8H375-VA	ER17YP-1
22401-8H516	ER15YC-1
22401-8H616	A-line 40
22401-8H676	A-line 40
22401-97E15	DR17YP-1
22401-97E65	DR17YP-1
22401-98E06	DR15YC-1
22401-9E075	DR17YP-1
22401-AG215	DR17YP-1
22401-AG275	DR17YP-1
22401-AJ415	DR17YP-1
22401-ED51C	P11
22401-ED816	P11
22401-F6516	DR15YP-1
22401-M7915	LR17C
22401-M7916	LR15C
22401-N8715	LR17YC-1
22401-N8716	LR15YC-1
22401-N8717	LR14TC-1
22401-N8785	LR17YC-1
22401-N8786	LR15YC-1
22401-N8789	LR15YC-1
22401-N8790	LR17YC-1
22401-N8791	LR15YC-1
22401-P8315	LR17YC-1
22401-P8316	LR15YC-1
22401-P8317	LR14TC-1
22401-P8385-PC	LR17YC-1
22401-P8386-PC	LR15YC-1
22401-P8390	LR17YC-1
22401-P8391	LR15YC-1
22401-V0515	L17YC
22401-V0516	L15YC
22401-V1415	LR17YC
22401-V1416	LR15YC
22401-V1417	LR14YC
22401-V1485-PC	LR17YC
22401-V1486-PC	LR15YC
22401-V1490	LR17YC
22401-V1491	LR15YC
22401-V5015	DR17YC-1
22401-V5016	DR15YC-1
22401-V5017	A-line 34
22401-V5085	DR17YC-1
22401-V5086	DR15YC-1
22401-VB000	A-line 38



NISSAN	BRISK	OMC	BRISK	OREGON	BRISK
22401-VB006	A-line 10	584918	BR14YC	77-301-1	J19
22401-W8915	L17YC	OEPEL	BRISK	77-302-1	P17
22401-W8915-SA	L17YC	09 195 109	DR17LDC	77-303-1	DR17YC
22401-W8916	L15YC	12 787 099	DR15YP-1	77-304-1	U17
22401-W8917	L14YC	12 788 884	A-line 40	77-305-1	JR19
22401-W8985	L17YC	12 14 000	DR17LDC	77-306-1	PR17
22401-W8985-PC	L17YC	12 14 003	DR15LDC	77-307-1	PR15Y
22401-W8986	L15YC	12 14 005	DR17LDC-1	77-308-1	P15
22401-W8986-PC	L15YC	12 14 011	DR15LDC	77-309-1	P18Y
22401-W8990	L17YC	12 14 015	DR15LDC	77-310-1	L17YC
22401-W8991	L15YC	12 14 026	DR15YP	77-311-1	P15Y
22401-W9815	LR17YC	12 14 029	DR15YP	77-312-1	LR15YC
22401-W9816	LR15YC	12 14 030	DR15YP-1	77-313-1	J17
22401-W9817	LR14YC	12 14 046	DR15YP	77-314-1	LR17YC-1
22401-WA016	DR15YP	12 14 060	DR15YP-1	77-315-1	L15YC
22401-WA066	DR15YP	12 14 139	LR15YC	77-316-1	U15
22401-WA067	DR14YP	12 14 141	DR15LDC	77-317-1	K19
22401-Y9015	DR17TC	12 14 149	LR17YC	77-318-1	U17Y
22401-Y9016	DR15TC	12 14 193	LR15YC	77-319-1	PR18Y
22401-Y9017	DR14TC	12 14 455	DR17LDC-1	77-320-1	NR17YC
22401-Y9065	DR17TC	12 14 527	A-line 40	77-321-1	N17C
22401-Y9066	DR15TC	12 14 807	LR15YC	77-323-1	L14C
22401-Y9067	DR14TC	32 025 875	DR17LDC-1	77-324-1	PR17Y
22401-Y9215	LR17YC	44 10 220	DR15YP	77-325-1	NR15YC
22401-Y9265	L17YC	44 13 288	DR15YP	77-350-1	JR17
22401-Y9266	L15YC	55 562 534	DR15YP	77-351-1	K17C
22401-ZH015	ER17YP-1	55 571 391	DR15YP-1	77-352-1	N17YC
B2401-89904	A-line 8	90 239 568	LR15YC	77-354-1	PR15
B2401-89905	A-line 4	90 239 569	NR15YC	77-355-1	TR15C
B2401-89906	P7	90 297 143	NR15YC	77-400	J19
B2401-89907	DR15YP-1	90 336 461	DR15YC	77-401	LR15YC
B2401-89908	A-line 9	90 338 179	DR15TC	77-402	P18Y
B2401-89909	A-line 2	90 350 018	LR15YC	77-403	L17YC
B2401-M7915	LR17C	90 355 136	LR15YC	77-404	P17
B2401-V1415	LR17YC	90 356 323	LR17YC	77-405	P17Y
B2401-V1416	LR15YC	90 357 729	DR15LDC	77-406	N17C
B2401-W8915	L17YC	90 357 780	DR15YC	77-407	P15Y
B2401-W8916	L15YC	90 423 215	DR15YC	77-408	LR17YC-1
B2401-W8917	L14YC	90 442 650	DR15LDC	77-409	P15
BY480-BKR6E	P4	90 444 723	DR17LDC-1	77-410	J17
BY481-BCPR5	P7	90 512 989	DR17LDC	77-411	U17
BY481-BCPR6	P2	90 541 059	DR15LDC	77-412	U15
BY481-BKR5E	P7	90 542 918	DR15LDC	77-413	U17Y
BY481-BKR6E	P2	90 462 939	DR17LDC-1	77-414	PR17Y
BY481-LFR6A	P3	90 588 129	DR17LDC-1	77-415	PR15Y
BY481-ZFR6F	P1	91 132 006	DR17LDC-1	77-416	JR19
BY483-BCPR5	P7	91 132 086	DR15LDC	77-417	PR17
BY483-BCPR6	P2	91 463 67	DR15LDC	77-455	TR15C
BY483-BKR5E	P7	91 463 69	DR17LDC-1	O-DR17YC	DR17YC
OMC	BRISK	91 95 109	DR17LDC	O-J17	J17
115206	N15YC	92 70 293	DR15YP	O-J19	J19
387694	N14C	93 160 201	DR15YP	O-JR17	JR17
437929	NR14YC	93 161 199	DR15YP	O-JR19	JR19
502177	N15C	93 175 994	DR15YP	O-K17C	K17C
502194	N14C-1	93 176 801	DR17LC	O-K19	K19
503948	NR15YC	93 180 485	DR17LC	O-L15YC	L15YC
503949	NR15C	93 188 550	LR17YC	O-L17YC	L17YC
503950	NR15C	OREGON	BRISK	O-LR15YC	LR15YC
504082	NR15C	77-012	U15	O-LR17YC	LR17YC
509928	K17C	77-032	LR14C	O-NR15YC	NR15YC
509929	N14C	77-300-1	P17Y	O-N17C	N17C



OREGON	BRISK	PRESTOLITE	BRISK	PSA	BRISK
O-N17YC	N17YC	14G22	L15YC	5962 4A	DR15LDC
O-P15	P15	14G3	L15C	5962 5F	DR15YC-9
O-P15Y	P15Y	14G32	L17YC	5962 5Z	NR15YC
O-P17	P17	14G4	L15C	5962 71	DR15YC
O-P17Y	P17Y	14G42	L17YC	5962 72	G15YC
O-P18Y	P18Y	14G5	L17C	5962 80	N15YC
O-PR15	PR15	14G52	L17YC	5962 82	L15YC
O-PR15Y	PR15Y	14G7	L17C	5962 87	G15YC
O-PR17	PR17	14G902	L12YC	5962 88	L12YC
O-PR17Y	PR17Y	14GF22	G15YC	5962 90	N15YC
O-PR18Y	PR18Y	14GR22	LR15YC	5962 94	L14YC
O-U15	U15	14GR32	LR17YC	5962 98	L14YC
O-U17	U17	14GR4	LR15C	5962 A1	L14YC
PEUGEOT = PSA	BRISK	14GR42	LR17YC	5962 A2	L15YC
PORSCHE	BRISK	14GR7	LR17C	5962 A3	N15YC
999 170 141 90	LR15YC	14GRF22	GR15YC	5962 AO	L14YC
999 170 142 90	LR15YC	14GRF32	GR17YC	5962 C5	DR15YC
999 170 158 90	LR15YC	14GRF52	GR17YC	5962 C6	DR15YC
999 170 199 90	DR15LDC	14R32	K17Y	5962 CO	G17YC
PRESTOLITE	BRISK	14R42	K17Y	5962 F3	NR15YC
10E2	NAR14YC	14R7N	P17	5962 F4	NR15YC
10E3	NAR14YC	14R8	KR17C	5962 F7	D15YC
10E4	NAR15YS	14RF22	HR15YC	5962 F8	D15YC
12G2	B12C	14RF32	HR17YC	5962 G8	L14YC
12G3	B12C	14RF42	HR17YC	5962 H2	DR15YC
14-11N	P18Y	18F22	F15YC	5962 H8	DR17YC
14-2X	K17C	18F3	FR15C	5962 H9	DR17YC
14-3	K17C	18F32	F15YC	5962 IA	LR17TC
14-32	K17Y	18F42	F17YC	5962 IK	DR15LDC
14-3N	P15	18F6	FR15C	5962 IL	DR17LDC
14-3X	K17C	18F82	F17YC	5962 J9	DR15YC
14-4	K17C	18RF3	FR15C	5962 JO	D15YC
14-42	K17Y	18RF32	FR15YC	5962 K1	DR14YC
14-5	K17C	18RF42	FR15YC	5962 K3	DR14TC
14-52	K17Y	18RF82	FR15YC	5962 K4	DR15YC
14-5X	K17C	PROTECNICA	BRISK	5962 K6	DR15YC
14-7	K19	4708	JR17	5962 K7	DR15TC
14-7N	P17	4843	P15Y	5962 KO	DR14YC
14-7X	K19	PSA	BRISK	5962 N9	NR15YC
14-9	K19	1173702700	NR17YC	5962 OE	DR15LDC
14-9X	K19	5960 55	MR14LC	5962 Q9	DR15LDC
14E1	N14C	5960 56	MR14LC	5962 R3	DR15LDC
14E2	N14C	5960 83	MR14LC	5962 R5	DR15TC
14E22	N14YC	5960 84	MR14LC	5962 R9	DR15YC
14E3	N15C	5960 F1	DR15LDC	5962 S2	DR15YC
14E32	N15YC	5960 G1	MR14LC	5962 S4	DR17YC
14E4	N17C	5960 J7	DR15LDC	5962 S7	L17YC
14E42	N15YC	5962 00	D15YC	5962 T8	DR15YC
14E52	N17YC	5962 05	G15YC	5962 TO	DR15YC
14E6	N17C	5962 09	G15YC	5962 V6	DR17YC
14E62	N17YC	5962 13	L15YC	5962 V7	DR15YC
14ER4	NR15C	5962 14	G15YC	5962 V8	DR14YC
14ER6	NR15C	5962 15	G15YC	5962 W1	DR17YC
14F22	HR15YC	5962 16	L15YC	5962 W4	DR15TC
14F32	HR15YC	5962 21	LR15TC	5962 W6	DR14YC
14F3N	U15	5962 22	LR15YP	5962 W7	DR14YC
14F42	HR17YC	5962 2A	LR15YC	5962 W9	DR17LDC
14F7N	U17	5962 2J	DR15LDC	5962 X5	D15YC
14G1	L14C	5962 2K	DR15LDC	5962 X8	D15YC
14G12	L12YC	5962 2T	DR15LDC	5962 Y2	DR17LDC
14G2	L14C	5962 2X	DR15YC	5962 Y8	DR15LDC



PSA	BRISK
5962 Y9	DR15LDC-1
5962 Z1	DR15LDC
5962 Z3	DR15LDC
5962 Z6	DR17LDC
5962 Z0	DR15LDC
7343 71	NR14C
7355 92	NR15YC
7369 54	NR14C
7369 75	AR14Y5
7370 27	NR17YC
7381 55	LR14C
7423 80	AR14Y5
7443 61	AR12Y5
7540 50	LR12C
7567 56	BR14YC-9
7567 57	N15C
7567 58	N17YC
7567 59	N14C
7567 60	N14C
7567 61	N15YC
7567 62	LR12C
7567 63	N12C
7567 66	L14C
95 496 692	N15YC
95 611 941	G15YC
95 618 380	NR15YC
95 619 043	L15YC
96 000 090	D17YC
96 037 952	D17YC
96 039 962	DR15TC
96 064 890	DR17YC
96 097 486	DR14TC
96 145 071	DR15TC
96 147 386 80	DR15LDC
96 265 754	DR15LDC
96 629 591 80	DR17LDC-1
97 533 994	G14YC
CPC 12	NR15YC
DV 212 207 A	NR15YC
DX 212 7 A	NR15YC
DX 212 7 C	NR15YC
MKP 000 73	L14YC
MKP 000 94	NR15YC
ZC 986 209 0U	L17YC
ZCT 000 011	N15YC
ZCT 000 012	L14YC
RENAULT	BRISK
74 39 146 775	DR17TC
77 00 100 403	DR15LDC
77 00 101 401	DR17YC
77 00 103 502	LR17YC
77 00 103 503	LR17YC
77 00 103 533	DR17LDC
77 00 107 916	DR17LDC
77 00 109 403	DR15LDC
77 00 115 827	DR15LDC
77 00 260 637	DR14TC
77 00 266 295	GR15YC
77 00 267 140	GR15YC
77 00 273 462	DR15YC
77 00 273 698	DR15YP

RENAULT	BRISK
77 00 500 096	DR15LDC
77 00 500 155	DR15YC-9
77 00 500 168	DR15LDC
77 00 500 252	DR15LDC
77 00 553 622	L15YC
77 00 587 168	N15YC
77 00 681 298	LR15YC
77 00 714 540	GR15YC
77 00 722 095	G15YC
77 00 724 821	L15YC
77 00 725 302	LR17YC
77 00 726 503	G14YC
77 00 727 383	LR15YC
77 00 731 583	G14YC
77 00 732 626	L12YC
77 00 733 422	N17YC
77 00 736 149	G14YC
77 00 736 150	G14YC
77 00 737 457	G14YC
77 00 737 458	G15YC
77 00 737 459	L14YC
77 00 737 612	D17YC
77 00 742 094	LR14YC
77 00 743 137	D15YC
77 00 743 920	L17YC
77 00 749 163	D17YC
77 00 824 821	L15YC
77 00 852 522	G15YC
77 00 855 463	DR15TC
77 00 855 918	G15YC
77 00 856 342	DR15TC
77 00 859 910	D17YC
77 00 859 967	L17YC
77 00 860 235	L17YC
77 00 861 471	L14YC
77 00 861 472	L15YC
77 00 862 054	L17YC
77 00 868 864	LR14YC
77 00 869 200	D17YC
77 00 871 617	DR15TC
77 01 021 767	G15YC
77 01 041 214	L17YC
77 01 041 215	G15YC
77 01 042 816	DR15YC
77 01 043 624	DR15TC
77 01 045 018	G14YC
77 01 366 057	N15YC
77 01 366 086	L15YC
77 01 366 087	L14YC
77 01 366 137	G15YC
77 01 366 267	N15YC
77 01 366 268	L17YC
77 01 366 269	L15YC
77 01 366 270	G15YC
77 01 366 513	N17YC
77 01 366 514	G15YC
77 01 366 515	N15YC
77 01 366 516	L15YC
77 01 366 539	L17YC
77 01 366 903	L17YC
77 01 414 022	N17YC

RENAULT	BRISK
77 01 414 025	L15YC
77 01 414 026	G14YC
77 01 414 027	G14YC
77 01 414 031	LR15YC
77 01 414 105	L17YC
77 01 414 113	LR15YC
77 01 414 142	LR15YC
82 00 020 791	A-line 28
82 00 027 363	DR17LDC
82 00 030 765	MR14LC
82 00 046 337	DR15YP
82 00 239 321	DR15YP-1
82 00 314 928	DR14YP
82 00 332 215	MR14LC
82 00 332 273	MR14LC
82 00 363 364	DR15YP
82 00 363 384	DR15YP
82 00 592 215	MR14LC
82 00 662 185	MR14LC
83 04 504 277	DR17LC
89 33 003 862	DR15YC
96 26 575 480	DR15LDC
96 32 182 880	DR15YP-1
ROLLS ROYCE	BRISK
RH13998	DR17YP
ROVER	BRISK
GSP2001	DR15YP
GSP665	DR15YP
GSP9652	DR15YP
NLP000040	DR15YP
NLP100260	A-line 2
NLP100290	DR15YP-1
SAAB	BRISK
12 787 099	DR15YP-1
12 788 884	A-line 40
15 885 210	DR14YC-1
30 520 467	DR15YC-1
32 000 330	DR14YC-1
44 447 41	DR15LDC
931 88 564	DR15LDC
45 718 08	DR14YP-1
55 571 391	DR15YP-1
56 924 85	DR14YP
59 587 80	DR17YP
59 587 98	DR17YP
88 193 02	DR14YP
91 125 41	DR14YC-1
91 163 85	D17YC
91 175 65	DR15YC-1
91 362 76	DR17YP
91 396 43	DR15YP
91 713 07	DR14YC-1
91 853 98	DR14YP-1
91 886 81	DR14YP-1
91 951 09	DR17LDC
93 998 66	DR15YP-1
SCANIA	BRISK
320 258 74	DR15LDC
320 258 75	DR17LDC-1
4444741	DR17LDC-1
4501029	DR15LDC



SEAT = VW GROUP	BRISK
SKODA = VW GROUP	BRISK
SMART = MERCEDES	BRISK
SOLO	BRISK
2300730	PR15Y
2300743	PR18Y
2300888	TR14C
2300888	TR14S
SSANGYONG	BRISK
162 159 3103	DR15LDC
SUBARU	BRISK
09019 01211	DR15YP
22401 AA000	LR17YC-1
22401 AA010	LR15YC-1
22401 AA020	L15YC
22401 AA030	L15YC
22401 AA080	A-line 4
22401 AA090	L14YC
22401 AA120	LR15YC-1
22401 AA130	LR15YC-1
22401 AA200	LR15YC
22401 AA210	LR14YC
22401 AA220	LR15YC
22401 AA230	A-line 19
22401 AA310	A-line 14
22401 AA320	A-line 14
22401 AA360	DR14YP
22401 AA370	DR15YP-1
22401 AA400	DR15YP
22401 AA460	A-line 38
22401 AA470	A-line 10
22401 AA480	LR17YC-1
22401 AA500	DR15YP-1
22401 AA510	DR15YP
22401 AA520	DR15YP-1
22401 AA530	DR15YP
22401 AA531	DR15YP
22401 AA570	DR17YP-1
22401 AA580	A-line 40
22401 AA600	DR14YP
22401 AA610	P1
22401 AA630	P3
22401 AA650	DR17YP-1
22401 AA65A	DR17YP-1
22401 AA680	P3
22401 AA700	P3
22401 AA720	P3
22401 AA730	P2
22401 AA750	P3
22401 AA760	P4
22401 KA010	A-line 11
22401 KA030	A-line 14
22401 KA080	A-line 28
22401 KA090	A-line 12
22401 KA100	A-line 12
22401 KA130	LR15YC
22401 KA150	A-line 28
22401 KA190	A-line 38
22401 KA200	A-line 36
22401 KA210	A-line 36
22401 KA240	BR14YC
22401 KA260	BR14YC

SUBARU	BRISK
22401 KA310	BR12YC
22401 KA320	BR12YP
22401 KA440	A-line 32
32054 5700	LR15C
38028 0102	A-line 4
42054 3200	L17YC
42054 5502	L15YC
42054 5602	A-line 38
42054 5702	A-line 10
42054 7102	A-line 8
42054 7302	A-line 8
49001 0003	LR17YP
49001 0013	LR15YP
49001 0033	LR17YC
49001 0043	A-line 8
49001 0053	A-line 4
49001 0082	A-line 9
49001 0092	A-line 2
88241 7800	N17C
901901211	DR15YP
SAB330DE0710	P7
SAB330DE2640	P3
SAB330DE3360	P7
SAB330DE3370	P2
SAB330DE3430	P10
SAB330DE3710	P7
SAB330DE5140	P3
SAB330DE8640	P7
SAB330DE8680	P7
SAB330DE8690	P2
SAB330DE8720	P10
SUZUKI	BRISK
09482-00210	L10SL
09482-00478	L10SL
09482-00054	L15C
09482-00095	N15C
09482-00089	L14C
09482-00082	N14C
09482-00208	L11S
09482-00091	L14C
09482-00198	N14C
09482-00278	N14C
09482-00375	N14C
09482-00209	L10S
09482-00066	LR12C
09482-00477	DR17YC-1
09482-00427	A-line 12
09482-00494	A-line 11
09482-00131	L17YC
09482-00287	LR17YC-1
09482-00124	N17YC
09482-00118	L15YC
09482-00084	N15YC
09482-00139	L14YC
09482-00385	L14YC
09482-00105	N14YC
09482-00175	LR12YC
09482-00258	PR18Y
09482-00432	LR17YC
09482-00493	A-line 38
09482-00155	LR17YC

SUZUKI	BRISK
09482-00433	A-line 38
09482-00147	NR17YC
09482-00316	NR17YC
09482-00359	NR17YC
09482-00299	LR15YC
09482-00141	NR15YC
09482-00409	LR15YC
09482-00487	LR15YC
09482-00530	NR15YC
09482-00255	NR14YC
09482-00239	LR12YC
09482-00121	LR14C
09482-00349	LR12C
09482-00516	AR14VS
09482-00456	AR12YS
09482-00412	AR12YS
09482-00458	AR10S
09482-00410	AR10S
09482-00182	BR14S
09482-00144	BR12S
09482-00184	BR10S
09482-00369	BR14YC
09482-00386	BR14S
09482-00379	BR12YP
09482-00384	BR12YP
09482-00446	BR15YC
09482-00448	BR14YC
09482-00479	BR14YC
09482-00450	BR12YP
09482-00481	BR12YP
09482-00537	BR10YS
09482-00332	BR12YP
09482-00354	BR14YC
09482-00334	BR12YP
09482-00330	BR10YS-9
09482-00399	BR12S
09482-00400	BR10S
09482-00547	DR17YP-1
09482-00549	DR17YP-1
09482-00548	DR15YP-1
09482-00397	BR10S
09482-00521	LR17YP
09482-00362	LR17YP
TALBOT	BRISK
00 00 VSP 118	LR15YC
00 792 270 42	LR15YC
TORCH	BRISK
1137	NAR15YS
2197	B14C
4104J	K19
4106J	K17C
4137J	N15C
4138J	N14C
4139J	N14C
4197J	L15C
4198J	L14C
5580	LR15TC
8012	LR15YP
A4106	P17
A5RTC	NAR17
A6RTC	NAR15YS



TORCH	BRISK
A6TC	NAR15YS
A7T	NAR14YC
A7T	NAR14YS
A7TC	NAR14YC
A7TC	NAR14YS
A7RTC	NAR14YC
A7RTC	NAR14YS
A8RTC	NAR12YS
A8TC	NAR12YS
AC7R	TR14C
AC7R	TR14S
B7C	AR14YS
B7RTC	AR14YS
B7RD	AR14YS
B7TC	AR14YS
B8R	AR12YS
B8RC	AR12YS
B8RH	AR12YS
BR7C	AR14YS
CMR7H	TR14C
CMR7H	TR14S
D7	B14C
D7C	B14C
D7CA	B14C
D7TC	BR14YC
D7RC	BR14S
D7RTC	BR14YC
D7RTC9	BR14YC-9
D8C	B12C
D8RC	BR12S
D8RTC	BR12YC
D8T	BR12YC
D8TC	BR12YC
DJ7Y	U15Y
DJ8J	U17
DK7RTC	BR14YC
E5RTC	NR17YC
E5T	N17YC
E5TC	N17YC
E6C	N15C
E6RC	NR15C
E6RTC	NR15YC
E6T	N15YC
E6TC	N15YC
E7C	N14C
E7RTC	NR14YC
E7TC	N14YC
E8RC	NR14C
E8RTC	NR12YC
F5C	L17C
F5RF	A-line 9
F5RTC	LR17YC
F5T	L17YC
F5TC	L17YC
F5RTP	LR17YP
F5RTPP	LR17YP
F6C	L15C
F6RC	LR15C
F6RF	A-line 2
F6RTC	LR15YC
F6RTJC	LR15TC

TORCH	BRISK
F6RTJY	LR15TC
F6RTP	LR15YP
F6RTPP	LR15YP
F6T	L15YC
F6TC	L15YC
F7C	L14C
F7RC	LR14C
F7RTC	LR14YC
F7RTJC	LR14TC
F7RTP	LR14YP
F7RTPP	LR14YP
F7TC	L14YC
F7TJC	LR14TC
F8RC	L14C
F8RTC	LR12YC
G3F	K19
G4C	K19
G4RC	K19
G5RC	KR17C
G6C	K17C
G6RC	KR17C
GL3	J19
GL3R	JR19
GL4	J17
GL4C	J17
GL4RC	JR17
K4RTC3	DR17LC
K5RF-11	A-line 36
K5RTC-11	DR17YC-1
K5TC	D17YC
K5RTJC	DR17TC
K5RTP	DR17YP
K5RTPP	DR17YP
K5RTS	DR17YS
K6RA	A-line 12
K6RB-11	DR15LC-1
K6RD	DR15LDC
K6RDY	DR15LDC
K6RF	A-line 28
K6RF-11	A-line 11
K6RTC	DR15YC
K6RTC-11	DR15YC-1
K6RTIP	P4
K6RTJY	DR15TC
K6RTMIP	A-line 40
K6RTMPP	A-line 40
K6RTP	DR15YP
K6RTPP	DR15YP
K6TC	D15YC
K7RTC	DR14YC
K7TC	D14YC
K7TJC	DR14TC
K7RTIP	P9
K7RTP	DR14YP
K7RTPP	DR14YP
L6	P17
L6C	P17
L6RC	PR17
L6RTC	PR18Y
L6T	P18Y
L6TC	P18Y

TORCH	BRISK
L7	P15
L7RC	PR15
L7RTC	PR15Y
L7T	P15Y
L7TC	P15Y
L7Y	P15
L8RT	PR15Y
L9	P15
L9T	P15Y
LD7RTC	MR14LC
LD7RTIP	P8
LD7RTP	P8
LD7RTPP	P8
N6	U17
N6C	U17
N6RC	UR17
N6RTC	UR17Y
N6TC	U17Y
N7C	U15
N7RC	UR15
N9	U15
P5RTC	HR17YC
P5TC	HR17YC
P6RTC	HR15YC
P6TC	HR15YC
P7RTC	HR14YS
P7TC	HR14YS
Q5RTC	GR17YC
Q5TC	G17YC
Q6RTC	GR15YC
Q6RTIP	P6
Q6RTPP	GR15YP-1
Q6TC	G15YC
Q7TC	G14YC
QH6RTC	RR15YC-1
QH6RTIP	P5
QH6RTPP	A-line 25
RDJ8J	UR17
T1136	NAR15YS
T1137	NAR14YC
T1137	NAR14YS
T1137C	NAR14YC
T1137C	NAR14YS
T2197	B14C
T2198	B12C
T4135J	N17YC
T4136J	N17YC
T4137J	N15YC
T4138J	N14YC
T4195J	L17YC
T4196J	L17YC
T4197J	L15YC
T4198J	L14YC
T5C	FR15C
T5RC	FR15C
T5TC	F17YC
T6RTC	FR15YC
T6TC	F15YC
TOYOTA	BRISK
90080-91145	DR17LDC-1
90919-01059	A-line 8



TOYOTA	BRISK
90919-01064	A-line 9
90919-01083	A-line 4
90919-01084	A-line 2
90919-01087	LR17TC
90919-01090	LR17TC
90919-01091	A-line 38
90919-01094	A-line 38
90919-01095	LR17TC
90919-01098	A-line 2
90919-01102	A-line 9
90919-01104	A-line 38
90919-01115	LR17YP-1
90919-01116	LR17YP-1
90919-01121	DR17YP-1
90919-01122	DR17YP-1
90919-01125	A-line 10
90919-01126	A-line 10
90919-01127	DR15YP-1
90919-01128	DR15YP-1
90919-01129	A-line 36
90919-01131	A-line 11
90919-01136	DR15YP-1
90919-01139	A-line 10
90919-01143	LR17YP-1
90919-01144	LR17YP-1
90919-01145	DR15YP
90919-01146	DR15YP
90919-01147	LR15YP
90919-01148	LR15YP
90919-01149	A-line 12
90919-01151	DR17YP
90919-01152	DR17YP
90919-01153	A-line 32
90919-01159	A-line 36
90919-01164	A-line 36
90919-01165	A-line 36
90919-01166	A-line 28
90919-01168	DR17YP-1
90919-01169	DR17YP-1
90919-01172	DR15YP
90919-01173	DR15YP
90919-01176	A-line 32
90919-01177	A-line 32
90919-01178	DR15YP-1
90919-01179	DR15YP-1
90919-01180	DR15YP
90919-01181	DR15YP
90919-01184	A-line 14
90919-01185	A-line 14
90919-01191	P3
90919-01192	DR17LDC-1
90919-01193	DR17LDC-1
90919-01195	DR15LDC-1
90919-01198	DR15LDC-1
90919-01202	DR15LDC-1
90919-01205	DR17YP
90919-01206	DR17YP
90919-01207	P2
90919-01210	P2
90919-01211	P2
90919-01217	P7

TOYOTA	BRISK
90919-01218	DR17YP-1
90919-01219	P7
90919-01220	DR15YP-1
90919-01223	LR17YP
90919-01225	P2
90919-01231	P4
90919-01233	P3
90919-01235	ER15YC-1
90919-01237	P2
90919-01240	P7
90919-01244	A-line 32
90919-T1004	ER15YC-1
90919-YZZAA	A-line 16
90919-YZZAB	A-line 17
90919-YZZAC	A-line 11
90919-YZZAD	A-line 16
90919-YZZAE	A-line 36
90919-YZZAF	A-line 17
90919-YZZAG	A-line 14
UNIPART	BRISK
GSP965Z	DR15YP-1
GSP131	LR17YC
GSP141	L17YC
GSP151	L15YC
GSP163	L15YC
GSP171	L15YC
GSP181	L14YC
GSP191	L12YC
GSP244	LR17YC
GSP263	LR15YC
GSP264	LR17YC
GSP281	LR14YC
GSP331	G17YC
GSP351	G17YC
GSP361	G15YC
GSP381	G14YC
GSP461	GR15YC
GSP531	N17YC
GSP540	N17C
GSP541	N15YC
GSP571	N14YC
GSP634	DR17YC
GSP664	DR15YC
GSP665	D15YC
GSP684	DR14YC
GSP685	D14YC
GSP761	HR15YC
GSP881	HR15YC
GSP981	F15YC
GSP2004	DR15LC-1
GSP2007	DR15YC
GSP4154	F15YC
GSP4266	N17C
GSP4352	L15YC
GSP4356	N15YC
GSP4362	L15YC
GSP4366	N15YC
GSP4372	L17YC
GSP4376	N17YC
GSP4382	L17YC
GSP4452	LR14YC

UNIPART	BRISK
GSP4462	LR15YC
GSP4472	LR17YC
GSP4552	D14YC
GSP4562	D15YC
GSP4563	G15YC
GSP4573	G17YC
GSP4652	DR14YC
GSP4662	DR15YC
GSP4663	GR15YC
GSP6356	N15YC
GSP6382	L17YC
GSP6452	LR14YC
GSP6462	LR15YC
GSP6468	LR15YC-1
GSP6472	LR17YC
GSP6651	A-line 25
GSP6652	DR15YC
GSP6658	DR14YC-1
GSP6662	DR15YC
GSP6663	GR15YC
GSP6668	DR15YC-1
GSP9652	DR15YP
GSP46515	A-line 25
VALEO	BRISK
10N	N14C
10NH	N14YC
11N	N15C
11NH	N15YC
13N	N17C
13NH	N17YC
64H	L12YC
70H	L14YC
70H3E	LR14TC
76H	L15YC
76H3E	LR15TC
84H	L17YC
88N	N17YC
90H	L17YC
C10H	G14YC
C11H	G15YC
C60H	G12YC
C64H	G14YC
C68H	G15YC
C72H	G15YC
F70H	D12YC
F72H	D14YC
F72H3E	DR14TC
F74H	D15YC
F80H	D17YC
F80HDC	D17YC
F82H	D17YC
L11H	L15YC
L11HC	L15YC
L13	L17C
L13H	L17YC
R64H	LR21YC
R70H	LR14YC
R76H	LR15YC
R76H11	LR15YC-1
R84H	LR17YC
R88N	NR17YC



VALEO	BRISK
R90H	LR17YC
RC68H	GR15YC
RC72H	GR15YC
RC72H11	GR15YC-1
RF11HC	DR15YC
RF11HC-1	DR15YC-1
RF13HC	DR17YC
RF13HC-1	DR17YC-1
RF64H	DR14YC
RF72HZ3YE	DR14TC
RF74H	DR15YC
RF74H11	DR15YC-1
RF74H3	DR15TC
RF74HZ	DR15LDC
RF74HZ2	DR15LDC
RF74HZ3YE	DR15TC
RF80H	DR17YC
RF80H11	DR17YC-1
RL11HC	LR15YC
RL13HC	LR17YC
VAUXHALL	BRISK
90 357 729	DR15LDC
90 444 724	DR17LDC-1
90 509 739	DR15LDC
91 132 006	DR15LDC
91 149 686	DR15LDC
VSP 003	DR15LDC
VOLVO	BRISK
109X9146775	DR15LDC
1150278	P2
1346541	LR15YC
1367528	LR15YC
1367529	LR15YC
207X9146775	DR15LDC
22401AA670	P2
270746	LR15YC
270746-1	LR15YC
271409	LR15YC
271603	A-line 28
271727	A-line 28
271758	DR14YP-1
272344	DR15YP
272767	DR15YP
304X9146775	DR15LDC
30637308	DR15YP
30637308791	DR15YP
30637308887	DR15YP
30637385	ER15YS-9
30637385496A	ER15YS-9
30650843	ER15YS-9
30713859	ER15YS-9
30731383	P2
30751469	ER15YS-9
31216297	GR15YP-1
31216525	GR15YP-1
3344898-6	LR15YC
3517980	DR15YC
3650843	ER15YS-9
8670057	DR15YP
8670058	DR15YC
8687990H939	P2

VOLVO	BRISK
8692070	DR15YP
8692071	DR15YP
8692072	DR15YP
8694749	GR15YP-1
9146775	DR15LDC
917910	DR15YP
WOLF	BRISK
1 018 301	P17
2 000 305	PR17
2 016 301	N14C
2 050 324	PR17
2 058 305	JR19
2 085 300	LR15C
2 090 306	LR15YC
4 058 305	JR19
VW GROUP	BRISK
000 435 9424	LR15YC
036 905 605	DOX15LE-1
06H 905 601A	DR14YP
101 000 000 AB	L15YC
101 000 001 AB	LR15TC
101 000 001 AC	LR15TC
101 000 001 AD	LR17TC-1
101 000 001 AE	LR17TC
101 000 002 AB	L15YC
101 000 003 AA	DR14TC
101 000 004 AA	DR14TC
101 000 005 AA	LR15TC
101 000 005 AB	LR15TC
101 000 005 AC	LR14TC
101 000 005 AD	LR17TC-1
101 000 005 AE	LR17TC
101 000 005 AF	LR17TC
101 000 006 AB	L15YC
101 000 006 AC	L15YC
101 000 007 AA	LR15TC
101 000 007 AB	LR15TC
101 000 007 AC	LR17TC-1
101 000 007 AD	LR15TC
101 000 016 AA	DR14YP
101 000 016 AB	DR15YP
101 000 017 AA	DR14TC
101 000 026 AA	LR17TC
101 000 026 AB	LR15TC
101 000 027 AA	LR15TC
101 000 027 AB	LR17TC
101 000 027 AC	LR17TC-1
101 000 028 AA	DR14TC
101 000 031 AA	DR15LDC
101 000 033 AA	DX15LTC-1
101 000 033 AB	DR14TC
101 000 033 AC	DR17TC
101 000 033 AF	DR15TC
101 000 033 AG	DR17TC-1
101 000 034 AA	L15YC
101 000 035 AA	DR17LDC
101 000 035 AB	DR17LDC
101 000 035 AJ	DR15LDC
101 000 036 AA	LR15TC
101 000 036 AB	LR17TC
101 000 036 AC	LR17TC-1

VW GROUP	BRISK
101 000 038 AA	LR17TC
101 000 038 AB	LR17TC
101 000 039 AA	LR17TC
101 000 039 AB	LR17TC
101 000 040 AC	LR17TC
101 000 040 AD	LR15TC
101 000 040 AE	LR17TC-1
101 000 041 AC	DX15LTC-1
101 000 041 AD	DR15TC
101 000 041 AE	DR14TC
101 000 047 AB	LR15YP
101 000 048 AA	N17YC
101 000 049 AC	DR15TC
101 000 049 AD	DX15LTC-1
101 000 049 AF	DR17YC
101 000 050 AA	LR17TC
101 000 050 AB	LR17TC-1
101 000 050 AC	LX15LTC-1
101 000 051 AA	DX15LTC-1
101 000 051 AB	DR14TC
101 000 055 AA	DR15LDC
101 000 060 AA	DR15TC
101 000 062 AB	DOX15LE-1
101 000 063 AA	DR15YP
101 000 063 AC	DR14YP
101 000 065 AA	DX15LTC-1
101 000 067 AA	DR15LDC
101 000 068 AA	DOX15LE-1
101 000 31 AA	DR15LDC
101 905 600	DOX15LE-1
101 905 600 A	P1
101 905 600 R1	DOX15LE-1
101 905 601	DOX15LE-1
101 905 601 B	DOX15LE-1
101 905 601 E	DOX15LE-1
101 905 601 F	DOX15LE-1
101 905 603 B	DOX15LE-1
101 905 607	DR15LDC
101 905 611	DR15YP-1
101 905 611 A	DR15YP-1
101 905 611 C	DR14YP
101 905 617	DOX15LE-1
101 905 617 C	DOX15LE-1
101 905 617 R1	DOX15LE-1
101 905 618	DOX15LE-1
101 905 618 A	DOX15LE-1
101 905 626	P1
101 905 631 C	DR15YP
400 905 619	DR14YP
BBC057010	D15YC
BBC057012	DR15YC
N 017 801 1	N17C
YAMAHA	BRISK
90793-20018	L10S
90793-20032	L10S
90793-20039	N15YC
90793-20040	LR17YC-1
90793-20045	LR15YC-1
90793-20053	B08S
90793-20057	NR15C
90793-20058	NR14C-1



YAMAHA	BRISK	YAMAHA	BRISK	YAMAHA	BRISK
90793-20060	LR15C	90890-78064	NAR12YS	94700-00411	AR12YS
90793-20062	LR12YC	90890-78071	N12YC	94700-00835	NAR14YC
90793-20065	A-line 9	90890-78074	P17	94700-00835-00IV	NAR14YC
90793-20066	A-line 38	90890-78075	P15	94700-00840	AR14YC
90793-20067	A-line 2	90890-78076	P18Y	94700-00841	NAR15YS
90793-20068	A-line 10	90890-78078	LR14YP	94700-00850	NAR15YS
90793-20069	LR14YC-1	90890-78079	LR15YP	94700-00850-00IV	NAR15YS
90793-20071	NAR14YC	90890-78082	L10S	94700-00856	NAR14YC
90793-20071	NAR14YS	90890-78086	LR14C	94700-00879	NAR15YS
90793-20072	NAR12YS	90890-78094	N15C	94701-00039	N15C
90793-20076	BR14S	90890-78102	P17	94701-00040	N14C
90793-20077	BR12S	90890-78106	LR14YP	94701-00041	N14C
90793-20080	BR14YC-9	90893-22113	LR15YP-1	94701-00042	N12C
90793-20083	BR12YP	94700-00039	N15C	94701-00043	L15C
90793-20084	BR10YS-9	94700-00040	N14C	94701-00044	L14C
90793-20090	P15Y	94700-00041	N14C	94701-00045	L14C
90793-20098	PR15Y	94700-00043	L15C	94701-00046	LR12C
90793-20106	LR17YP	94700-00044	L14C	94701-00050	N14YC
90793-20107	LR15YP	94700-00045	L14C	94701-00069	N17C
90793-20108	LR17YP-1	94700-00050	N14YC	94701-00078	L17C
90793-20109	LR15YP-1	94700-00108	N15YC	94701-00108	N15YC
90793-20110	LR14YP	94700-00110	NR14C	94701-00110	NR14C
90793-20116	LR17YP	94700-00111	LR15C	94701-00111	LR15C
90793-20117	LR15YP	94700-00117	L14YC	94701-00112	LR14C
90793-20119	BR12YP	94700-00118	L12YC	94701-00116	L15YC
90793-20120	BR10YS-9	94700-00157	B12C	94701-00117	L14YC
90793-20122	AR12YS	94700-00168	N17YC	94701-00118	L12YC
90793-20123	AR10S	94700-00189	B14C	94701-00157	B12C
90793-20124	AR12YS	94700-00195	NR14C	94701-00160	N14C-1
90793-20125	AR10S	94700-00198	NR15YC	94701-00168	N17YC
90793-20127	LR14YC-1	94700-00203	BR12S	94701-00188	LR12C
90793-20128	LR17C	94700-00204	LR12C	94701-00189	B14C
90793-20131	NR17C	94700-00208	BR14S	94701-00194	NR17YC
90793-20132	NAR15YS	94700-00218	LR14YC	94701-00195	NR14C
90793-20133	NAR14YS	94700-00219	LR12YC	94701-00198	NR15YC
90793-20134	LR12SL	94700-00227	NR14YC	94701-00203	BR12S
90793-20135	LR11SL	94700-00234	LR15YC	94701-00204	BR12S
90793-20136	LR10SL	94700-00241	BR12YC-9	94701-00208	BR14S
90793-20138	LR15YP	94700-00248	NR15C	94701-00211	PR18Y
90793-20140	LR10S	94700-00250	NAR14YC	94701-00217	N14C-1
90793-20150	AR12YS	94700-00254	NAR14YC	94701-00218	LR14YC
90793-20154	BR12YP	94700-00256	NAR15YS	94701-00219	LR12YC
90793-20155	BR10YS-9	94700-00261	LR12C	94701-00227	NR14YC
90793-20167	LR17YP	94700-00262	BR14YC-9	94701-00234	LR15YC
90793-20168	LR15YP	94700-00263	BR14YC-9	94701-00241	BR12YC-9
90793-22008	L17C	94700-00268	N12YC	94701-00247	NR14C-1
90793-22010	LR12C	94700-00275	BR12YC-9	94701-00248	NR15C
90793-22031	NR14C	94700-00280	NR12YC	94701-00250	NAR14YC
90793-22032	NR14C	94700-00282	NAR15YS	94701-00251	NR12C
90793-22033	NR14C-1	94700-00318	AR10S	94701-00254	NAR14YC
90793-22034	NR14C-1	94700-00330	AR12YS	94701-00256	NAR15YS
90793-22035	LR15C	94700-00333	BR12S	94701-00262	BR14YC-9
90793-22036	LR14C	94700-00336	NR17YC	94701-00263	BR14YC-9
90793-22037	LR12C	94700-00340	BR10S	94701-00266	B10C
90793-22039	NR14C	94700-00345	BR14S	94701-00267	L12YC
90793-22045	A-line 10	94700-00353	AR14YS	94701-00268	N12YC
90793-22047	BR14YC-9	94700-00361	BR10YS-9	94701-00275	BR12YC-9
90793-22099	BR12YP	94700-00366	NAR14YC	94701-00280	NR12YC
90793-22100	BR10YS-9	94700-00372	NAR15YS	94701-00282	NAR15YS
90793-22101	LR14YP	94700-00397	N12C	94701-00284	LR15YP
90793-22112	LR17YP-1	94700-00410	AR10S	94701-00285	LR15YP



YAMAHA	BRISK
94701-00287	BR12S
94701-00311	LR17C
94701-00315	AR10S
94701-00318	AR10S
94701-00324	LR115L
94701-00325	L115L
94701-00328	LR17YC
94701-00330	AR12YS
94701-00333	BR12S
94701-00340	BR10S
94701-00345	BR14S
94701-00349	LR14C
94701-00353	AR14YS
94701-00354	NAR17
94701-00356	LR12SL
94701-00358	AR14YS
94701-00361	BR12YC-9
94701-00366	NAR14YC
94701-00371	NR14C-1
94701-00372	NAR15YS
94701-00395	AR10S
94701-00403	AR10S
94701-00410	AR10S
94701-00411	AR12YS
94701-00N02	L115L
94702-00039	N15C
94702-00040	N14C
94702-00041	N14C
94702-00044	L14C
94702-00045	L14C
94702-00046	LR12C
94702-00069	N17C
94702-00111	LR15C
94702-00149	N14C
94702-00160	N14C-1
94702-00188	LR12C
94702-00195	NR14C
94702-00204	LR14C
94702-00211	PR18Y
94702-00217	N14C-1
94702-00217-1	N14C-1
94702-00227	NR14YC
94702-00234	LR15YC
94702-00247	NR14C-1
94702-00248	NR15C
94702-00249	NR17C
94702-00251	NR12C
94702-00271	NR14C-1
94702-00272	NR14C
94702-00323	LR12SL
94702-00324	LR115L
94702-00325	L115L
94702-00326	LR12SL
94702-00331	LR17YC
94702-00343	LR17C
94702-00349	LR14C
94702-00351	L12YC
94702-00356	LR12SL
94702-00357	LR11S
94702-00367	L10SL
94702-00368	LR10SL

YAMAHA	BRISK
94702-00374	D10IR
94702-00383	LR115L
94702-00384	LR105L
94702-00391-0	N15C
94702-00399	DR14YC-1
94702-00400	ER15YC-1
94702-00401	DR15YC-1
94702-00409	AR10S
94702-00412	A-line 28
94702-00427	ER15YC-1
94702-00808	LR14C
94703-00039	N15C
94703-00040	N14C
94703-00041	N14C
94703-00042	NR12C
94703-00043	L15C
94703-00044	L14C
94703-00045	L14C
94703-00046	LR12C
94703-00050	N14YC
94703-00069	N17C
94703-00078	L17C
94703-00108	N15YC
94703-00110	NR14C
94703-00112	LR14C
94703-00114	L10S
94703-00116	L15YC
94703-00117	L14YC
94703-00118	L12YC
94703-00133	L17YC
94703-00157	BR12S
94703-00159	N17YC
94703-00160	N14C-1
94703-00168	N17YC
94703-00181	B12C
94703-00188	LR12C
94703-00189	B14C
94703-00191	L17YC
94703-00194	NR17YC
94703-00198	NR15YC
94703-00203	BR12S
94703-00204	LR14C
94703-00207	L19
94703-00214	NAR15YS
94703-00216	NAR14YC
94703-00217	N14C-1
94703-00218	LR14YC
94703-00220	LR14YC
94703-00222	BR12S
94703-00223	N15YC
94703-00227	NR14YC
94703-00234	LR15YC
94703-00241	BR12YP
94703-00254	NAR14YS
94703-00256	NAR15YS
94703-00258	NR17YC
94703-00262	BR14YC-9
94703-00263	BR14YC-9
94703-00265	NAR14YC
94703-00266	B10C
94703-00267	L12YC

YAMAHA	BRISK
94703-00275	BR12YP
94703-00277	L115L
94703-00279	LR12SL
94703-00282	NAR15YS
94703-00307	AR10S
94703-00311	LR17C
94703-00314	AR12YS
94703-00315	AR10S
94703-00318	AR10S
94703-00319	AR10S
94703-00320	LR14TC-1
94703-00323	LR12C
94703-00325	L10S
94703-00327	NR14YC
94703-00328	LR17YC
94703-00329	AR12YS
94703-00330	AR12YS
94703-00331	LR17YC
94703-00333	BR12S
94703-00340	BR10S
94703-00343	BR14S
94703-00345	BR14S
94703-00352	AR14YS
94703-00353	AR14YS
94703-00355	NR14C
94703-00410	AR10S
94703-00411	AR12YS
94709-00195	NR14C
94709-00211	PR18Y
94709-00247	NR14C-1
94709-00248	NR15C
94709-00271	NR14C-1
94709-00324	L10S
94709-00326	LR12SL
94709-00357	LR11S
94709-00383	LR115L
94709-00384	LR105L
94709-00391	ER15YC-1
94709-00399	DR14YC-1
94709-00400	ER15YC-1
94709-00401	DR15YC-1
94709-00409	AR10S
YANMAR	BRISK
124190-78010	LR17YC
160110-78011	N15C
160232-78010	N19C
160690-78010	L15YC
160690-78020	L17YC
160693-78010	LR15YC
160793-78010	LR17YC
160810-78010	NR17YC
160998-78010	A-line 2

**STANDARD
BRISK**
**ALTERNATIVE
BRISK**
LAST INFO
DOLMAR
ELEKTROCENTRÁLY / STACIONÁRNÍ MOTORY • ELEKTROCENTRALS / STATIONARY ENGINES • ЭЛЕКТРИЧЕСКИЕ КОММУТАТОРЫ / СТАЦИОНАРНЫЕ ДВИГАТЕЛИ

PC - 6212, PC - 6214, PC - 7312 0,5 PR15Y CLASSIC PR17YC SUPER

MOTOROVÉ PILY • CHAINSAW • МОТОПИЛЫ

111i 0,5 PR15Y CLASSIC PR17YC SUPER

PS - 342 0,6 PR18Y CLASSIC

PS - 420 0,5 PR15Y CLASSIC PR17YC SUPER

PS - 4605, PS - 5105, PS - 7310, PS - 7910 0,5 PR15Y CLASSIC PR17YC SUPER

HUSQVARNA
KŘOVINOŘEZY • BRUSH CUTTERS • ТРИММЕРЫ

336FR, 343R 0,5 PR15Y CLASSIC PR17YC SUPER

533RS, 543RS 0,9 TR14C SUPER TR14S SILVER

553RS 0,6 TR14C SUPER TR14S SILVER

MOTOROVÉ PILY • CHAINSAW • МОТОПИЛЫ

135, 135e 0,5 PR17Y CLASSIC PR17YC SUPER

240 0,5 PR17Y CLASSIC PR17YC SUPER

327 P4, 327 PT55 0,5 PR15Y CLASSIC PR17YC SUPER

353G, 353 E-tech, 353G E-tech 0,5 PR17Y CLASSIC PR17YC SUPER

359G, 359 E-tech, 359G E-tech 0,5 PR17Y CLASSIC PR17YC SUPER

365 X-Torq 0,5 PR15Y CLASSIC PR17YC SUPER

372XP X-Torq, 372XPG X-Torq, 372XPW 0,5 PR17Y CLASSIC PR17YC SUPER

390XPG, 390XPW 0,5 PR17Y CLASSIC PR17YC SUPER

395XPG, 395XPW 0,5 PR17Y CLASSIC PR17YC SUPER

440, 450 0,5 PR17Y CLASSIC PR17YC SUPER

543XP TR14C SUPER TR14S SILVER

545, 545Fx 0,5 TR15C SUPER

550XP, 550XP Trio Brake, 550XPG, 556 0,5 TR15C SUPER

562XP, 562XPG 0,5 TR15C SUPER

576XPW, 576XPW AutoTune 0,5 PR17Y CLASSIC PR17YC SUPER

Rancher 450, Rancher 455, Rancher 460 0,5 PR17Y CLASSIC PR17YC SUPER

T 540XP TR15C SUPER

MOTOROVÉ PLOTOSTŘIHY • HEDGE TRIMMERS • КУСТОРЕЗЫ

122HD 60 0,5 SR15C SUPER

123HD 65X 0,5 PR18Y CLASSIC

327HE 3X 0,5 PR15Y CLASSIC PR17YC SUPER

OLEO-MAC (EМАК)
KŘOVINOŘEZY • BRUSH CUTTERS • ТРИММЕРЫ

730S, 730T, 735S, 735T, 740S, 740T 0,5 PR15Y CLASSIC PR17YC SUPER

746S, 746T, 753S, 753T, 755 Master 0,5 PR15Y CLASSIC PR17YC SUPER

PARTNER
MOTOROVÉ PILY • CHAINSAW • МОТОПИЛЫ

351 CCS, 365 CCS, 370 CCS, 390 CCS 0,5 PR17Y CLASSIC PR17YC SUPER

405 CCS, 410, 410 CCS, 420 CCS 0,5 PR17Y CLASSIC PR17YC SUPER

460 CCS, 470 CCS 0,5 PR17Y CLASSIC PR17YC SUPER

500 Formula, 510 CCS 0,5 PR15Y CLASSIC PR17YC SUPER

540, 540 PRO, 660 PRO 0,5 PR15Y CLASSIC PR17YC SUPER

933, 944, 946, 947 0,7 U17Y CLASSIC

1610, 1611, 1613, 1614C, 1616C 0,7 U17Y CLASSIC

1612, 1618 0,7 U17 CLASSIC

1629, 1630, 1631 0,5 K17C SUPER

1632C, 1633B, 1646C, 1647C, 1655B 0,5 PR15 CLASSIC

1644, 1645, 1660, 1661, 1690 0,6 K17C SUPER

1705, 1712 0,7 U17Y CLASSIC

2055B 0,5 PR15 CLASSIC

7000 0,5 PR17 CLASSIC

7700 PRO CCS 0,5 PR15Y CLASSIC PR17YC SUPER

B 17, B 172, B 173 0,5 P15 CLASSIC

B 400 0,5 P17 CLASSIC



PARTNER				
MOTOROVÉ PÍLY • CHAINSAW • МОТОПИЛЫ				
C-6	0,5	P15	CLASSIC	
F 55A, F65	0,5	P15	CLASSIC	
K 12S	0,5	PR15Y	CLASSIC	PR17YC SUPER
K 16	0,5	P17	CLASSIC	
K 550, K 650, K 700, K 1200	0,5	PR15Y	CLASSIC	PR17YC SUPER
P 500, P 5000	0,7	U17Y	CLASSIC	
P 7000	0,5	P15	CLASSIC	
Partner Mini P2	0,5	P15	CLASSIC	
Partner Mini P34	0,7	U17	CLASSIC	
R 14TS, R 15, R 17T, R 18T, R 19T, R 20T, R 85	0,5	P15	CLASSIC	
R 21T	0,5	PR17Y	CLASSIC	PR17YC SUPER
SOLO				
KŘOVINOŘEZY • BRUSH CUTTERS • ТРИММЕРЫ				
105	0,6	PR17Y	CLASSIC	PR17YC SUPER
104L, 107B, 107L, 109B, 109L, 111B, 111L	0,5	TR14C	SUPER	
129B, 129LTS	0,5	PR15Y	CLASSIC	PR17YC SUPER
130H (engine Honda GX 35)	0,6	TR17	CLASSIC	TR17C SUPER
142SB, 152SB	0,5	PR15Y	CLASSIC	PR17YC SUPER
143L	0,6	PR18Y	CLASSIC	
145B, 145L	0,5	PR15Y	CLASSIC	PR17YC SUPER
155	0,5	PR15Y	CLASSIC	PR17YC SUPER
MOTOROVÉ PÍLY • CHAINSAW • МОТОПИЛЫ				
665	0,5	PR15Y	CLASSIC	PR17YC SUPER
681, 681H	0,5	PR15Y	CLASSIC	PR17YC SUPER
MOTOROVÉ POSTŘIKOVAČE • PROPELLED SPRAYERS • ОПРЫСКИВАТЕЛИ С ДВИГАТЕЛЕМ				
432, 433, 444	0,5	PR15Y	CLASSIC	PR17YC SUPER
STIHL				
KŘOVINOŘEZY • BRUSH CUTTERS • ТРИММЕРЫ				
HS 46, HS 46C, HS 56C	0,5	TR15C	SUPER	
MOTOROVÉ PÍLY • CHAINSAW • МОТОПИЛЫ				
MS 192TC-E	0,5	PR15Y	CLASSIC	PR17YC SUPER
MS 201, MS 201CE, MS 201T, MS 201TC-E	0,5	TR15C		
MS 241CM, MS 241CBEM, MS 241CMQ, MS 241CMVW	0,5	TR15C		
MS 260C, MS 260C-B, MS 260C-BW, MS 260D	0,5	PR15Y	CLASSIC	PR17YC SUPER
MS 260DW, MS 260VW, MS 260W	0,5	PR15Y	CLASSIC	PR17YC SUPER
MS 261, MS 261C-BE, MS 261C-Q, MS 261C-VW	0,5	PR15Y	CLASSIC	PR17YC SUPER
MS 271, MS 271C-BE	0,5	PR15Y	CLASSIC	PR17YC SUPER
MS 280C-B, MS 280C-BQ	0,5	PR15Y	CLASSIC	PR17YC SUPER
MS 291, MS 291C-BE, MS 291C-BEQ	0,5	PR15Y	CLASSIC	PR17YC SUPER
MS 311, MS 362, MS 391	0,5	PR15Y	CLASSIC	PR17YC SUPER
MS 441, MS 441C-M, MS 441C-MW, MS 441C-Q, MS 441W	0,5	PR15Y	CLASSIC	PR17YC SUPER
MS 461, MS 641VW, MS 660W	0,5	PR15Y	CLASSIC	PR17YC SUPER
VARI				
MOTOROVÉ TRAVNÍ SEKAČKY • LAWN MOWER • СЕНОКОСИЛКИ				
BDR-581SP PERLA (B&S 850 - 6 HP)		DR17YC	SUPER	DR17YS SILVER
BDR-585 ADELA (Honda GCV 160 - 5,5 HP)		DR15YC	SUPER	LR15YS SILVER
BDR-595MF LUCINA (B&S Quantum XM50 - 5 HP)		JR17	CLASSIC	
BDR-595V LUCINA (Tecumseh Centura 55LXT - 5,5 HP)		JR17	CLASSIC	
BDR-620 LUCINA (Honda GCV 190 - 5,1 HP)		LR15YC	SUPER	LR15YS SILVER
BDR-620B LUCINA (B&S 850 - 5,1 HP)		DR17YC	SUPER	DR17YS SILVER
DS-520 LIZA (Tecumseh Centura 55LXT - 5,5 HP)		JR17	CLASSIC	
DS-521 AGATHA (Honda GCV 160 - 4,4 HP)		LR15YC	SUPER	LR15YS SILVER
DS-521B AGATHA (B&S 675 - 3,6 HP)		JR19	CLASSIC	
DS-521H LIZA (Honda GCV 135 - 4,5 HP)		LR15YC	SUPER	LR15YS SILVER
DS-521Z AGATHA (VARI XP 200)		LR15YC	SUPER	LR15YS SILVER

BRISK Tábor a.s., Vožická 2068, 390 02 Tábor, Czech Republic,
tel.: +420 381 492 111, fax: +420 381 492 276, e-mail:brisk@brisk.cz, www.brisk.cz

